



ABC®
INDIA

Regd. Trade Mark
MARK FOR PERFECTION
ESTD. 1958

Scientific Glass Apparatus

for Education, Research and Industry

Effective from
April 2019



NABL

MSME

सूक्ष्म, लघु एवं मध्यम उद्यम
MICRO, SMALL & MEDIUM ENTERPRISES



9001 : 2015

ABC® 25°C ± 2°C USP ± 0.12ml A
INDIA
Boro 3.3 250ml

THE LABORATORY GLASSWARE CO.
An ISO 9001:2015 Certified Company



Certificate

This is to Certify that Good Manufacturing Practice of the

THE LABORATORY GLASSWARE CO.

Office Address :- 3612, Timber Market, Ambala Cantt., Haryana, India - 133001.

Works Address:- 73, HSIIDC, Industrial Estate, Ambala Cantt., Haryana, India - 133001.

Has been assessed and found to be in accordance with the requirements standard detailed below

GMP

This Certificate is valid for the following scope

**Manufacturer, Exporter & Supplier of Scientific Glass Apparatus & Instruments
For Education, Research Institutes and Industries.**

Certificate No : GMP-XIX-09-6425

NACE : DI-26.21

Issue Date : 03-SEP-2019

Valid Until : 02-SEP-2022

A.dpanghal
**Authorised Signatory
WRG Certification**

This certificate remains the property of American International Accreditation Organization-Bureau of Accredited Registrars, (USA)



Validity of the certificate is subject to successful completion of surveillance audits. Further clarification regarding the scope of this certificate and the applicability of standard may be obtained by consulting the WRG Certification Organization, India Aditya Corporate Hub, Raj Nagar, ghaziabad-201002 (U.P.) India, E-mail : wrgcert@gmail.com, website : www.wrgcert.com, www.aiao-bar.org



**National Accreditation Board for
Testing and Calibration Laboratories**

(A Constituent Board of Quality Council of India)



CERTIFICATE OF ACCREDITATION

THE LABORATORY GLASSWARE CO.

has been assessed and accredited in accordance with the standard

ISO/IEC 17025:2017

**"General Requirements for the Competence of Testing &
Calibration Laboratories"**

for its facilities at

73, INDUSTRIAL ESTATE AMBALA CANTT, AMBALA, HARYANA, INDIA

in the field of

CALIBRATION

Certificate Number: CC-3038

Issue Date: 28/08/2019

Valid Until: 27/08/2021

This certificate remains valid for the Scope of Accreditation as specified in the annexure subject to continued satisfactory compliance to the above standard & the relevant requirements of NABL.
(To see the scope of accreditation of this laboratory, you may also visit NABL website www.nabl-india.org)

Signed for and on behalf of NABL



N. Venkateswaran
Chief Executive Officer

MECHANICAL CALIBRATION



Certificate of Compliance

Issued to:

THE LABORATORY GLASSWARE CO.

Carried out at following site:

OFFICE : 3612, TIMBER MARKET, AMBALA CANTT. - 133 001
(HARYANA) (INDIA)
&
WORKS : 73, HSIIDC, INDUSTRIAL ESTATE, AMBALA CANTT.
(HARYANA) (INDIA)

for their:

**QUALITY MANAGEMENT SYSTEM
ISO 9001 : 2015**

SCOPE of Activities covered by this Certificate:

MANUFACTURER, EXPORTER & SUPPLIER OF SCIENTIFIC
GLASS APPARATUS & INSTRUMENTS FOR EDUCATION,
RESEARCH INSTITUTES AND INDUSTRIES

Certificate no. : **EAS/QMS/B1010**
Issued on : **21/02/2018**
Validity Date : **20/02/2021**

1st Surveillance Due On : **21/01/2019**
2nd Surveillance Due On : **21/01/2020**

The validity of certificate is subject to regular surveillance audit on or before above mentioned dates and it's only valid after successful surveillance with continuation letter issued by GA



Acc No.:- EUAC106



Authorized Signatory
Global Assessment

www.theglobalassessment.com

This is multi site certification

Registered Office - HU 1023 Budapest, Becsi ut 3-5. Hungary

The certificate remains the property of Global Assessment Kft and shall be returned immediately upon request.



An ISO 9001 : 2015 Certified Company

SCIENTIFIC GLASS APPARATUS

FOR EDUCATION-RESEARCH AND INDUSTRY

MAILING ADDRESS

3612, Timber Market
Ambala Cantt 133 001



PHONES :

91-171-4000378



GST NO. :

06AABPO6520A1ZB



e-mail : labco_co@yahoo.in,
maillabco@gmail.com

Web : www.labco.biz



THE LABORATORY GLASSWARE CO.

3612, Timber Market, Ambala Cantt-133 001 (INDIA)

Factory: 73, Industrial Estate, Ambala Cantt.

Foreward

We thank to all our worthy patrons & clients who put their faith in our 'LABCO' brand products for the last six decades which encouraged us in presenting herewith our latest Catalogue cum price list.

Chemical Properties : Our Glassware products are fabricated from low alkali borosilicate type 3.3 glass having chemical composition S_1O_2 : 81%, B_2O_3 : 13%, Na_2O/K_2O : 4%, Al_2O_3 : 2% approx by weight except particularly mentioned.

Thermal Properties : Coefficient of linear expansion : 32.5×10^{-7} cm/cm/°C, Strain point : 515°C, Annealing point : 565°C, Softening point : 820°C, Specific heat : 0.2 & Thermal conductivity (Cal/cm³/°C/Sec) : 0.0027

Though said Catalogue covers a long range of our manufactured products, yet we welcome to cater products not listed & of special requirement.

Proper infrastructure, Latest machinery, Volumetric Calibration equipments & well experienced technical staff is engaged to prepare world class glass equipments.

Our's is ISO 9001 : 2015 & GMP certified Organization, having **NABL** (National Accreditation Board for testing & Calibration Laboratories) for Mechanical Calibration of Glassware. We are also Regd. as **SSI** Unit with GM Industry, Govt. of Haryana, Ambala vide Regn. No. AMB/SC/24/I dt. 11.05.1961.

Moreover our unit is Regd. as **MSME** unit having UAM Regn. No. HR01B0004268.

On conclusion, we like to add that we value all our worthy customers suggestion, Guarantee & Warantee for all our manufactured items. We emboss our trademark 'LABCO' on the products which are strictly tested before dispatch. We undertake special care for packing to avoid breakage in transit.

While placing your valued orders, please do mention our Catalogue numbers, minimum Qty/Pack alongwith description.

The Laboratory Glassware Company

3612, Timber Market, Ambala Cantt.- 133001

INDEX

A	
Absorption Bulb	94
Absorption Pipette	110
Absorption Vessel	103
Adapters Various	42-47, 49-50, 100, 114
Agate Mortar & Pestle Black	110
Air Condensers	28
Air Leak Tube	50
Albuminometer Esbash	88
Allihan Condenser	30
Aluminium Foil	98
Aluminium Test Tube Stands	128
All Quartz Glass Distillation Apparatus	66
Amber Glass Vials	27
Ammonia Distillation	69
Ampoules (Various)	92
Anderson Pipette	98
Anaerobic Culture Jar	112
Apron (Disposable)	142
Arsenic App. (Various)	103
Artificial Insemination Pipette	15
Asbestos Gloves	142
Aspirator Bottles	86 & 140
Assemblies Various	63-66
Autoclaves	127
Automatic Burettes	6-9
Auto Variac	120
Automizer Bulb	135
B	
Barometer Digital	108
Beakers (Plain & Graduated)	81, 114, 138
Beakers (Philips)	81
Beakers for Karlfisher	81
Bechman's Freezing Point	98
Beckman's for Molecular Weight	98
Blood Sugar Tubes	88
B.O.D. Bottles	85
Bottles Various	82-87, 114, 138
Bottles General Purpose (Ordinary)	86-87
Bottle Wide Mouth Pouring Ring	85
Bottles Gas Washing	95
Bottle Top Dispensers	113, 114
Boiling Point App. (Beckman)	98
Boiling Tube S Micro	110
Boss Heads	129
Buchhi Flask Evaporator	116
Buchhi Flasks	37
Buchner Funnel	60-61, 137
Buchner Flasks	36 & 39
Bulk Density Cylinders (Vankle's)	23
Bunte Gas Burette	94
Burette Various	1-9
Burettes Automatic for (K.F. Apparatus)	9
Burette Clamp (Plastic)	139
Burettes With Telfon Plugged Staopcock	3-4
Burners	131
Burette Cleaning Brushes	9
Burette Clamps (Mettalic)	129
Butyrometers (Various)	105
C	
Calcium Chloride Tubes	93-94
Calcium Chloride Tower	94
Caloemel Electrodes	97
Carbaryl Content Determination Apparatus	65
Carbon Burette	103
Carbon/Sulphur Glass Parts	103-104
Cavett Flasks for Blood Test	69
Centrifuge Tubes	24-25, 114, 140, 141
Centrifuge Machine	119
Chromatography Columns & App.	74-76
Chromatography Sprayers	101-102
Chloroform Bulb With Net	9
Chloroscope	89
Clamps Various	128-129
Claisen Head Sloping	48
Clevenger App.	71
Clinical Laboratory App.	88-89
Co-Agglutination tubes (Melting Point Tubes)	88
Coil Condenser	28-30
Coil Finger Condensor	30
Colony Counter	118
Columns Fractionating	58
Column Storage Cabinet	103
Cones (Imhoff)	23
Cones (Male Part of Joint)	42-43
Congeaing Temperature Apparatus	64
Continuous Extraction Apparatus	73
Condensers All Types	28-30
Conical Flasks	36, 39-41
Conical Flasks Wide Mouth	40
C.O.D. Digestion App.	126
Concavity Slides	90
Conductivity Cum TDS Meter	124
Conductivity Cell	124
Connecting Tubes	101
Coplin Jars	141

INDEX

Conway Diffusion Unit	91	Drying Tray	41
Counting Chamber	89	Drying Tubes	50
Cover Slips	90	Dumas Bulb	99
Cottrel Brown Boiling Poing App.	98	Durham's Tubes	88
Cork Boring Machine	131		
Cork Borers	131	E	
Crude Fibre Estimation App.	118	Ear Plug	143
Crow Receiver	23	Ear Moff	143
Cryo Vials & Boxes	141	Electrical Distillation (Heater Embedded in Glass App.)	67
Crucible Sintered	60	Electrodes	97
Crucible Tongs	130	Electrodes for Ph Meter	97
Crucible Sleeves for Glass Filtering	135	Elements (Spare)	143
Crystallizing Dishes	41	Equilising Funnels (Pressure)	57-58
Culture Tubes (Plain & Amber Colour)	27	E.S.R.Tubes	15,88
Culture Flasks (Various)	91	Essential Oil Determination App.	71
Cyanide Distillation App.	65	Erlenmeyer Flask Graduated Wide Mouth	40
Cylinders Graduated	19-22, 139	Evaporating Basin Glass	41
Cylinder Rain Measure	23	Evaporating Basin (Porcelain)	137
		Extraction Soxhlet's	73
		Expansion Adapters	45
D			
Davies Condensor	29	F	
Dean & Stark App.	70	Face Mask	142, 143
Delivery Tubes	111	Fermentation Vessel	104
Demineraliser	67	Filter App. Various	60-62
Dewar Vaccum Flasks	101	Filter Holder Assembly (S.S)	62
Dessicators	102, 139	Filter Pump	100
Digestion Tubes	88, 102	Filter Papers	111
Dilatometers	99	Filter Paper Sheets (18"x22")	111
Diamond Point Pencil	98	Filteration Flasks	36-39
Digital Temperature Controller Unit	124	Filter Holder (Manifold Type)	62
Digital Thermometer	106	Filter Tubes	101
Digital Pipettes	113	First Aid Box	143
Digital PH Meter	124	Flasks Evapoator	116
Dirt Correction App.	98	Flask for Buchhi App.	37
Dissolution Vessels	35	Flask Cleaning Brushes	41
Distillation Electrical (Heater in Glass) NPL Design	67	Flasks Measuring Various	16-18
Distillation App. (Quartz)	66	Flasks All Type With Joints	31-41
Distillation Assemblies	63-69	Flask Graduated Conical	40
Distillation Fractionation	65	Flask Haffkine	40
Distillation of Water App.	63, 66-67, 124	Flask Stand (Plastic)	139
Distillation App.Parts	28-50	Fluoride Distillation app.	63
Distillation Reflux	64-65	Forceps	131
Distillation Flasks	38	Formaldehyde Content Determination Apparatus	66
Draining Basket	140	Franz Diffusion Cell	97
Dreyer's Aggulation Tubes	88	Freeze Drying ampoules	92
Dropping Bottles	85-86, 110, 138	Fractionating Columns	58
Dropper (Glass)	110	Fractionation Assemblies	65
Dropper (Disposable)	141		
Dropping Funnels	55-57		
Dry Bath Incubator	121		

INDEX

Frill Cap (Disposable)	142	Infrared Thermometer	107
Funnel Filtering	100 & 139	Inspection Card Viewing Strip	59
Fused Silica Laboratory Ware	112	Impinger Tubes	93
G		Incubators	126
Gas Analysis App.	96	Inoculation Loop With Holder	110
Gas Collecting Tubes	94-95	Insemination Pippettes	15
Gas Delivery Tubes	111	Instrument Cover (Plexi Glass)	76
Gas Desorber	93	Interchangeable Ground Assemblies	63-68
Gas Jars	95	Iodine Flasks	40
Gas Washing Bottles	95	J	
Gas Taps	136	Jacketed Coil Condensers	28-29
General Utility Sets	66	Jacks for Laboratory	136
Glass Beads	59	Jar Rectangular Museum	83-84
Glass Cell (Cuvette)	112	Jars Various Acrylic	84
Glass Engraving Pen, Battery operated	98	Joints Standard	42 & 43
Disposable Syringes	89	Junge's Melting Pt. App.	99
Glassware Dryer	121	K	
Gloves (Various)	142	Kahn's Antigen Dilution Tubes	88
Goggles (Safety)	142	Kettles Resin Reaction	31
Ground Joints Interchangeable	42-43	Khan Test Tube	88
Graduated Test Tubes	26	Kemmer Hellet Nitrogen Distillation Apparatus	72
Grip Clamps	43	K.F. Burette (Automatic)	9
Guides & Glands	52	Kipp's Apparatus	96, 111, 139
H		Kjeldhal Bulb	98
Haemoglobin Tube	89	Kjeldhal Distillation Assembly	71
Haemoglobin Pipette	89	Kjeldhal Distillation & Digestion Apparatus	116-118
Hand Vaccum Pump	62	Kjeldhal Reaction Vessel	127
Heamocytometers	89	Kjeldhal Flasks	36 & 40
Heat Exchanger for Distillation	69	Kjeldhal Digestion Unit	116-117
Haemometer Tube	89	Kjeldhal Absorption Traps	72
Haemometer Set	89	Kjeldhal Digestion Tubes	102
Haemoglobinometer (Sahil's)	89	Kjeldhal Distillation Unit	117
Hemple Gas Burette	94	Kohlrausch Flasks	18
Heating Elements	143	Kozelka & Hine Blood Test Apparatus	69
Heating Mantles	118	Kunderna Danish Evaporators	65
High Pressure Manometer	104	L	
Hoffman Voltmeters	97	Lactometer	105
Hoffman Screw Clips	136	Landsberger App.	98
Hot Plates	119	Lab Coat	142-143
Homogenisers	90	Laboratory Stands, Clamps	128-130
Human Thermometer	107	Laboratory Safety Products	142-143
Hydrometer All Types	108 & 109	Laboratory Telfon Wares	114
Hydroxypropoxy Determination Apparatus	65	Le-Chatelier Flasks	18
I		Leighton Tubes	27
Imhoff Cones	23	Leibig's Condensers	28
Imhoff Cone Stand (Perspex)	23	Lock Stoppers	105

INDEX

M

Mac-Cortney Bottles	88
Majjonier Flasks	105
Magnifying Glass various	111
Magnetic Stirrers	120
Mancozeb Content Assembly	65
Manometers Various	97
Markham Semi Distillation Unit	72
Measuring Cylinders	19-22, 139
Measuring Cylinders (Single Mark)	23
Measuring Flasks	16-18
Measuring Jugs	140
Mecoy's App.	98
Media Bottle (Jam Bottle)	87
Melting Pt. Tube (Theils)	99
Melting Point App.	120
Melting Pt. App (Glass)	99
Memo Glass	59
Melting Point Capillary	59
Mercury Distillation Assembly	65
Mercury Seal Glands & Guides	52
Methoxy Determination Assembly	65
Micro Kjeldhal Distillation	71-72
Micro Nitrogen Determinaion	72
Micro Pipette (Automatic)	113
Microscopic Slides	90
Micropipette Stand	113
Milk Pipette	15
Milk Testing App.	105
Millipore Membrane Filter Holder Assembly	61
Molecular Weight Determination App.	98
Moisture Determination App.	70
Mortar & Pestle (Porcelain)	137
Mortar & Pestle (Agate)	110
Mud Flasks	18
Murphy Drips	88
Multiple Adapters	45
Muffle Furnace (Liht Weight)	124

N

Nessler Cylinders (Plain & Stoppered)	22-23
Nessler Tube Stand	128
Nickle Crucibles	111
Nitrometers Lunge's	94
Nitrogen Determination App.	71-72

O

Occular Micrometer Disc	89
Oil Centrifuge Tubes	25
Oil Bath (High temp.)	123
Oil Free Portable Vaccum Pumps	62
Organ Tubes	89
Orsats Gas Analysis App.	96
Osmotic Pressure App.	104
Ovens	125
Ovens (Vaccum)	125-126
Oxygen Determination Assembly	96
Oxygen Purifying Assembly	104
Oxygen Combustion Flasks	98
Oxygen Tubes	89

P

Paking for Columns	59
Packing Support	59
Particle Size Determination App.	98
Paper Chromatography Cabinet	115
Pasteur Pipettes	15
Pear Shapped Flasks (All Type)	37-38
Perkin'sTriangle	47
Pestle & Mortar (Porcelain)	137
Petri Dishes	91, 141
Petri Dishes (Poly)	141
Photosynthesis App.	104
Ph Meter	124
Ph Meter (Glass)	97
Pipette Box (Plastic)	139
Pipette Washers	119
Pipette Various	10-15
Pipettes Bulbs Rubber	15 & 135
Pipette Can (Metallic)	128
Pipette Pump	140
Pipette Stand	138
Plant Physiology App.	104
Platinum Wire Fused	110
Plasticware	138-141
Polarimeters Tubes	100
Polenske's Apparatus	105
Police Man Silicon Rubber	135
Porecelain Ware	137
Pollution Apparatus	93
Potometer Various	104
Preparation Assembly	63
Pressure Equalising Funnels	57-58
Propiptor (Natural)	135
Propiptor (Silicon)	135
Psychrometer	108
P.V.C. Rubber tubing	134
Pyknometers	99

INDEX

Q		
Quartz Distillation App.	66	
Quartz Cell	112	
R		
Rasching Rings	59	
R.B.C. Pipette	89	
Reaction Assemblies	64	
Reaction Vessel (Kjeldhal)	127	
Reactor Glass	31	
Reagent Bottles	84-85	
Receiver Adapters	46-47	
Recovery Bend Sloping	47	
Recovery Assemblies	64	
Reduction Adapters	44,114	
Reflux Assemblies	64-65	
Reichert Wolleny's App.	105	
Reservoir for Chromatography Column	76	
Respirometer	104	
Respiroscope	104	
Retort Stand (Plastic)	138	
Retorts	100	
Retorts Rings	130	
Ria Vials	141	
R.M.Value App.	105	
Root Pressure App.	104	
Rotary Vaccum Evaporators	116	
Rotary High Vaccum Pumps	127	
Rotary Flask Shakers	121	
Roux Culture Bottles	86	
Rubber Sleeve Glands	52	
Rubber Sheet	136	
Rubber Tubes	133	
Rubber Teat for Dropper	135	
Rubber Corks	136	
Rubber Cones for Filtration Flasks	135	
S		
Sampler (Glass)	35	
Sampling Spoon (S.S)	131	
Schoinger Flasks	98	
Scissor	131	
Screw Clips (Hoffman)	136	
Sealing Machine (Polythene Sealing)	76	
Sealing Machine (Vial Sealing & Desealing)	76	
Sedimentation Pipettes	98	
Sedimentation Cylinders	23	
Semi Micro Analysis App.	110-111	
Separating Funnels	53-58	
Separating Funnels With Telfon Stopcock	53-54	
Shaking Machines	121	
Shoe Cover (Disposable)	142	
Sintered Glassware	60-62	
Silicon Cork for Mojjonier Flask	105	
Silica Basins	112	
Silica Crucible	112	
Silicon Pipette Filler (Bulb)	15	
Silicon Rubber Tubing	133	
Silicon Rubber Cork	134	
Silicon Rubber, Safety Rider for Vol. Flask	18	
Silicon Vaccum Greese	98	
Sintered Crucibles	60	
Slides (Microscopic)	90	
Sockets (Female Parts)	42-43	
Soil Survey Instrument	108	
Solid Changing Funnel	100	
Solvents Recovery Assemblies	65	
Soxhlet's Extraction App.	73	
Soxhlet's Heating Unit	118	
Soil Moisture Gauge	70	
Spatula	102,110,114,130 & 131	
Specific Gravity Bottles	83	
Specimen Jars	102	
Speed Regular Box (For Mechanical Stirrers)	120	
Spiral Condensors	28-30	
Spirit Lamp	111	
Splash Heads	48	
Splash Head Adapters for Rotavaps	37	
Spherical Joints	43	
Spreader (Glass)	89	
Spreader (Poly)	141	
Stage Micrometer	89	
Stalaganometer	99	
Stands & Clamps	128-130	
Steam Distillation Heads	48	
Steam Distillation Assemblies	63	
Sterility Tubes & Stand	26	
Storage Boxes (Poly)	140	
Storage Vials	141	
Shaking Machines	121	
Stirrers Various	51-52,114,120	
Stirrers Guides	52	
Stirring Rods	51,114	
Stirrers & Magnetic Stirrers	120	
Still Heads	47	
Stoppers Various	43-44,114	
Stopcocks All Types	77-80	
Stuffing Box Glands	52	
Suba Seal Stopper	134-135	
Suba Seal Stopper (Turnover Flange Septa)	134-135	

INDEX

Sugar Flasks (Percentage)	18
Sulphur Burette	103
Sulphur Dioxide Assembly	64
Sulphonation Flask	18
Swan Neck Adapters	45
Swan Neck Taps	131
Syphon	100
Syringe (Disposable)	89
Syringe Stand	89

T

Tap Funnels	53-58
TDS Meter	124
Telfon Coated Magnetic Beeds	114
Telfon Bladed Stirrers	51
Telfon Blade for Stirrers (Spare)	51
Telfon Stopcocks	78-79
Temperature Control Unit (Digital)	124
Test Tube Graduated	25-26
Test Tube With or Without Stoppers	25-26
Test Tube All Types	25-27,114
Test Tube Holder (S.M)	110
Test Tube Baskets	140
Test Tube Brushes	110
Test Tubes Stands (Alluminum)	128
Test Tube Stand (Plexi Glass)	128
Test Tubes Shaker (Electrically Operated)	121
Thermometers Pockets	50
Thermometer All Types	106-108
Theil's Tube Melting Pt.	99
Thistle Funnels	100
Tissue Homogeniser	90.110
Tilt Measure	15
T.L.C Apparatus	115
T.L.C. Chamber	76
Titer Test Apparatus	65
Tongs Various	130-131
Trays (Enameled)	132
Trays (Poly)	140
Tripod Stands	130
Transport Number App.	97
Tubes Various	24-27,114
Tutwiler Gas Burette	98-94
Trysinising Flasks	91

U

Ultraviolet Inspection Cabinet	115
Ureometers	88
Utility Sets As Per Quikfit & Quartz	66

V

Vaccum Distillation Assemblies	63-64
Vaccum Drying Pistol	65
Vaccum Flasks	36 & 39
Vaccum Fractionation	65
Vaccum Oven	125-126
Vaccum Stopcocks	79-80
Vaccum Receiver Adapters	46
Vaccum Sublimation	65
Vaccum Pump for Filtration	62,100
Vaccum Pumps (Elctrically Operated)	62,127
Vacustat Gauge (Mc-Leod Gauge)	97
Variac Auto Transformer Various	120
Vapour Density App.	98
V.D.R.L. Bottles	88
V.D.R.L. Concavity Slides	90
V.D.R.L. Rotator	121
Vertical Autoclaves	127
Vials (Various)	27,87,88,141
Vial cabinet (Perspex)	59
Vidal Tubes	88
View Bulb	104
Victor Meyer App.	98
Viscometers	99
Volumetric Flasks	16-18
Voltameter Water (Hoffman)	97
Volatile Acid Determination App.	105
Vortex Shaker	121

W

Wash Bottle (Glass)	99
Wash Bottles Plastic	138
Watch Glass	111
Water Baths	111,122-123
Water Stills (Metal)	124
Water Still (All Glass)(Silica Sheathed Heaters)	68
Water Distillation App. (All Glass)	66-68
Water Softener	67
Wasserman Tubes	88
Weighing Bottles	82-83
Weight Boxes	132
Willmout Bubbler	104
Wintrade Tubes	88
Wire Gauze	111
Wilt's Filtering App.	60
Weighing Scoops	102
Weight Thermometer	99
Working Tray (S.S)	59
Woulf's Bottles	87
W.B.C. Pipette	89

VOLUMETRIC / GRADUATED GLASSWARE

BURETTES

501. Burettes with Pinch Cock, "LABCO", Rubber tubing and glass jet, Accuracy as per Class 'B' of I.S. 1997 : 2008.

Cat.No.	Capacity ml.	Sub. Div. ml.	Tolerance \pm ml.	Min. Qty./pack	Price/Piece Rs.
501/1	**10	0.05	0.05	10	220-00
501/2	25	0.10	0.10	10	200-00
501/3	50	0.10	0.10	10	205-00
501/4	100	0.20	0.20	10	210-00

502. Burettes with Straight Bore Glass Key Stopcock, "LABCO", Accuracy as per Class 'A' of I.S. 1997 : 2008 with works certificate.

Cat. No.	Capacity ml.	Sub. Div. ml.	Tolerance \pm ml.	Min. Qty./pack	Price/Piece Rs.
502/1	**1	0.01	0.006	2	1050-00
502/2	**2	0.02	0.010	2	1050-00
502/3	**5	0.02	0.010	2	950-00
502/4	**10	0.05	0.020	2	845-00
502/5	25	0.10	0.050	2	750-00
502/5a	25	0.05	0.030	2	920-00
502/6	50	0.10	0.050	2	760-00
502/7	100	0.20	0.100	2	780-00

** with Cup Top

502L. Burettes with Straight Bore Glass Key Stopcock, "LABCO", Accuracy as per Class 'A' of I.S. 1997 : 2008 with **NABL** certificate.

Cat. No.	Capacity ml.	Sub. Div. ml.	Tolerance \pm ml.	Price/Piece Rs.
502L/1	**1	0.01	0.006	1675-00
502L/2	**2	0.02	0.010	1675-00
502L/3	**5	0.02	0.010	1675-00
502L/4	**10	0.05	0.020	1675-00
502L/5	25	0.10	0.050	1625-00
502L/6	50	0.10	0.050	1675-00
502L/7	100	0.20	0.100	1650-00

** with Cup Top, + Not Covered in IS.

502M Amber Colour Burettes, With Straight Bore Glass Key Stopcock, "LABCO", accuracy as per Class 'A' of I.S. 1997 : 2008

Cat. no.	Cap. ml.	Sub Div ml.	Min. Qty./Pack	Price/Piece Rs.
502M/1	1	0.01	4	1050-00
502M/2	2	0.02	4	1050-00
502M/3	5	0.05	4	1050-00
502M/4	10	0.05	4	1050-00
502M/5	25	0.10	4	1100-00
502M/6	50	0.10	4	1160-00
502M/7	100	0.20	4	1200-00

* With cup top.

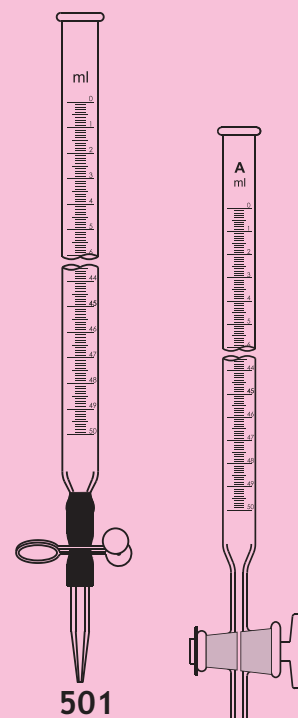

501

502

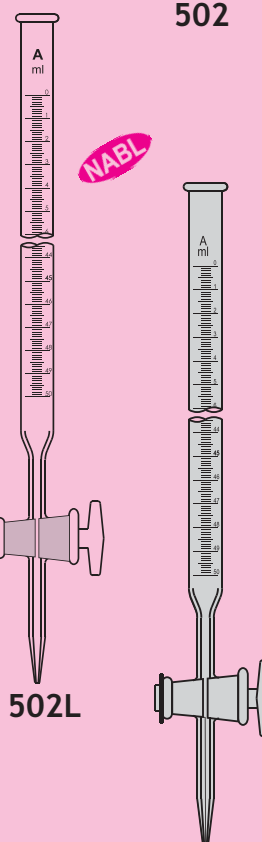

502L

502M

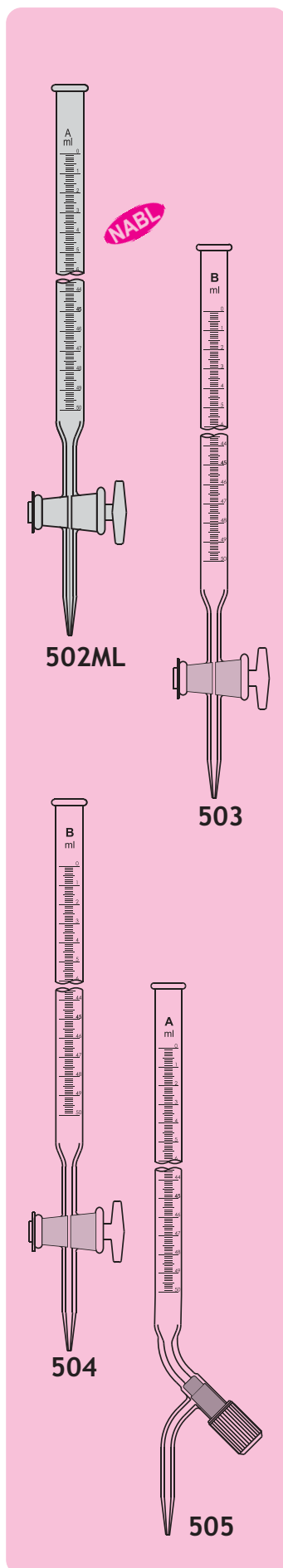

502ML Amber Colour Burettes, "LABCO", With Straight Bore Glass Key Stopcock. Accuracy as per I.S. 1997 : 2008 **Class 'A'** with **NABL** Certificate.

Cat. no.	Cap. ml.	Sub Div ml.	Tolerance ± ml.	Class A Glass key	Class A PTFE key
502ML/1	1	0.01	0.006	1775-00	1950-00
502ML/2	2	0.02	0.01	1775-00	1950-00
502ML/3	5	0.05	0.01	1775-00	1950-00
502ML/4	10	0.05	0.02	1775-00	1950-00
502ML/5	25	0.10	0.05	1700-00	1900-00
502ML/6	50	0.10	0.05	1775-00	1950-00
502ML/7	100	0.20	0.10	1775-00	2000-00

* With cup top.

503. Burettes with Straight Bore Glass Key Stopcock, "LABCO", Accuracy as per Class 'B' of I.S. 1997 : 2008

Cat No.	Capacity ml.	Sub. Div. ml.	Tolerance ± ml.	Min. Qty./Pack	Price/Piece Rs.
503/1	**1	0.01	0.01	6	470-00
503/2	**2	0.02	0.02	6	470-00
503/3	**5	0.02	0.02	6	370-00
503/4	**10	0.05	0.05	6	370-00
503/5	25	0.10	0.10	10	355-00
503/6	50	0.10	0.10	10	370-00
503/7	100	0.20	0.20	6	450-00

** with Cup Top

504. Burettes with Straight Bore Glass Key Stopcock, "LABCO", Accuracy as per Class 'B' of I.S. 1997 : 2008. Routine Quality (Light Wall).

Cat No.	Capacity ml.	Sub. Div. ml.	Tolerance ± ml.	Min. Qty./Pack	Price/Piece Rs.
504/1	25	0.10	0.10	10	295-00
504/2	50	0.10	0.10	10	330-00
504/3	100	0.20	0.20	10	410-00

505. Burettes with Screw Type Rotaflow Stopcock with PTFE key, "LABCO", Accuracy as per Class 'A' of I.S. 1997 : 2008.

Cat. No.	Capacity ml.	Sub. Div. ml.	Tolerance ± ml.	Min. Qty./Pack	Price/Piece Rs.
505/1	**1	0.01	0.006	2	1000-00
505/2	**2	0.02	0.010	2	1000-00
505/3	**5	0.02	0.010	2	925-00
505/4	**10	0.05	0.020	2	800-00
505/5	25	0.10	0.050	2	710-00
505/5a	25	0.05	0.030	2	900-00
505/6	50	0.10	0.050	2	725-00
505/7	100	0.20	0.100	2	750-00

** with Cup Top

505L. Burettes with Screw Type, PTFE Needle Valve Stopcock, "LABCO", Accuracy as per Class 'A' of I.S. 1997 : 2008. with NABL certificate.

Cat. No.	Capacity ml.	Sub. Div. ml.	Tolerance ± ml.	Price/Piece Rs.
505L/1	**1	0.01	0.006	1675-00
505L/2	**2	0.02	0.010	1675-00
505L/3	**5	0.02	0.010	1675-00
505L/4	**10	0.05	0.020	1675-00
505L/5	25	0.10	0.050	1625-00
505L/6	50	0.10	0.050	1675-00
505L/7	100	0.20	0.100	1650-00

**** with Cup Top, + Not Covered in IS.**

506. Burette with Screw Type Rotaflow Stopcock with PTFE key, "LABCO", Accuracy as per Class 'B' of I.S. 1997 : 2008. (Medium wall heavy type)

Cat. No.	Capacity ml.	Sub. Div. ml.	Tolerance ± ml.	Min. Qty./Pack	Price/Piece Rs.
506/1	**1	0.01	0.01	6	460-00
506/2	**2	0.02	0.02	6	460-00
506/3	**5	0.02	0.02	6	365-00
506/4	**10	0.05	0.05	6	365-00
506/5	25	0.10	0.10	10	355-00
506/6	50	0.10	0.10	10	370-00
506/7	100	0.20	0.20	6	425-00

**** with Cup Top**

507. Burettes with Screw Type Rotaflow Stopcock with PTFE key, "LABCO", Accuracy as per Class 'B' of I.S. 1997 : 2008. Routine Quality (Light Wall).

Cat. No.	Capacity ml.	Sub. Div. ml.	Tolerance ± ml.	Min. Qty./Pack	Price/Piece Rs.
507/1	25	0.10	0.10	10	295-00
507/2	50	0.10	0.10	10	330-00
507/3	100	0.20	0.20	10	410-00

508. Burettes with Straight Bore PTFE key Stopcock, "LABCO", Accuracy as per Class 'A' of I.S. 1997 : 2008 with works certificate.

Cat. No.	Capacity ml.	Sub. Div. ml.	Tolerance ± ml.	Min. Qty./Pack	Price/Piece Rs.
508/1	**1	0.01	0.006	2	1200-00
508/2	**2	0.02	0.010	2	1200-00
508/3	**5	0.02	0.010	2	1050-00
508/4	**10	0.05	0.020	2	940-00
508/5	25	0.10	0.050	2	890-00
508/5a	25	0.05	0.030	2	1050-00
508/6	50	0.10	0.050	2	900-00
508/7	100	0.20	0.100	2	925-00

**** with Cup Top**

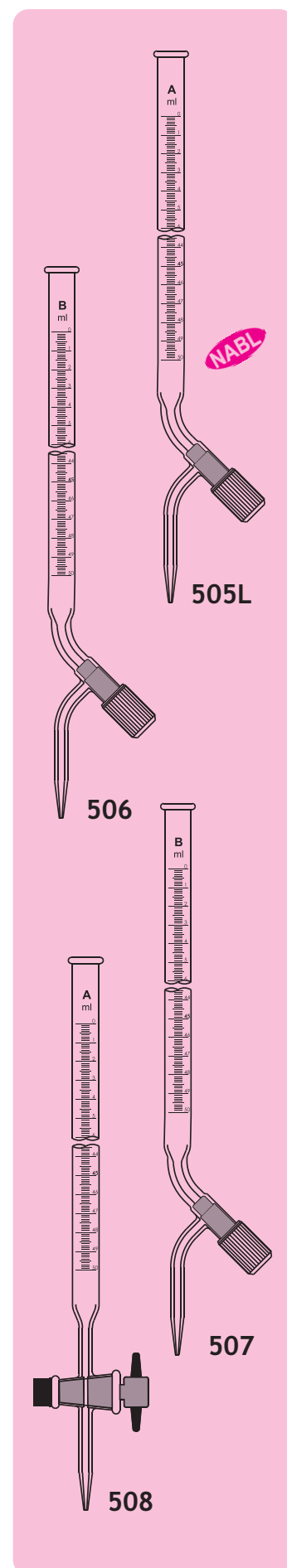

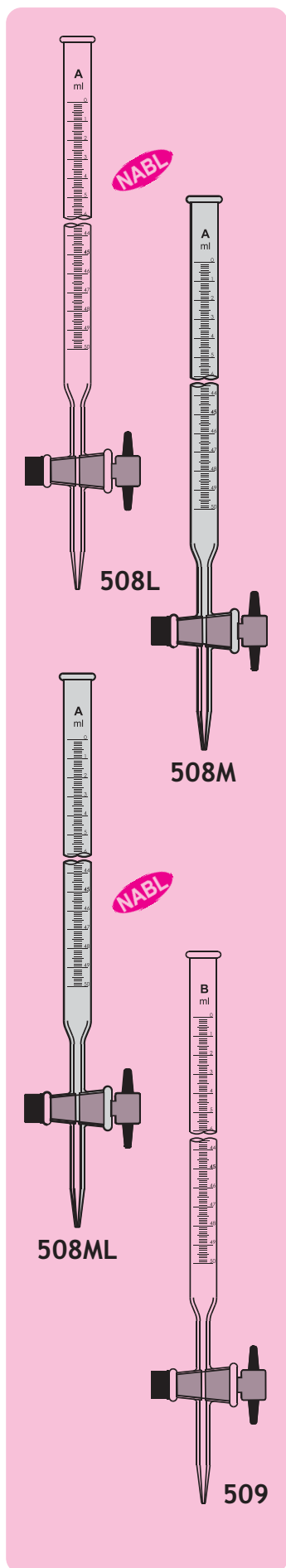

508L. Burettes with Straight Bore PTFE key Stopcock, "LABCO", Accuracy as per Class 'A' of I.S. 1997 : 2008 with NABL certificate.

Cat. No.	Capacity ml.	Sub. Div. ml.	Tolerance \pm ml.	Price/Piece Rs.
508L/1	**1	0.01	0.006	1870-00
508L/2	**2	0.02	0.010	1870-00
508L/3	**5	0.02	0.010	1870-00
508L/4	**10	0.05	0.020	1870-00
508L/5	25	0.10	0.050	1870-00
508L/6	50	0.10	0.050	1870-00
508L/7	100	0.20	0.100	1950-00

**** with Cup Top, + Not Covered in IS.**

508M Amber Colour Burettes, With Straight Bore PTFE Key Stopcock, "LABCO", accuracy as per Class 'A' of I.S. 1997 : 2008

Cat. no.	Cap. ml.	Sub Div ml.	Min. Qty./Pack	Price/Piece Rs.
508M/1	1	0.01	2	1300-00
508M/2	2	0.01	2	1300-00
508M/3	5	0.02	2	1300-00
508M/4	10	0.05	2	1300-00
508M/5	25	0.10	2	1350-00
508M/6	50	0.10	2	1425-00
508M/7	100	0.20	2	1550-00

*** With cup top.**

508ML Amber Colour Burettes, With Straight Bore PTFE Key Stopcock, "LABCO", accuracy as per Class 'A' of I.S. 1997 : 2008 with NABL Certificate.

Cat. no.	Cap. ml.	Sub Div ml.	Tolerance \pm ml.	Min. Qty./Pack	Price/Piece Rs.
508ML/1	1	0.01	0.006	2	1945-00
508ML/2	2	0.02	0.01	2	1945-00
508ML/3	5	0.05	0.01	2	1945-00
508ML/4	10	0.05	0.02	2	1945-00
508ML/5	25	0.10	0.05	2	1945-00
508ML/6	50	0.10	0.05	2	1945-00
508ML/7	100	0.20	0.10	2	2025-00

*** With cup top.**

509. Burettes with Straight Bore PTFE Key Stopcock, "LABCO", Accuracy as per Class 'B' of IS 1997 : 2008.

Cat. No.	Capacity ml.	Sub. Div. ml.	Tolerance \pm ml.	Min. Qty./Pack	Price/Piece Rs.
509/1	**1	0.01	0.01	2	610-00
509/2	**2	0.02	0.02	2	610-00
509/3	**5	0.02	0.02	2	610-00
509/4	**10	0.05	0.05	2	610-00
509/5	25	0.10	0.10	2	575-00
509/6	50	0.10	0.10	2	590-00
509/7	100	0.20	0.20	2	675-00

**** with Cup Top**

510. Burettes, Double Oblique Bore Stopcock, 3-way, "LABCO", Accuracy as per Class 'A' of IS 1997 : 2008, with work certificate.

Cat. No.	Capacity ml.	Sub. Div. ml.	Tolerance \pm ml.	Price/Piece Rs.
510/1	10	0.05	0.02	900-00
510/2	25	0.10	0.05	800-00
510/3	50	0.10	0.05	810-00
510/4	100	0.20	0.10	860-00

511. Burettes, Double Oblique Bore Stopcock, 3-way, "LABCO", Accuracy as per Class 'B' of IS 1997 : 2008.

Cat. No.	Capacity ml.	Sub. Div. ml.	Tolerance \pm ml.	Price/Piece Rs.
511/1	10	0.05	0.05	470-00
511/2	25	0.10	0.10	440-00
511/3	50	0.10	0.10	450-00
511/4	100	0.20	0.20	525-00

512. Burettes, Double Bore Screw type Rotaflow Stopcock with PTFE Keys, "LABCO", Accuracy as per Class 'A' of IS 1997 : 2008, with works certificate.

Cat. No.	Capacity ml.	Sub. Div. ml.	Tolerance \pm ml.	Price/Piece Rs.
512/1	10	0.05	0.02	925-00
512/2	25	0.10	0.05	900-00
512/3	50	0.10	0.05	925-00
512/4	100	0.20	0.10	990-00

513. Burettes, Double Bore Screw type Rotaflow Stopcock with PTFE Keys, "LABCO", Accuracy as per Class 'B' of I.S. 1997 : 2008.

Cat. No.	Capacity ml.	Sub. Div. ml.	Tolerance \pm ml.	Price/Piece Rs.
513/1	10	0.05	0.05	610-00
513/2	25	0.10	0.10	575-00
513/3	50	0.10	0.10	610-00
513/4	100	0.20	0.10	700-00

514. Burettes, Double Oblique Bore PTFE Key Stopcock, 3-way, "LABCO", Accuracy as per Class 'A' of I.S. 1997 : 2008 with works certificates.

Cat. No.	Capacity ml.	Sub. Div. ml.	Tolerance \pm ml.	Price/Piece Rs.
514/1	10	0.05	0.02	1350-00
514/2	25	0.10	0.05	1350-00
514/3	50	0.10	0.05	1375-00
514/4	100	0.20	0.10	1400-00

NOTE : 1 ml., 2 ml. and 5 ml. Burettes to Cat. No. 510 to 514 can also be supplied at the prices of 10 ml. burettes in respective Cat. Nos.

515. Burettes, Over Flow Cup, Automatic Zero, Double Oblique Bore Stopcock, 3-way, Accuracy as per Class 'A' of IS 1997 : 2008 with works certificate, "LABCO".

Cat. No.	Capacity ml.	Sub. Div. ml.	Tolerance \pm ml.	Price/Piece Rs.
515/1	10	0.05	0.02	1150-00
515/2	25	0.10	0.05	1150-00
515/3	50	0.10	0.05	1200-00
515/4	100	0.20	0.10	1275-00

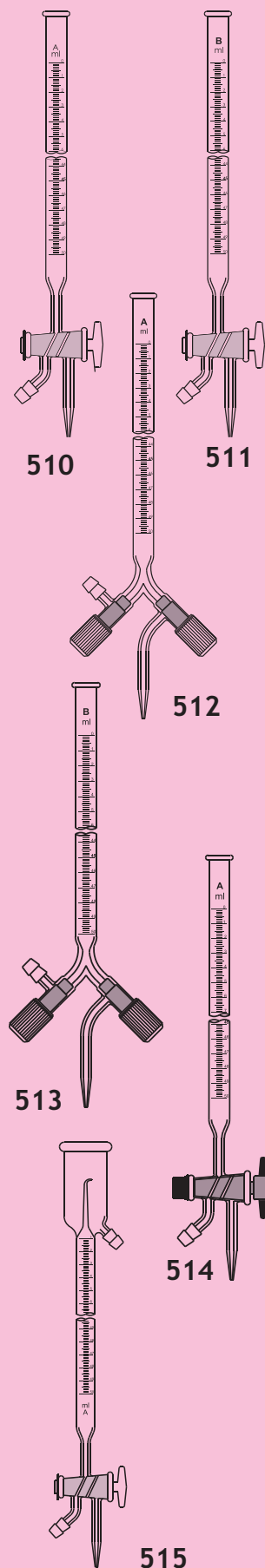

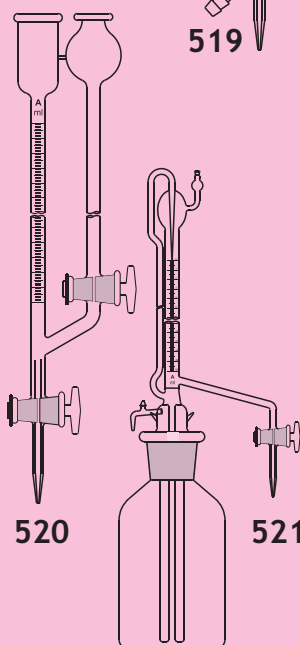
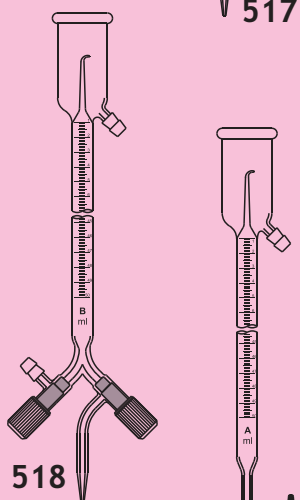
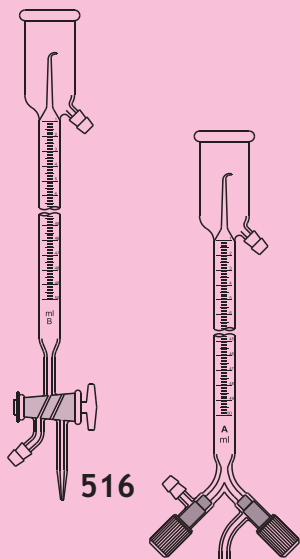

516. Burettes, Over Flow Cup, Automatic Zero, Double Oblique Bore Stopcock, 3-way, Accuracy as per Class 'B' of IS 1997 : 2008, "LABCO".

Cat. No.	Capacity ml.	Sub. Div. ml.	Tolerance \pm ml.	Price/Piece Rs.
516/1	10	0.05	0.05	725-00
516/2	25	0.10	0.10	725-00
516/3	50	0.10	0.10	790-00
516/4	100	0.20	0.20	840-00

517. Burettes, Over Flow Cup, Automatic Zero, Double Bore Screw type Rotaflow Stopcock with PTFE Keys, 3-way, Accuracy as per Class 'A' of IS 1997 : 2008, with works certificate, "LABCO".

Cat. No.	Capacity ml.	Sub. Div. ml.	Tolerance \pm ml.	Price/Piece Rs.
517/1	10	0.05	0.02	1300-00
517/2	25	0.10	0.05	1300-00
517/3	50	0.10	0.05	1325-00
517/4	100	0.20	0.10	1450-00

518. Burettes, Over Flow Cup, Automatic Zero, Double Bore Screw type Rotaflow Stopcock with PTFE Keys, 3-way, Accuracy as per Class 'B' of IS 1997 : 2008, "LABCO".

Cat. No.	Capacity ml.	Sub. Div. ml.	Tolerance \pm ml.	Price/Piece Rs.
518/1	10	0.05	0.05	910-00
518/2	25	0.10	0.10	910-00
518/3	50	0.10	0.10	940-00
518/4	100	0.20	0.20	1000-00

519. Burettes, Over Flow Cup, Automatic Zero, Double Oblique Bore PTFE Key Stopcock, 3-way, Accuracy as per Class 'A' of IS 1997 : 2008, with works certificate, "LABCO".

Cat. No.	Capacity ml.	Sub. Div. ml.	Tolerance \pm ml.	Price/Piece Rs.
519/1	10	0.05	0.02	1950-00
519/2	25	0.10	0.05	1950-00
519/3	50	0.10	0.05	2000-00
519/4	100	0.20	0.10	2050-00

520. Burettes, Micro, Automatic Filling Device with Reservoir, Accuracy as per Class 'A' of IS 1997 : 2008, with works certificate, "LABCO".

Cat. No.	Capacity ml.	Sub. Div. ml.	Tolerance \pm ml.	Price/Piece Rs.
520/1	1	0.01	0.006	1550-00
520/2	2	0.02	0.010	1550-00
520/3	5	0.02	0.010	1550-00
520/4	10	0.05	0.020	1550-00

521. Burettes, Automatic Zero, mounted on Reservoir, Accuracy as per Class 'A' of I.S. 1997 : 2008, with works certificate, "LABCO".

Cat. No.	Capacity ml.	Sub. Div. ml.	Tolerance \pm ml.	Price/Piece Rs.
521/1	10	0.05	0.02	5000-00
521/2	25	0.10	0.05	6000-00
521/2a	25	0.05	0.03	7350-00
521/3	50	0.10	0.05	6300-00
521/4	100	0.20	0.10	6600-00

521L. Burettes, Automatic Zero, "LABCO", mounted on Reservoir, glass key stopcock. Accuracy as per **Class 'A'** of I.S. 1997 : 2008, with **NABL** certificate.

Cat. No.	Capacity ml.	Sub. Div. ml.	Tolerance ± ml.	Price/Piece Rs.
521L/1	10	0.05	0.02	5650-00
521L/2	25	0.10	0.05	6850-00
521L/3	50	0.10	0.05	7000-00
521L/4	100	0.20	0.10	7400-00

521M Amber Colour Burettes, "LABCO", Automatic zero, mounted on Reservoir, glass key stopcock. accuracy as per I.S. 1997 : 2008 with rubber bellow.

Cat. no.	Cap. ml.	Sub Div ml.	Min. Qty./Pack	Price/Piece Rs.
521M/1	10	0.05	1	7000-00
521M/2	25	0.10	1	7400-00
521M/3	50	0.10	1	8475-00
521M/4	100	0.20	1	8800-00

Note : Reservoir Capacity 500 ml. for 10 ml. burette and 2000 ml. for 25,50 and 100 ml. burettes.

521ML Amber Colour Burettes, "LABCO", Automatic zero, with glass key Stopcock, mounted on Reservoir, with accuracy as per I.S. 1997 : 2008 **Class 'A'** with **NABL** Certificate.

Cat. no.	Cap. ml.	Sub Div ml.	Min. Qty./Pack	Price/Piece Rs.
521ML/1	10	0.05	1	7700-00
521ML/2	25	0.10	1	8050-00
521ML/3	50	0.10	1	9100-00
521ML/4	100	0.20	1	9550-00

522. Burettes, Automatic Zero, mounted on Reservoir, Accuracy as per **Class 'B'** of IS 1997 : 2008, **"LABCO"**.

Cat. No.	Capacity ml.	Sub. Div. ml.	Tolerance ± ml.	Price/Piece Rs.
522/1	10	0.05	0.05	4300-00
522/2	25	0.10	0.10	5000-00
522/3	50	0.10	0.10	5200-00
522/4	100	0.20	0.20	5600-00

523. Burettes, Automatic Zero, mounted on Reservoir, with screw type Rotaflow Stopcock with PTFE Key, Accuracy as per **Class 'A'** of IS 1997 : 2008, with works certificate, **"LABCO"**.

Cat. No.	Capacity ml.	Sub. Div. ml.	Tolerance ± ml.	Price/Piece Rs.
523/1	10	0.05	0.02	5000-00
523/2	25	0.10	0.05	6000-00
523/3	50	0.10	0.05	6300-00
523/4	100	0.20	0.10	6600-00

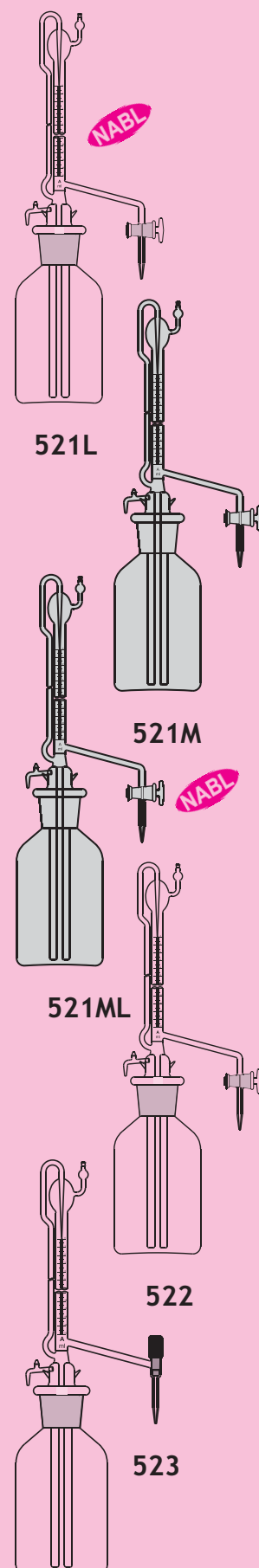

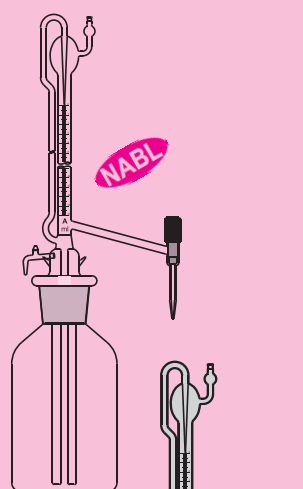

523L

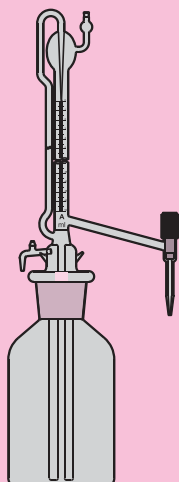

523M

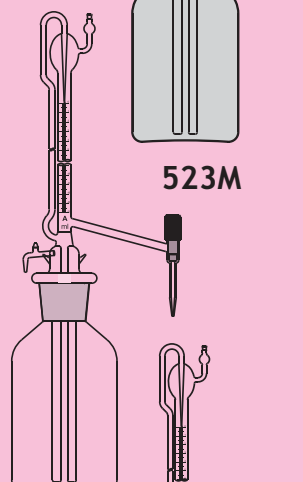

524

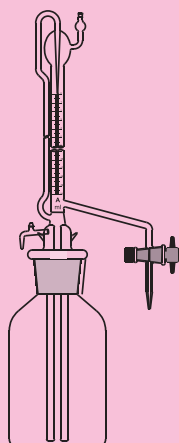

525

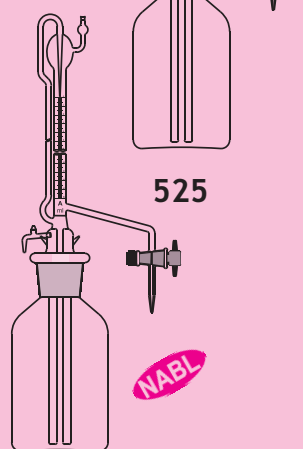

525L

523L. Burettes, Automatic Zero, "LABCO", mounted on Reservoir, with screw type PTFE Needle Valve Stopcock, Accuracy as per **Class 'A'** of I.S. 1997 : 2008, with **NABL** certificate.

Cat. No.	Capacity ml.	Sub. Div. ml.	Tolerance ± ml.	Price/Piece Rs.
523L/1	10	0.05	0.02	5650-00
523L/2	25	0.10	0.05	6850-00
523L/3	50	0.10	0.05	7000-00
523L/4	100	0.20	0.10	7400-00

523M Amber Colour Burettes, "LABCO", Automatic Zero, Screw Type PTFE needle valve stopcock mounted on reservoir, accuracy as per **Class 'A'** of I.S. 1997:2008, ISO 385:2005 with work certificate.

Cat. No.	Capacity ml.	Sub. Div. ml.	Tolerance ± ml.	Price/Piece Rs.
523M/1	10	0.05	0.02	7000-00
523M/2	25	0.10	0.05	7400-00
523M/3	50	0.10	0.05	8500-00
523M/4	100	0.20	0.10	8800-00

524. Burettes, Automatic Zero, mounted on Reservoir, with screw type Rotaflow Stopcock with PTFE Key, Accuracy as per **Class 'B'** of IS 1997 : 2008, with works certificate, **"LABCO"**.

Cat. No.	Capacity ml.	Sub. Div. ml.	Tolerance ± ml.	Price/Piece Rs.
524/1	10	0.05	0.05	4300-00
524/2	25	0.10	0.10	5000-00
524/3	50	0.10	0.10	5200-00
524/4	100	0.20	0.20	5600-00

525. Burettes, Automatic Zero, mounted on Reservoir, with PTFE Key Stopcock, Accuracy as per **Class 'A'** of I.S. 1997 : 2008, with works certificate, **"LABCO"**.

Cat. No.	Capacity ml.	Sub. Div. ml.	Tolerance ± ml.	Price/Piece Rs.
525/1	10	0.05	0.02	5400-00
525/2	25	0.10	0.05	6400-00
525/3	50	0.10	0.05	6600-00
525/4	100	0.20	0.10	6900-00

525L. Burettes, Automatic Zero, "LABCO", mounted on Reservoir, with PTFE Key Stopcock, Rubber Bellow. Accuracy as per **Class 'A'** of I.S. 1997 : 2008, with **NABL** certificate..

Cat. No.	Capacity ml.	Sub. Div. ml.	Tolerance ± ml.	Price/Piece Rs.
525L/1	10	0.05	0.02	6100-00
525L/2	25	0.10	0.05	7000-00
525L/3	50	0.10	0.05	7200-00
525L/4	100	0.20	0.10	7600-00

525M Amber Colour Burettes, "LABCO", Automatic Zero, with PTFE Key stopcock mounted on reservoir, accuracy as per I.S. 1997:2008, ISO 385:2005, Class 'A'.

Cat. No.	Capacity ml.	Sub. Div. ml.	Tolerance ± ml.	Price/Piece Rs.
525M/1	10	0.05	0.02	7250-00
525M/2	25	0.10	0.05	7800-00
525M/3	50	0.10	0.05	8850-00
525M/4	100	0.20	0.10	9200-00

525ML Amber Colour Burettes Automatic Zero, with PTFE Key stopcock, "LABCO", mounted on reservoir, accuracy as per Class 'A' of I.S. 1997:2008 with NABL works certificate

Cat. No.	Capacity ml.	Sub. Div. ml.	Tolerance ± ml.	Price/Piece Rs.
525ML/1	10	0.05	0.02	8000-00
525ML/2	25	0.10	0.05	8450-00
525ML/3	50	0.10	0.05	9300-00
525ML/4	100	0.20	0.10	9850-00

526 Burette Automatic For K.F. Apparatus - With Automatic zero device at top & syphon type return for overflow, complete with Calcium Chloride tube & Amber Coloured reservoir of Capacity 500 ml. Provided with two high vacuum PTFE leakproof stopcocks Class 'A' with works certificate.

Cat. No.	Cap. ml	Sub Div. ml	Tolerance ± ml	Teflon Key
526/1	10	0.05	0.02	5800-00
526/2	25	0.05	0.02	6800-00

527 Rubber Bellow with cotton net for Automatic Burettes 385-00

528 Burette Cleaning Brush 30" long, Nylon (Pack of 10pcs) 675-00

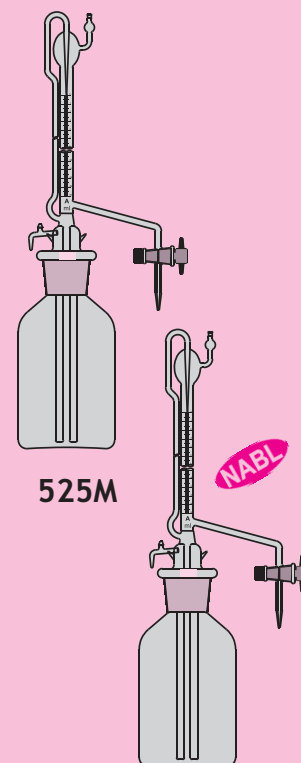

525M

NABL

525ML

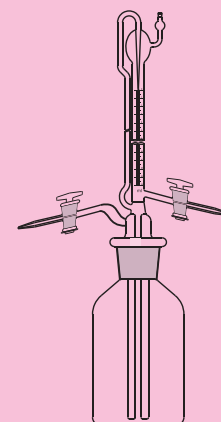

526



527



528

PIPETTES

540. Pipettes Transfer Volumetric, "LABCO", with one mark, Accuracy as per Class 'A' of I.S. 1117 : 1975 with works certificate, Supplied with colour code.

Cat. No.	Capacity ml.	Tolerance ± ml.	Min. Qty./Pack	Price/Piece Rs.
540/1	1	0.006	6	180-00
540/2	2	0.010	6	180-00
540/3	3	0.010	6	180-00
540/4	4	0.010	6	180-00
540/5	5	0.015	6	185-00
540/6	10	0.020	6	185-00
540/7	15	0.030	6	225-00
540/8	20	0.030	6	225-00
540/9	25	0.030	6	230-00
540/10	50	0.050	4	300-00
540/11	100	0.080	4	425-00

540L. Pipettes Transfer Volumetric, "LABCO", with one mark, Accuracy as per Class 'A' of I.S. 1117 : 1975 with NABL certificate.

Cat. No.	Capacity ml.	Tolerance ± ml.	Min. Qty./Pack	Price/Piece Rs.
540L/1	1	0.006	10	450-00
540L/2	2	0.010	10	450-00
540L/3	3	0.010	10	450-00
540L/4	4	0.010	10	450-00
540L/5	5	0.015	10	450-00
540L/6	6	0.015	10	450-00
540L/7	7	0.015	10	450-00
540L/8	8	0.020	10	450-00
540L/9	9	0.020	10	450-00
540L/10	10	0.020	10	450-00
540L/11	15	0.030	10	450-00
540L/12	20	0.030	10	475-00
540L/13	25	0.030	10	475-00
540L/14	50	0.050	10	500-00
540L/15	100	0.080	10	550-00

540M Amber Coloured Pipettes Transfer Volumetric, "LABCO", with one mark, Accuracy as per Class 'A' of I.S. 1117 : 1975.

Cat. No.	Capacity ml.	Tolerance ± ml.	Min. Qty./Pack	Price/Piece Rs.
540M/1	1	0.006	5	225-00
540M/2	2	0.01	5	225-00
540M/3	5	0.015	5	225-00
540M/4	10	0.02	5	250-00
540M/5	20	0.03	5	280-00
540M/6	25	0.05	5	280-00
540M/7	50	0.05	5	390-00
540M/8	100	0.08	5	485-00

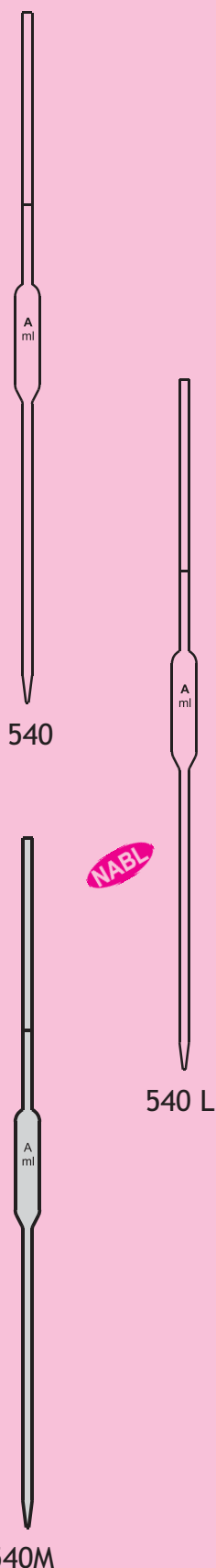

540ML Amber Coloured Pipettes Transfer Volumetric, "LABCO", with one mark, Accuracy as per Class 'A' of I.S. 1117:1975, with NABL works certificate

Cat No.	Capacity ml.	Tolerance ±	Min. Qty./Pack	Price/Piece Rs.
540ML/1	1	0.006	2	555-00
540ML/2	2	0.010	2	555-00
540ML/3	5	0.015	2	555-00
540ML/4	10	0.02	2	560-00
540ML/5	20	0.03	2	600-00
540ML/6	25	0.05	2	600-00
540ML/7	50	0.05	2	660-00
540ML/8	100	0.08	2	710-00

540a. Pipettes Transfer Volumetric, "LABCO", with one mark, Accuracy as per Class 'A' USP (US Pharmacopeia) with Certificate.

Cat. No.	Capacity ml.	Tolerance ± ml.	Min. Qty./Pack	Price/Piece Rs.
540a/1	1	0.006	6	190.00
540a/2	2	0.006	6	190.00
540a/3	3	0.01	6	190.00
540a/4	4	0.01	6	190.00
540a/5	5	0.01	6	195.00
540a/6	6	0.01	6	200.00
540a/7	7	0.01	6	200.00
540a/8	8	0.02	6	210.00
540a/9	9	0.02	6	210.00
540a/10	10	0.02	6	215.00
540a/11	15	0.03	6	215.00
540a/12	20	0.03	6	260.00
540a/13	25	0.03	6	265.00
540a/14	30	0.03	6	270.00
540a/15	40	0.05	6	350.00
540a/16	50	0.05	6	375.00
540a/17	100	0.08	6	470.00

541. Pipettes Transfer, "LABCO", Volumetric, with one mark, Medium wall. Accuracy as per Class 'B' of I.S. 1117 : 1975.

Cat. No.	Capacity ml.	Tolerance ± ml.	Min. Qty./Pack	Price/Piece Rs.
541/1	1	0.015	6	110-00
541/2	2	0.020	6	110-00
541/3	3	0.020	6	110-00
541/4	4	0.020	6	110-00
541/5	5	0.030	6	110-00
541/6	10	0.040	6	115-00
541/7	15	0.040	6	125-00
541/8	20	0.060	6	130-00
541/9	25	0.060	6	130-00
541/10	50	0.100	4	185-00
541/11	100	1.160	4	240-00

Note :For Safety Bulb for Cat. No.540, 541 & 542 Rs. 2.00 extra.

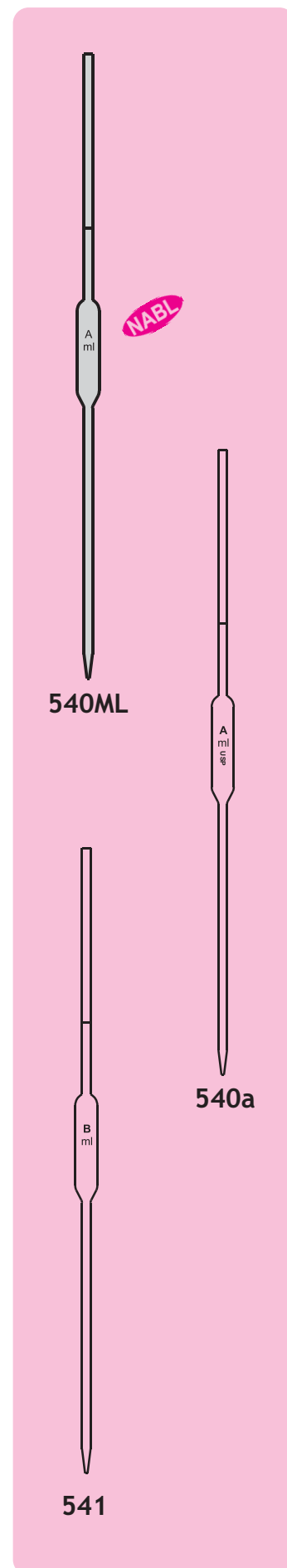

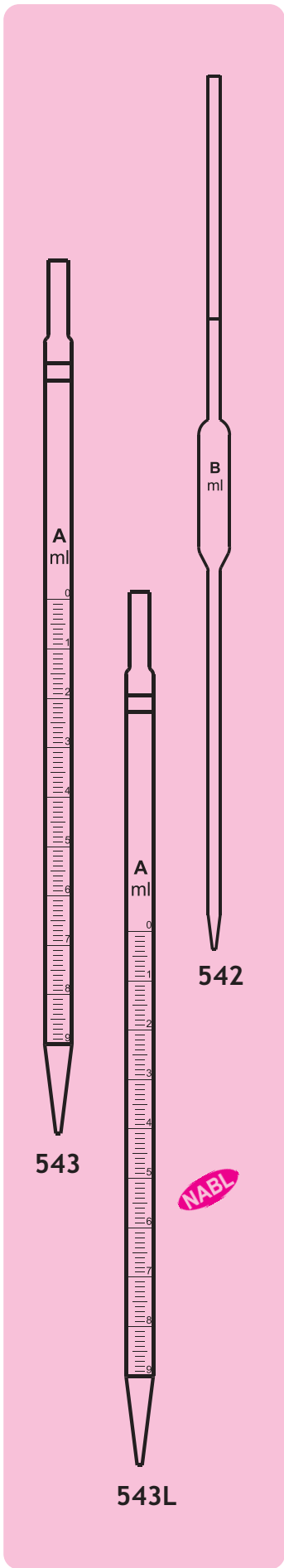

542. Pipettes Transfer, "LABCO", Volumetric, with one mark, Light wall. Accuracy as per Class 'B' of I.S. 1117 : 1975.

Cat. No.	Capacity ml.	Tolerance ± ml.	Min. Qty./Pack	Price/Piece Rs.
542/1	1	0.015	10	84-00
542/2	2	0.020	10	88-00
542/3	5	0.030	10	93-00
542/4	10	0.040	10	95-00
542/5	20	0.060	10	110-00
542/6	25	0.060	10	115-00
542/7	50	0.100	6	160-00
542/8	100	1.160	6	225-00

543. Pipettes, Measuring, Graduated, Serological, "LABCO", Accuracy as per Class 'A' of I.S / ISO 835 : 2007 with works certificate. (These pipettes are graduated to tip and calibrated to deliver their total capacity when the last drop is blown out) Colour coded.

Cat. No.	Capacity ml.	Sub. Div. ml.	Tolerance ± ml.	Min. Qty./Pack	Price/Piece Rs.
543/1	0.1	0.01	0.006	6	220-00
543/2	0.2	0.01	0.006	6	220-00
543/3	0.5	0.02	0.006	6	220-00
543/4	1.0	0.01	0.006	6	220-00
543/5	1.0	0.10	0.006	6	220-00
543/6	2.0	0.02	0.010	6	220-00
543/7	2.0	0.10	0.010	6	220-00
543/8	5.0	0.05	0.030	6	220-00
543/9	5.0	0.10	0.050	6	220-00
543/10	10.0	0.10	0.050	6	220-00
543/11	25.0	0.20	0.100	6	310-00

543L. Pipettes, Measuring, Graduated, Serological, "LABCO", Accuracy as per Class 'A' of I.S / ISO 835 : 2007 with NABL certificate. (These pipettes are graduated to deliver from any Graduation line down to zero at the jet, with last drop expelled by blowing) Colour coded.

Cat. No.	Capacity ml.	Sub. Div. ml.	Tolerance ± ml.	Price/Piece Rs.
543L/1	1.0	0.01	0.006	500-00
543L/2	1.0	0.10	0.006	500-00
543L/3	2.0	0.02	0.010	500-00
543L/4	2.0	0.10	0.010	500-00
543L/5	5.0	0.05	0.030	500-00
543L/6	5.0	0.10	0.050	500-00
543L/7	10.0	0.10	0.050	500-00
543L/8	25.0	0.20	0.100	530-00

543M Amber Coloured Pipettes, Measuring, Graduated, Serological, "LABCO", Accuracy as per **Class 'A'** of I.S / ISO 835 : 2007.

Cat. No.	Capacity ml.	Sub Div ml.	Min. Qty./Pack	Price/Piece Rs.
543M/1	0.1	0.01	2	300-00
543M/2	0.2	0.01	2	300-00
543M/3	0.5	0.02	2	300-00
543M/4	1.0	0.01	2	300-00
543M/5	1.0	0.10	2	300-00
543M/6	2.0	0.02	2	300-00
543M/7	2.0	0.10	2	300-00
543M/8	5.0	0.10	2	300-00
543M/9	5.0	0.05	2	300-00
543M/10	10.0	0.10	2	300-00
543M/11	25.0	0.20	2	350-00

543ML Amber Coloured Pipettes, Measuring, Graduated, Serological, "LABCO", Accuracy as per **Class 'A'** with **NABL** certificate. of I.S / ISO 835 : 2007.

Cat. No.	Capacity ml. ml.	Sub Div Rs.	Price/Piece
543ML/1	1.0	0.01	580-00
543ML/2	1.0	0.10	580-00
543ML/3	2.0	0.02	580-00
543ML/4	2.0	0.10	580-00
543ML/5	5.0	0.10	580-00
543ML/6	5.0	0.05	580-00
543ML/7	10.0	0.10	580-00
543ML/8	25.0	0.20	600-00

544. Pipettes, Measuring, Graduated, Serological, "LABCO", Accuracy as per **Class 'B'** (These pipettes are graduated to tip and calibrated to deliver their total capacity when the last drop is blown out.) **Colour coded.**

Cat. No.	Capacity ml.	Sub. Div. ml.	Tolerance ± ml.	Min. Qty./Pack	Price/Piece Rs.
544/1	0.1	0.01	0.01	12	130-00
544/2	0.2	0.01	0.01	12	130-00
544/3	0.5	0.02	0.01	12	130-00
544/4	1.0	0.01	0.01	12	130-00
544/5	1.0	0.10	0.01	12	130-00
544/6	2.0	0.02	0.02	12	130-00
544/7	2.0	0.10	0.02	12	130-00
544/8	5.0	0.05	0.05	12	130-00
544/9	5.0	0.10	0.10	12	130-00
544/10	10.0	0.10	0.10	12	130-00
544/11	25.0	0.20	0.20	12	150-00

545. Pipettes, Measuring, Graduated, Mohr type, "LABCO", Accuracy as per **Class 'A'** of I.S. /ISO 835:2007 with works certificate. (These pipettes are graduated for the delivery from zero mark to the graduation mark.) **Colour coded.**

Cat. No.	Capacity ml.	Sub. Div. ml.	Tolerance ± ml.	Min. Qty./Pack	Price/Piece Rs.
545/1	0.1	0.01	0.006	6	220-00
545/2	0.2	0.01	0.006	6	220-00
545/3	0.5	0.02	0.006	6	220-00
545/4	1.0	0.01	0.006	6	220-00
545/5	1.0	0.10	0.006	6	220-00
545/6	2.0	0.02	0.010	6	220-00
545/7	2.0	0.10	0.010	6	220-00
545/8	5.0	0.05	0.030	6	220-00
545/9	5.0	0.10	0.030	6	220-00
545/10	10.0	0.10	0.050	6	220-00
545/11	25.0	0.20	0.100	6	310-00

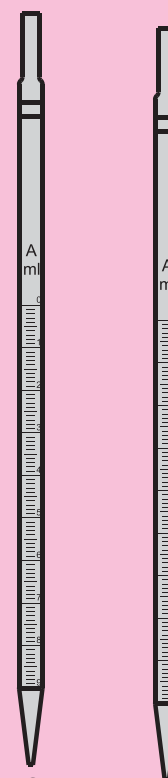

543M

543ML

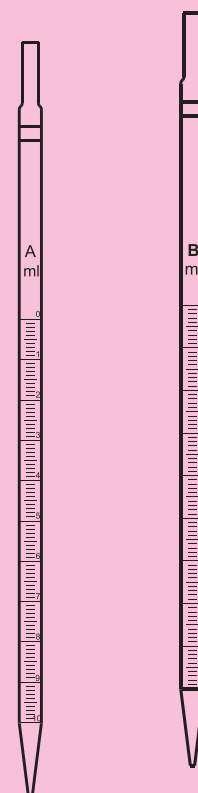

545

544

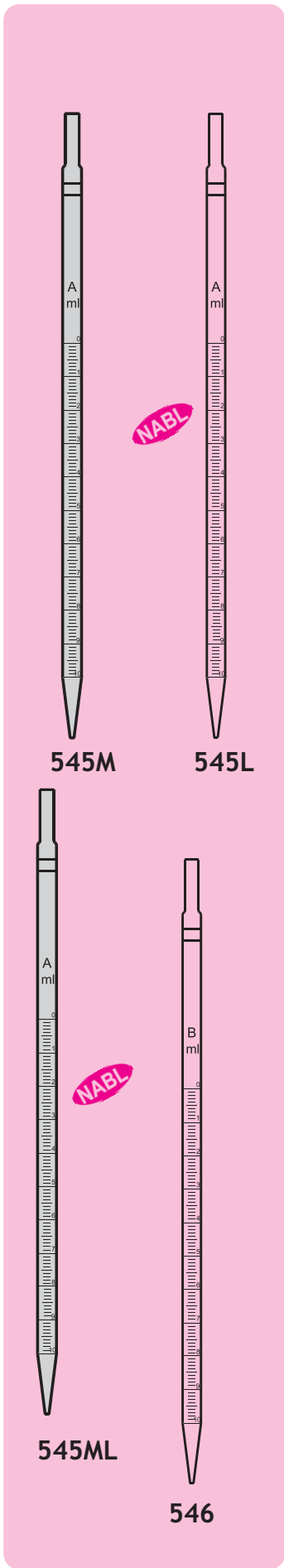

545L. Pipettes, Measuring, Graduated, Mohr type, "LABCO", Accuracy as per **Class 'A'** of I.S. / ISO 835:2007 with **NABL** certificate. (These pipettes are calibrated to the delivery from zero at top to graduation mark.) **Colour coded.**

Cat. No.	Capacity ml.	Sub. Div. ml.	Tolerance \pm ml.	Price/Piece Rs.
545L/1	0.1	0.01	0.006	500-00
545L/2	0.2	0.01	0.006	500-00
545L/3	0.5	0.02	0.006	500-00
545L/4	1.0	0.01	0.006	500-00
545L/5	1.0	0.10	0.006	500-00
545L/6	2.0	0.02	0.010	500-00
545L/7	2.0	0.10	0.010	500-00
545L/8	5.0	0.05	0.030	500-00
545L/9	5.0	0.10	0.030	500-00
545L/10	10.0	0.10	0.050	500-00
545L/11	25.0	0.20	0.100	530-00

545M Amber Colour Pipettes, Graduated, Mohr's type "LABCO", accuracy as per **Class 'A'** of I.S. / ISO 835:2007.

Cat. No.	Capacity ml.	Sub Div ml.	Min. Qty./Pack	Price/Piece Rs.
545M/1	0.1	0.01	2	300-00
545M/2	0.2	0.01	2	300-00
545M/3	0.5	0.02	2	300-00
545M/4	1.0	0.01	2	300-00
545M/5	1.0	0.10	2	300-00
545M/6	2.0	0.02	2	300-00
545M/7	2.0	0.10	2	300-00
545M/8	5.0	0.10	2	300-00
545M/9	5.0	0.05	2	300-00
545M/10	10.0	0.10	2	300-00
545M/11	25.0	0.20	2	350-00

545ML Amber Colour Pipettes, Measuring Graduated, Mohr's type, "LABCO", accuracy as per **Class 'A'** of I.S. / ISO 835 : 2007 with **NABL** works Certificate.

Cat. No.	Capacity ml. ml.	Sub Div Rs.	Price/Piece
545ML/1	1.0	0.01	580-00
545ML/2	1.0	0.10	580-00
545ML/3	2.0	0.02	580-00
545ML/4	2.0	0.10	580-00
545ML/5	5.0	0.10	580-00
545ML/6	5.0	0.05	580-00
545ML/7	10.0	0.10	580-00
545ML/8	25.0	0.20	600-00

546. Pipettes, Measuring, Graduated, Mohr type, "LABCO", Accuracy as per **Class 'B'** of I.S. 4162 : 1985. (These pipettes are graduated for delivery from zero mark to the graduation mark.) **Colour coded.**

Cat. No.	Capacity ml.	Sub. Div. ml.	Tolerance \pm ml.	Min. Qty./Pack	Price/Piece Rs.
546/1	0.1	0.01	0.01	12	130-00
546/2	0.2	0.01	0.01	12	130-00
546/3	0.5	0.02	0.01	12	130-00
546/4	1.0	0.01	0.01	12	130-00
546/5	1.0	0.10	0.01	12	130-00
546/6	2.0	0.02	0.02	12	130-00
546/7	2.0	0.10	0.02	12	130-00
546/8	5.0	0.05	0.05	12	130-00
546/9	5.0	0.10	0.10	12	130-00
546/10	10.0	0.10	0.10	12	130-00
546/11	25.0	0.20	0.20	12	150-00

549. Automatic Pipettes, "LABCO", with Overflow Cup. Class 'A' with works certificate.

Cat. No.	Capacity ml. ± ml.	Tolerance Rs.	Price/Piece
549/1	5	0.06	650-00
549/2	10	0.08	650-00
549/3	20	0.10	700-00
549/4	25	0.12	700-00
549/5	50	0.15	750-00
549/6	100	0.25	750-00

551. Pipettes Automatic "LABCO", Quick acting for rapid work of approximate accuracy (Tilt Measure) Complete with Conical Flask and interchangeable joint.

Cat. No.	Capacity ml. ml.	Reservoir Cap. Rs.	Price/Piece
551/1	1	100	560-00
551/2	2	100	560-00
551/3	5	250	600-00
551/4	10	250	600-00
551/5	20	500	630-00
551/6	25	500	630-00

552. Pipettes for Milk Testing "LABCO", 10.75 ml. as per I.S. Specification No. 1223 (Part II) : 1972. 110-00

553. -do- Class A with works certificate, "LABCO". 158-00

553L -do- Class A with NABL works certificate, "LABCO" 460-00

554. Pipette for Milk Test "LABCO", Bacteriological Graduated as per I.S. Specifications No. 2025 : 1962.

Cat. No.	Capacity ml.	Marked at ml.	Tolerance ± ml.	Price/Piece Rs.
554/1	1.1	0.5, 1 & 1.1	0.025	145-00
554/2	2.2	1.0, 2.0, 2.1 & 2.2	0.040	155-00

555. Pipette Alcohol, "LABCO", 1 ml., one mark. 54-00

556. Pipette E.S.R. "LABCO", 200 mm. graduation, 300 mm long. 70-00

560. Pipette, Artificial Insemination, Cattle, Taper Tip. Neutral Hard Glass, 450mm. long. 68-00

561. Pipette, Pasteur, Borosilicate Glass w/o teat
Length 145 mm. 14-00
Length 230 mm. 16-00

562 Silicon Pipette Filler (Bulb)

Cat. No.	Size ml.	Capacity ± ml.	Minimum Qty / Pack	Price/Piece Rs.
562/1	Small	5	5	34-00
562/2	Medium	10	5	44-00
562/3	Large	15	5	50-00
562/4	X. Large	20	5	69-00
562/5	Oval Shape	25	5	160-00
562/6	XX. Large	50	5	320-00
562/7	XXX. Large	100	5	440-00

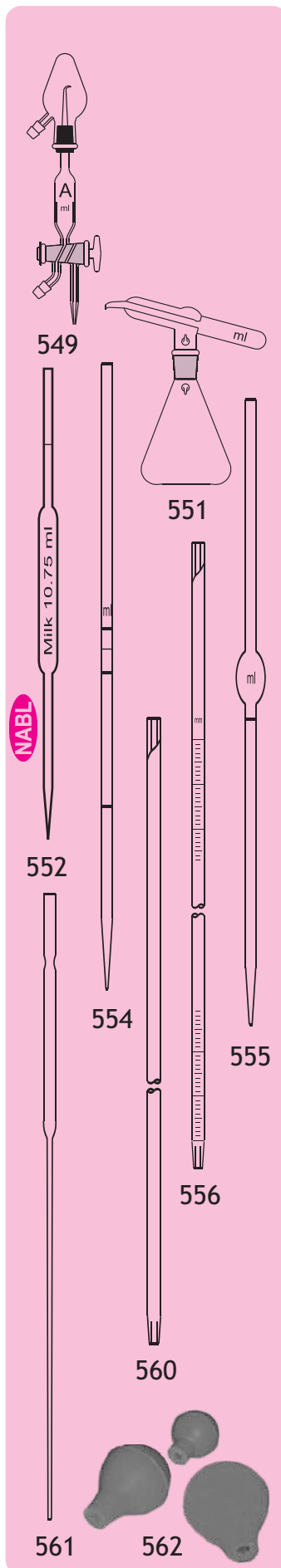

MEASURING / VOLUMETRIC FLASKS

580. Flask Volumetric (Measuring) "LABCO", with interchangeable stopper, accuracy as per Class 'A' of I.S. 915 : 2012, with works certificate.

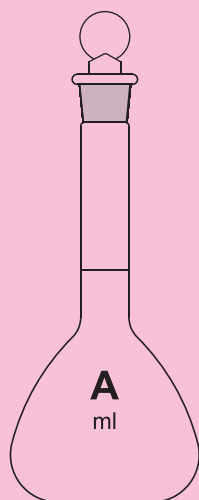

580

Cat. No.	Capacity ml.	Tolerance ± ml.	Stopper Size	Min. Qty./Pack	Price/Piece Rs.
580/1	*1	0.010	10/15	2	400-00
580/2	*2	0.015	10/15	2	400-00
580/3	5	0.025	10/15	2	380-00
580/4	10	0.025	10/15	2	385-00
580/5	15	0.025	10/15	2	385-00
580/5a	20	0.040	10/15	2	345-00
580/6	25	0.040	10/15	2	345-00
580/7	30	0.040	10/15	2	345-00
580/8	50	0.060	10/15	2	350-00
580/9	75	0.060	14/15	2	360-00
580/10	100	0.100	14/15	2	365-00
580/11	150	0.100	14/15	2	490-00
580/12	200	0.150	14/15	2	490-00
580/13	250	0.150	14/15	2	490-00
580/14	300	0.150	14/15	2	640-00
580/15	500	0.250	19/20	2	800-00
580/16	1000	0.400	19/20	2	1175-00
580/17	1500	0.600	24/25	2	1850-00
580/18	2000	0.600	24/25	2	2100-00
580/19	5000	1.200	34/35	1	11000-00

* 1 ml. and 2 ml. Volumetric Flasks are of Test Tube shape.

- 580L. Flask Volumetric (Measuring) "LABCO", with interchangeable stopper, accuracy as per Class 'A' of I.S. 915 : 2012 with NABL certificate.

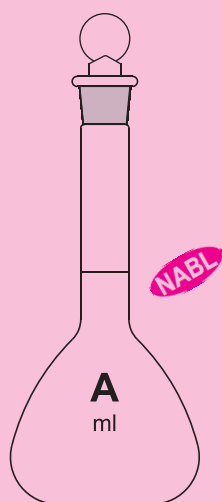

580L

Cat. No.	Capacity ml.	Tolerance ± ml.	Stopper Size	Price/Piece Rs.
580L/1	*1	0.010	10/15	615-00
580L/2	*2	0.015	10/15	615-00
580L/3	5	0.025	10/15	620-00
580L/4	10	0.025	10/15	630-00
580L/5	20	0.040	10/15	600-00
580L/5a	25	0.040	10/15	580-00
580L/6	50	0.060	10/15	550-00
580L/7	100	0.100	14/15	540-00
580L/8	200	0.150	14/15	760-00
580L/9	250	0.150	14/15	760-00
580L/10	500	0.250	19/20	1000-00
580L/11	1000	0.400	19/20	1475-00
580L/12	2000	0.600	24/25	2375-00

*1 ml. and 2 ml. Volumetric Flasks are of Test Tube shape.

580M Amber Colour Flasks Volumetric, "LABCO", With interchangeable stopper, accuracy as per I.S. 915 : 2012 **Class 'A'**

Cat. No.	Capacity ml.	Tolerance \pm ml	Stopper Size	Minimum Qty./Pack	Price/Piece Rs.
580M/1	*1	0.010	10/15	2	470-00
580M/2	*2	0.015	10/15	2	470-00
580M/3	5	0.025	10/15	2	475-00
580M/4	10	0.025	10/15	2	480-00
580M/5	15	0.025	10/15	2	490-00
580M/5a	20	0.040	10/15	2	460-00
580M/6	25	0.040	10/15	2	470-00
580M/7	30	0.040	10/15	2	525-00
580M/8	50	0.060	10/15	2	455-00
580M/9	75	0.060	14/15	2	500-00
580M/10	100	0.100	14/15	2	485-00
580M/11	150	0.100	14/15	2	535-00
580M/12	200	0.150	14/15	2	630-00
580M/13	250	0.150	14/15	2	630-00
580M/14	300	0.150	14/15	2	640-00
580M/15	500	0.250	19/20	2	980-00
580M/16	1000	0.400	19/20	2	1450-00
580M/17	1500	0.600	24/25	2	2950-00
580M/18	2000	0.600	24/25	2	2700-00
580M/19	5000	1.200	34/35	1	15700-00

* 1 ml and 2 ml sizes are of Test Tube shape.

580ML Amber Colour Flask Volumetric (Measuring) "LABCO", With interchangeable Glass stopper, accuracy as per **Class 'A'** of I.S. 915 : 2012, with **NABL** works certificate.

Cat. No.	Capacity ml.	Tolerance \pm ml	Stopper Size	Minimum Qty./Pack	Price/Piece Rs.
580ML/1	1	0.025	10/15	2	645-00
580ML/2	2	0.025	10/15	2	645-00
580ML/3	5	0.025	10/15	2	645-00
580ML/4	10	0.025	10/15	2	645-00
580ML/5	20	0.04	10/15	2	675-00
580ML/5a	25	0.04	10/15	2	675-00
580ML/6	50	0.06	10/15	2	725-00
580ML/7	100	0.10	14/15	2	800-00
580ML/8	200	0.15	14/15	2	945-00
580ML/9	250	0.15	14/15	2	945-00
580ML/10	500	0.25	19/20	2	1400-00
580ML/11	1000	0.40	19/20	2	1925-00
580ML/12	2000	0.60	24/25	2	3400-00

* 1 ml and 2 ml sizes are of Test Tube shape.

580U Flask Volumetric (Measuring) "LABCO", interchangeable stopper. Accuracy tolerance as per **USP standard. Class 'A'** with works certificate

Cat. No.	Capacity ml.	Tolerance \pm ml.	Stopper Size	Min. Qty./Pack	Price/Piece Rs.
580U/3	5	0.02	10/15	2	475-00
580U/4	10	0.02	10/15	2	485-00
580U/5	20	0.03	10/15	2	385-00
580U/5a	25	0.03	10/15	2	385-00
580U/6	50	0.05	10/15	2	385-00
580U/7	100	0.08	14/15	2	400-00
580U/8	200	0.12	14/15	2	540-00
580U/9	250	0.12	14/15	2	545-00
580U/10	500	0.15	19/20	2	875-00
580U/11	1000	0.30	19/20	2	1200-00
580U/12	2000	0.50	24/25	2	2300-00

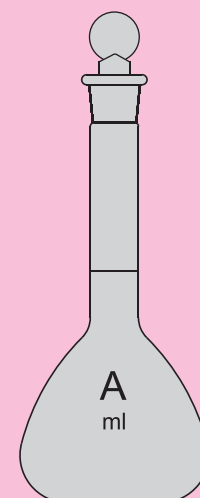

580M

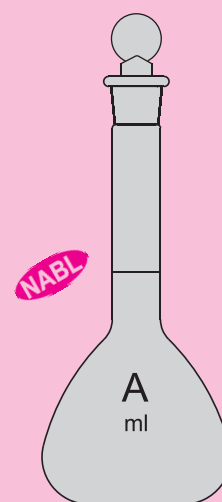

580ML

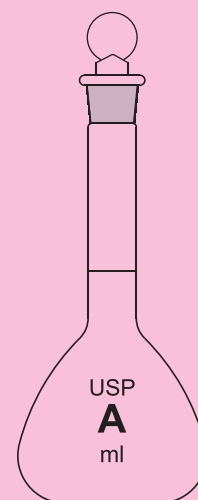

580U

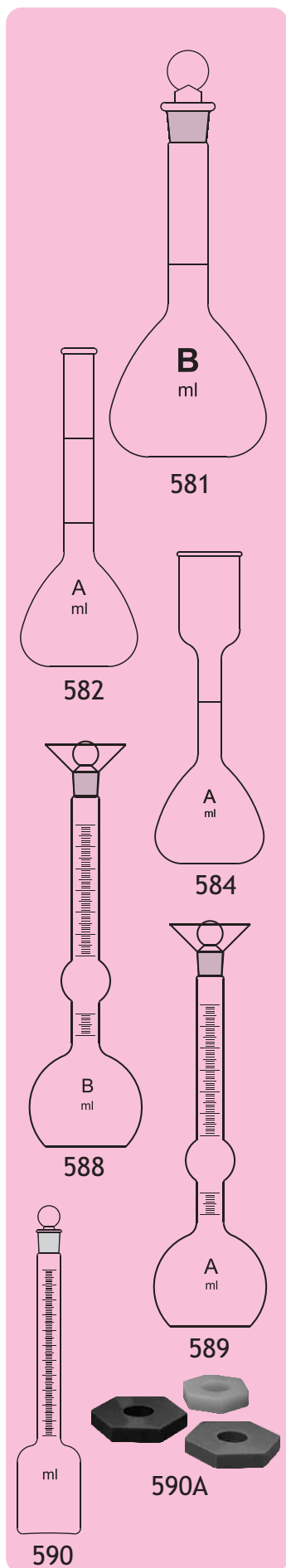

581. Flask Volumetric (Measuring) "LABCO", with interchangeable stopper, accuracy as per Class 'B' of I.S. 915 : 2012

Cat. No.	Capacity ml.	Tolerance \pm ml.	Stopper Size	Min. Qty./Pack	Price/Piece Rs.
581/1	*1	0.02	10/15	2	145-00
581/2	*2	0.03	10/15	2	145-00
581/3	5	0.05	10/15	2	155-00
581/4	10	0.05	10/15	2	160-00
581/5	20	0.05	10/15	2	150-00
581/5a	25	0.08	10/15	2	150-00
581/6	50	0.12	10/15	2	180-00
581/7	100	0.20	14/15	2	210-00
581/8	200	0.30	14/15	2	240-00
581/9	250	0.30	14/15	2	240-00
581/10	500	0.50	19/20	2	380-00
581/11	1000	0.60	19/20	2	600-00
581/12	2000	1.20	24/25	2	1150-00

*** 1 ml. and 2 ml. Volumetric Flasks are of Test Tubeshape.**

582. Flasks Volumetric "LABCO", Sugar estimation with two marks without stopper,

Cat. No.	Capacity Circle marked at ml.	Class 'A' Rs/Piece	Class 'B' Rs/Piece
582/1	50 & 55	320-00	180-00
582/2	100 & 110	360-00	250-00
582/3	200 & 220	440-00	290-00

584. Kohlraush Flasks (Mud Flask) "LABCO", with cup at top

Cat. No.	Capacity ml.	Min. Qty./Pack	Class 'A' Rs/Piece	Class 'B' Rs/Piece
584/1	50	2	350-00	200-00
584/2	100	2	390-00	250-00
584/3	200	2	515-00	350-00

588. Lechatelier Flask, "LABCO", for Sp.Gr. Test, Bulb Capacity approx. 250ml, neck graduation from 0 to 1ml and 18 to 24ml in 0.1ml

1300-00

589. - do - Class 'A'

1875-00

590 Sulphonation Flask with neck graduated 0 to 10 ml. and figured to 100% as per ASTM or I.P.

835-00

590A Silicon Rubber, Safety Rider, Hexagonal Shape for Volumetric Flask

Cat. No.	Colour	Suitable for	Minimum Qty./Pack	Price/Piece Rs.
590A/1	Yellow	5ml-25ml	10	33-00
590A/2	Green	50ml	10	38-00
590A/3	Blue	100ml-250ml	10	62-00
590A/4	Orange	500ml	10	175-00
590A/5	Red	1000 ml	10	265-00

MEASURING CYLINDERS

598. Measuring Cylinder "LABCO", with break resistant collar & spout, Class 'A', IS 878 : 2008, with works Certificate, Hexagonal Base

Cat. No.	Capacity ml.	Sub. Div. ml.	Tolerance \pm ml.	Min. Qty./Pack	Price/Piece Rs.
598/1	5	0.1	0.05	2	295-00
598/2	10	0.2	0.10	2	325-00
598/3	25	0.5	0.25	2	350-00
598/4	50	1.0	0.50	2	440-00
598/5	100	1.0	0.50	2	540-00
598/6	250	2.0	1.00	2	820-00
598/7	500	5.0	2.50	1	1180-00
598/8	1000	10.0	5.00	1	1400-00
598/9	2000	20.0	10.00	1	2300-00

598L. Measuring Cylinder "LABCO", with break resistant collar & spout, Class 'A', IS 878 : 2008, with **NABL** Certificate, Hexagonal Base

Cat. No.	Capacity ml.	Sub. Div. ml.	Tolerance \pm ml.	Price/Piece Rs.
598L/1	5	0.1	0.05	690-00
598L/2	10	0.2	0.10	710-00
598L/3	25	0.5	0.25	730-00
598L/4	50	1.0	0.50	800-00
598L/5	100	1.0	0.50	880-00
598L/6	250	2.0	1.00	1075-00
598L/7	500	5.0	2.50	1475-00
598L/8	1000	10.0	5.00	1750-00
598L/9	2000	20.0	10.00	2800-00

598M Amber Colour Cylinders, "LABCO", with break resistant collar & spout, Class 'A', IS 878 : 2008, & Hexagonal base.

Cat. No.	Capacity ml.	Sub Div ml.	Min. Qty./Pack	Price/Piece Rs.
598M/1	5	0.1	2	385-00
598M/2	10	0.2	2	410-00
598M/3	25	0.5	2	495-00
598M/4	50	1.0	2	555-00
598M/5	100	1.0	2	685-00
598M/6	250	2.0	2	1025-00
598M/7	500	5.0	1	1500-00
598M/8	1000	10.0	1	2100-00
598M/9	2000	20.0	1	3400-00

598ML Amber Colour Measuring Cylinder "LABCO", with break resistant collar & spout, Hexagonal Base, Accuracy as per, Class 'A', I.S 878 : 2008, with **NABL** works Certificate.

Cat. No.	Capacity ml.	Sub. Div. ml.	Tolerance \pm ml.	Min. Qty./Pack	Price/Piece Rs.
598ML/1	5	0.1	0.05	2	750-00
598ML/2	10	0.2	0.10	2	750-00
598ML/3	25	0.5	0.25	2	800-00
598ML/4	50	1.0	0.50	2	880-00
598ML/5	100	1.0	0.50	2	940-00
598ML/6	250	2.0	1.00	2	1275-00
598ML/7	500	5.0	2.50	2	1750-00
598ML/8	1000	10.0	5.00	2	2340-00

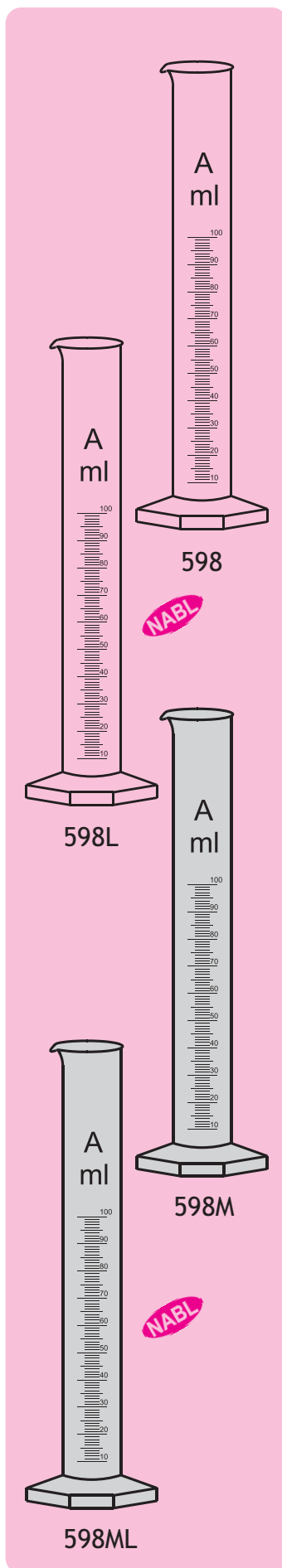

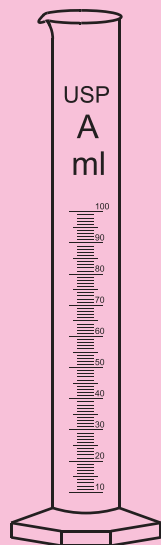

598a

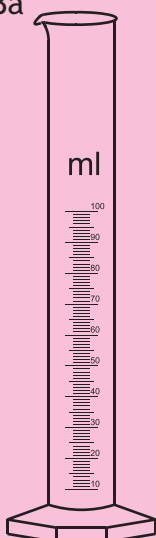

598b

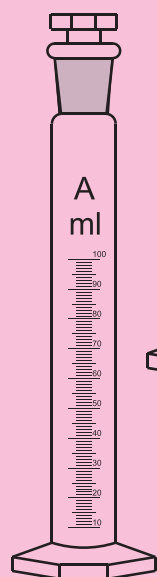

599

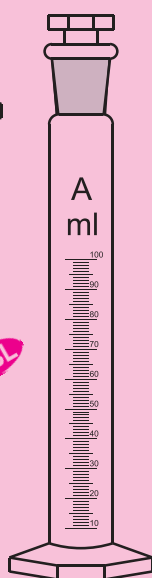

599L



598a. Measuring Cylinder "LABCO", with spout, Hexagonal Base, as per ASTM, **Class 'A' USP (US Pharmacopeia)** with certificate. Accuracy as per ASTM E1272

Cat. No.	Capacity ml.	Sub. Div. ml.	Tolerance \pm ml.	Min. Qty./Pack	Price/Piece Rs.
598a/1	5	0.1	0.05	2	310-00
598a/2	10	0.2	0.10	2	350-00
598a/3	25	0.5	0.17	2	375-00
598a/4	50	1	0.25	2	470-00
598a/5	100	1	0.50	2	575-00
598a/6	250	2	1.00	2	885-00
598a/7	500	5	2.00	2	1275-00
598a/8	1000	10	3.00	2	1550-00
598a/9	2000	20	6.00	2	2500-00

598b. Measuring Cylinder "LABCO", with spout, Hexagonal Base, Accuracy as per **Class 'B', IS 878 : 2008.**

Cat. No.	Capacity ml.	Sub. Div. ml.	Tolerance \pm ml.	Min. Qty./Pack	Price/Piece Rs.
598b/1	5	0.1	0.10	2	195-00
598b/2	10	0.2	0.20	2	200-00
598b/3	25	0.5	0.50	2	240-00
598b/4	50	1	1.00	2	265-00
598b/5	100	1	1.00	2	310-00
598b/6	250	2	2.00	2	545-00
598b/7	500	5	5.00	2	750-00
598b/8	1000	10	10.00	2	1125-00
598b/9	2000	20	20.00	2	2100-00

599. Measuring Cylinder "LABCO", with interchangeable stopper, **Class 'A',** of IS 878 : 2008, with works Certificate, **Hexagonal Base**

Cat. No.	Capacity ml.	Sub. Div. ml.	Tolerance \pm ml.	Min. Qty./Pack	Price/Piece Rs.
599/1	5	0.1	0.05	2	400-00
599/2	10	0.2	0.10	2	410-00
599/3	25	0.5	0.25	2	455-00
599/4	50	1.0	0.50	2	610-00
599/5	100	1.0	0.50	2	710-00
599/6	250	2.0	1.00	2	1140-00
599/7	500	5.0	2.50	2	1825-00
599/8	1000	10.0	5.00	2	2200-00
599/9	2000	20.0	10.00	2	3375-00

599L. Measuring Cylinder "LABCO", with interchangeable stopper, **Class 'A',** of IS 878 : 2008, with **NABL** Certificate, **Hexagonal Base**

Cat. No.	Capacity ml.	Sub. Div. ml.	Tolerance \pm ml.	Price/Piece Rs.
599L/1	5	0.1	0.05	755-00
599L/2	10	0.2	0.10	775-00
599L/3	25	0.5	0.25	800-00
599L/4	50	1.0	0.50	900-00
599L/5	100	1.0	0.50	950-00
599L/6	250	2.0	1.00	1250-00
599L/7	500	5.0	2.50	1900-00
599L/8	1000	10.0	5.00	2100-00
599L/9	2000	20.0	10.00	3600-00

599M Amber Colour Cylinders, Graduated, "LABCO", Class 'A', with interchangeable stopper Accuracy as per I.S. 878 : 2008 Hexagonal Base

Cat. No.	Capacity ml.	Sub Div ml.	Min. Qty./Pack	Price/Piece Rs.
599M/1	5	0.1	2	535-00
599M/2	10	0.2	2	550-00
599M/3	25	0.5	2	590-00
599M/4	50	1.0	2	775-00
599M/5	100	1.0	2	915-00
599M/6	250	2.0	2	1400-00
599M/7	500	5.0	2	2180-00
599M/8	1000	10.0	2	2950-00
599M/9	2000	20.0	2	4500-00

599ML Amber Colour Measuring Cylinder "LABCO", with interchangeable stopper Hexagonal Base, Accuracy as per, Class 'A', of I.S 878 : 2008, with NABL works Certificate.

Cat. No.	Capacity ml.	Sub. Div. ml.	Tolerance ± ml.	Min. Qty./Pack	Price/Piece Rs.
599ML/1	5	0.1	0.05	2	850-00
599ML/2	10	0.2	0.10	2	875-00
599ML/3	25	0.5	0.25	2	910-00
599ML/4	50	1.0	0.50	2	1050-00
599ML/5	100	1.0	0.50	2	1200-00
599ML/6	250	2.0	1.00	2	1700-00
599ML/7	500	5.0	2.50	2	2500-00
599ML/8	1000	10.0	5.00	2	3300-00

600 Measuring Cylinders, "LABCO", with break resistant collar & spout, Round Base, Accuracy as per Class 'A', of I.S 878 : 2008, with works certificate.

Cat. No.	Capacity ml.	Sub. Div. ml.	Tolerance ± ml.	Min. Qty./Pack	Price/Piece Rs.
600/1	5	0.1	0.05	2	180-00
600/2	10	0.2	0.10	2	190-00
600/3	25	0.5	0.25	2	240-00
600/4	50	1.0	0.50	2	325-00
600/5	100	1.0	0.50	2	390-00
600/6	250	2.0	1.00	2	725-00
600/7	500	5.0	2.50	2	1300-00
600/8	1000	10.0	5.00	2	1450-00
600/9	2000	20.0	10.0	2	2275-00

601a Measuring Cylinder, "LABCO", with spout and break resistant collar, Class 'B', (Light wall)

Cat. No.	Capacity ml.	Sub. Div. ml.	Tolerance ± ml.	Min. Qty./Pack	Price/Piece Rs.
601a/1	5	0.1	0.1	2	115-00
601a/2	10	0.2	0.2	2	120-00
601a/3	25	0.5	0.5	2	155-00
601a/4	50	1.0	1.0	2	190-00
601a/5	100	1.0	1.0	2	235-00
601a/6	250	2.0	2.0	2	455-00
601a/7	500	5.0	5.0	2	685-00
601a/8	1000	10.0	10.0	2	1100.00
601a/9	2000	20.0	20.0	2	1925-00

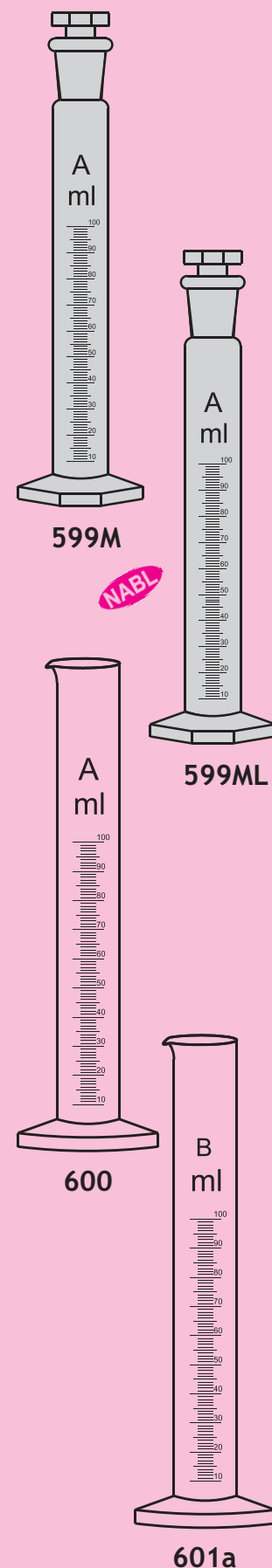

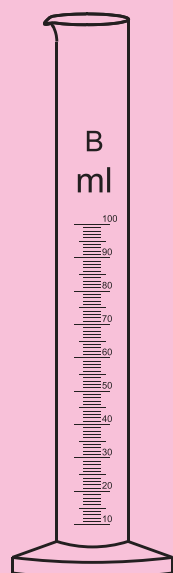

601b

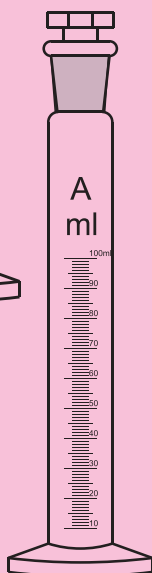

602

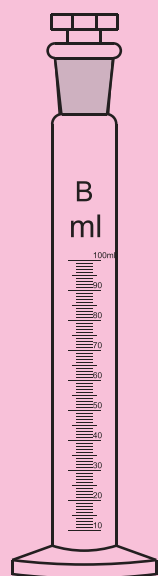

603

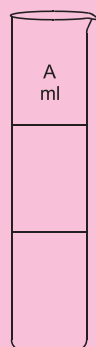

605

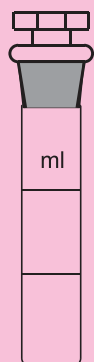

605a

601b Measuring Cylinder, "LABCO", with spout and break resistant collar, Class 'B' (Medium wall)

Cat. No.	Capacity ml.	Sub. Div. ml.	Tolerance ± ml.	Min Qty./Pack	Price/Piece Rs.
601b/1	5	0.1	0.1	2	140-00
601b/2	10	0.2	0.2	2	150-00
601b/3	25	0.5	0.5	2	190-00
601b/4	50	1.0	1.0	2	210-00
601b/5	100	1.0	1.0	2	255-00
601b/6	250	2.0	2.0	2	510-00
601b/7	500	5.0	5.0	2	725-00
601b/8	1000	10.0	5.0	2	1150-00
601b/9	2000	20.0	20.0	2	2000-00

602 Measuring Cylinders, "LABCO", with interchangeable stopper, Class 'A', of IS 878 : 2008, with works certificate.

Cat. No.	Capacity ml.	Sub. Div. ml.	Tolerance ± ml.	Min. Qty./Pack	Price/Piece Rs.
602/1	5	0.1	0.05	2	270-00
602/2	10	0.2	0.10	2	275-00
602/3	25	0.5	0.25	2	325-00
602/4	50	1.0	0.50	2	390-00
602/5	100	1.0	0.50	2	470-00
602/6	250	2.0	1.00	2	855-00
602/7	500	5.0	2.50	2	1570-00
602/8	1000	10.0	5.00	2	1770-00
602/9	2000	20.0	20.0	2	2550-00

603 Measuring Cylinder, "LABCO", with interchangeable stopper, Class 'B'

Cat. No.	Capacity ml.	Sub. Div. ml.	Tolerance ± ml.	Min. Qty./Pack	Price/Piece Rs.
603/1	5	0.1	0.1	2	180-00
603/2	10	0.2	0.2	2	195-00
603/3	25	0.5	0.5	2	260-00
603/4	50	1.0	1.0	2	300-00
603/5	100	1.0	1.0	2	400-00
603/6	250	2.0	2.0	2	650-00
603/7	500	5.0	5.0	2	1000-00
603/8	1000	10.0	10.0	2	1400-00
603/9	2000	20.0	20.0	2	2400-00

605. Nessler Cylinder, "LABCO", for colour comparison Class 'A', with works certificate, graduated as per I.S. 4161 : 1967.

Cat. No.	Capacity ml.	Sub. Div. ml.	Tolerance ± ml.	Min. Qty./Pack	Price/Piece Rs.
605/1	50	25 to 50	0.4	2	180-00
605/2	100	50 & 100	0.8	2	260-00

605a Nessler Cylinder, "LABCO", for colour comparison with interchangeable stopper Class 'A', with works certificate, graduated as per I.S. 4161 : 1967.

Cat. No.	Capacity ml.	Sub. Div. ml.	Tolerance ± ml.	Stopper Size	Min. Qty./Pack	Price/Piece Rs.
605a/1	50	25 to 50	0.4	19/20	12	290-00
605a/2	100	50 & 100	0.8	19/20	12	370-00

606. Nessler Cylinder, "LABCO", for colour comparison graduated as per I.S. 4161 : 1967.

Cat. No.	Capacity ml.	Sub. Div. ml.	Min. Qty./Pack	Price/Piece Rs.
606/1	50	25 & 50	2	115-00
606/2	100	50 & 100	2	150-00

607. Crow Receiver, "LABCO", Class 'B'

Cat. No.	Capacity ml.	Min. Qty./Pack	Plain	With Stopper Interchangeable
607/1	50	2	380-00	440-00
607/2	100	2	500-00	570-00

608. Crow Receiver, "LABCO", accuracy as per Class 'A', with certificate

Cat. No.	Capacity ml.	Min. Qty./Pack	Plain	With Stopper Interchangeable
608/1	50	2	485-00	625-00
608/2	100	2	590-00	760-00

609. Cylinder "LABCO", With single graduation mark at 1000 ml for Sedimentation of sand. 1025-00

610. Bulk Density Cylinder (Vankle's Design) As per USP Specs, Hexa Round base 2 790-00

611. Cylinder, Rain Measure "LABCO", Metric Scale graduated as per I.S. 4849 : 1992.

Cat. No.	Size mm	Collector Area Cm ²	Sub. Div. ml.	Tolerance ± ml.	Min. Qty./Pack	Price/Piece Rs.
611/1	20	200	0.2	0.05	12	875-00
611/2	100	100	0.2	0.10	12	750-00

IMHOFF CONES

615. Cones, Imhoff, Sediment, Sharp Tip, "LABCO", Graduated from 0 to 1 ml in 0.1 ml division, 1 to 10 ml in 0.5 ml and 10 to 40 ml in 1 ml, Also marked at 1000 ml approx. Total height 454 mm, approx. Top dia 100 mm. 3900-00

616. Cones, Imhoff, Sediment, Blunt Tip, "LABCO", Graduated from 0 to 1 ml in 0.1 ml division, 1 to 10 ml in 0.5 ml and 10 to 40 ml in 1 ml, approx Top Dia 100 mm 3900-00

617. Stand for cone, Imhoff 3150-00

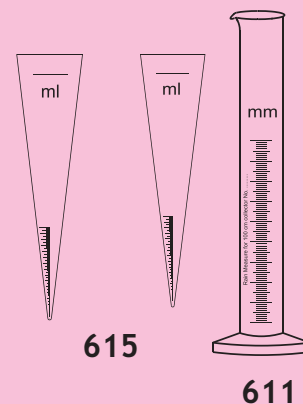
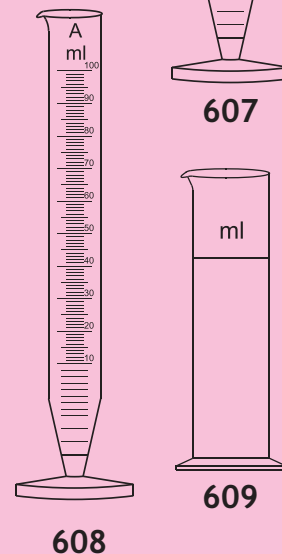
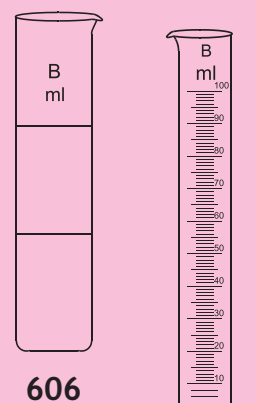

TUBES

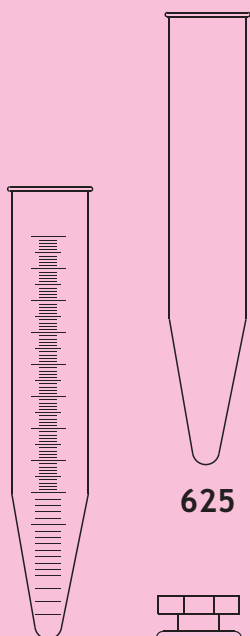

625

626

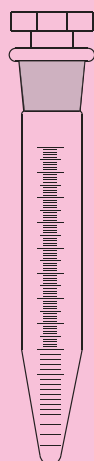

627

628

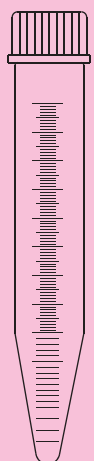

629

630

625 Centrifuge Tube "LABCO", Conical bottom plain.

Cat No.	Capacity ml.	Ht. x O.D. mm.	Min. Qty./Pack	Price/Piece Rs.
625/1	3	76 x 10	25	20-00
625/2	5	100 x 13	25	24-00
625/3	10	110 x 15	25	30-00
625/4	12	110 x 16	25	30-00
625/5	15	120 x 17	25	33-00
625/6	25	125 x 22	6	88-00
625/7	50	125 x 28	6	112-00

626 Centrifuge Tube, "LABCO", Conical bottom graduated.

Cat No.	Capacity ml.	Ht. x O.D. mm.	Min. Qty./Pack	Price/Piece Rs.
626/1	5	100 x 13	25	52-00
626/2	10	110 x 15	25	58-00
626/3	15	120 x 17	25	66-00
626/4	25	125 x 22	6	108-00
626/5	50	125 x 28	6	134-00

627 Centrifuge Tube, "LABCO", Plain with interchangeable stopper conical or round bottom.

Cat No.	Capacity ml.	Size Approx. mm.	Min. Qty./Pack	Price/Piece Rs.
627/1	3	76 x 10	10	74-00
627/2	5	100 x 13	10	80-00
627/3	12	110 x 16	10	86-00
627/4	15	120 x 17	10	90-00
627/5	25	125 x 22	6	136-00

628 Centrifuge Tube, "LABCO", Conical bottom Graduated with interchangeable stopper.

Cat No.	Capacity ml.	Min. Qty./Pack	Price/Piece Rs.
628/1	5	10	99-00
628/2	10	10	105-00
628/3	15	10	115-00
628/4	25	6	178-00
628/5	50	6	220-00

629 Centrifuge Tube, "LABCO", with Screw Cap, Plain.

Cat No.	Capacity ml.	Ht. x O.D. mm.	Min. Qty./Pack	Price/Piece Rs.
629/1	10	110 x 15	10	72-00
629/2	15	120 x 17	10	75-00

630 Centrifuge Tube, "LABCO", with Screw Cap, Graduated.

Cat No.	Capacity ml.	Ht. x O.D. mm.	Min. Qty./Pack	Price/Piece Rs.
630/1	10	110 x 15	10	105-00
630/2	15	120 x 17	10	115-00

631 Centrifuge Tube, "LABCO", Round bottom, Graduated.

Cat No.	Capacity ml.	Size mm.	Min. Qty./Pack	Price/Piece Rs.
631/1	12	16 x 110	10	75-00
631/2	30	24 x 110	6	85-00
631/3	40	28 x 110	6	105-00
631/4	50	30 x 110	6	115-00
631/5	100	45 x 110	6	330-00
631/6	200	55 x 116	6	400-00

634 Centrifuge Tubes, Oil "LABCO", fully graduated 0 to 0.5ml. in 0.05 ml div., 0.5 to 2 ml in 0.1 ml div., 2 ml to 3 ml in 0.2 ml div., 3 ml to 5 ml in 0.5 ml div. 5ml to 10 ml in 1 ml div., 10 ml to 25 ml in 5 ml div. Graduations are marked at 50, 75 and 100 ml. 790-00

635 Centrifuge Tubes, Oil "LABCO", the lower stem is graduated 0 to 1.5 ml in 0.1 ml div., the body is graduated 1.5 ml to 5 ml div. in 0.5 ml div., from 5 ml to 10 ml in 1 ml div., Graduations are also marked at 15,20,25,50and100ml. 800-00

637 Test Tubes, "LABCO", Round bottom with Rim, plain. Made from Boro 3.3 Exp. Glass

Cat No.	Capacity ml.	O.D. x L mm.	Min. Qty./Pack	Price/Piece Rs.
637/1	3	10 x 75	100	6-70
637/2	5	12 x 75	100	6-90
637/3	8	12 x 100	100	8-70
637/4	10	15 x 125	100	12-75
637/5	15	15 x 150	100	13-75
637/6	25	18 x 150	100	15-50
637/7	35	25 x 100	50	19-50
637/8	50	25 x 150	50	23-50
637/9	75	25 x 200	50	28-50
637/10	100	32 x 200	25	48-00
637/11	175	38 x 200	25	58-00

637a Test Tubes, "LABCO", Round bottom without Rim, plain. Made from Boro 3.3 Exp. Glass

Cat No.	Capacity ml.	O.D. x L mm.	Min. Qty./Pack	Price/Piece Rs.
637a/1	3	10 x 75	100	6-70
637a/2	5	12 x 75	100	6-90
637a/3	8	12 x 100	100	8-70
637a/4	10	15 x 125	100	12-75
637a/5	15	15 x 150	100	13-75
637a/6	25	18 x 150	100	15-50
637a/7	35	25 x 100	50	19-50
637a/8	50	25 x 150	50	23-50
637a/9	75	25 x 200	50	28-50
637a/10	100	32 x 200	25	48-00
637a/11	175	38 x 200	25	58-00

638 Test Tubes, "LABCO", Round bottom with Rim, Made from Boro 3.3 Exp. Glass Graduated.

Cat No.	Capacity ml.	O.D. x L x Wt. mm.	Min. Qty./Pack	Price/Piece Rs.
638/1	3	10 x 75 x 1.0	10	33-00
638/2	5	12 x 75 x 1.0	10	35-00
638/3	8	12 x 100 x 1.0	10	42-00
638/4	10	15 x 125 x 1.2	10	45-00
638/5	25	18 x 150 x 1.2	10	58-00
638/6	50	25 x 150 x 1.2	10	68-00
638/7	75	25 x 200 x 1.2	10	78-00

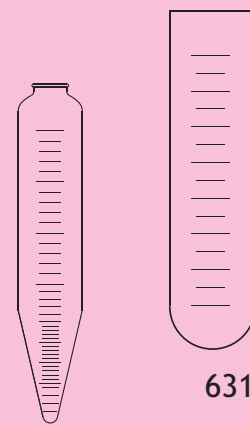

631

634

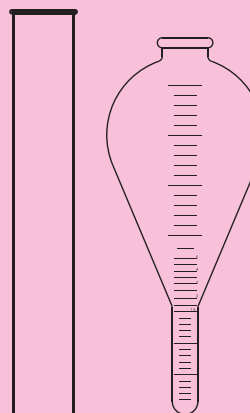

635

637

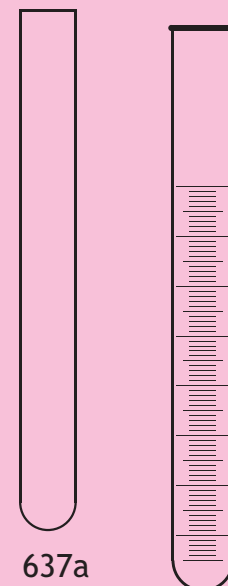

637a

638

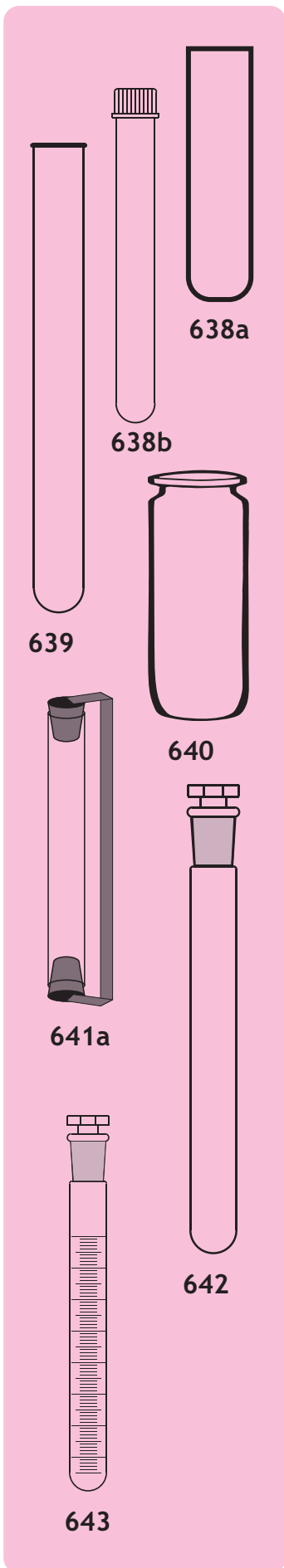

- 638a Sterility tubes "LABCO", for Sterilization purpose, heavy type Rimless 200mm length 110-00
- 638b --- do --- same as above but with Teflon liner screw cap. 225-00
- 638c Sterility tube stand "LABCO", made from S.S. 304, nicely finished & polished, for 12 tubes 1650-00

639 Test Tubes, "LABCO", Neutral Hard Glass, Round Bottom,

Cat No.	Size. Approx. mm.	Pack of 100 pcs.
639/1	10 x 75	305-00
639/2	12 x 75	350-00
639/3	12 x 100	385-00
639/4	15 x 100	440-00
639/5	15 x 125	560-00
639/6	15 x 150	675-00
639/7	18 x 150	800-00
639/8	25 x 150	1175-00
639/9	25 x 200	1425-00

640 Pressure Test Tubes, "LABCO", Penicilin type 20mm neck, 18 x 150mm. 105-00

641 Stoppers for above Pressure Test Tubes (Suba Seals). 58-00

641a Heat Stability tubes "LABCO", Both ends open with silicon corks 72-00

642 Test Tubes, "LABCO", with interchangeable Stopper.

Cat No.	Length x Dia mm.	Stopper Size	Min. Qty./Pack	Price/Piece Rs.
642/1	100 x 12	B 10	10	65-00
642/2	125 x 15	B 10	10	75-00
642/3	150 x 18	B 14	10	88-00
642/4	150 x 25	B 19	10	105-00
642/5	200 x 25	B 19	10	130-00
642/6	200 x 32	B 24	10	180-00
642/7	200 x 38	B 24	10	205-00

643 Test Tubes, "LABCO", Graduated with interchangeable stopper.

Cat. No.	Size mm.	Capacity ml.	Stopper size	Min. Qty./Pack	Price/Piece Rs.
643/1	13 x 100	5	B 10	10	96-00
643/2	15 x 125	10	B 10	10	106-00
643/3	18 x 160	20	B 14	10	130-00
643/4	22 x 150	25	B 19	10	155-00
643/5	25 x 155	30	B 19	10	170-00
643/6	25 x 200	50	B 19	10	190-00
643/7	32 x 230	100	B 24	10	245-00

644. Tubes, Culture, Media, "LABCO", Round Bottom, with Screw Cap and Teflon liner.

Cat. No.	Capacity ml.	O.D. x Length mm.	Min. Qty./Pack	Transparant Price/Piece	Amber Coloured Price/Piece
644/1	5	16 x 75	25	34-00	62-00
644/2	10	16 x 125	25	42-00	72-00
644/3	15	16 x 150	25	45-00	75-00
644/4	25	18 x 150	25	48-00	90-00
644/5	30	25 x 100	25	52-00	92-00
644/6	45	25 x 150	25	56-00	112-00
644/7	60	25 x 200	25	64-00	140-00
644/8	100	32 x 200	25	135-00	225-00
644/9	150	38 x 200	25	230-00	320-00

645. Tubes, Culture, Media, "LABCO", Round Bottom, with Screw Cap and Rubber liner.

Cat. No.	Capacity ml.	O.D. x Length mm.	Min. Qty./Pack	Transparant Price/Piece	Amber Coloured Price/Piece
645/1	5	16 x 75	25	26-00	48-00
645/2	10	16 x 125	25	30-00	52-00
645/3	15	16 x 150	25	35-00	60-00
645/4	25	18 x 150	25	39-00	66-00
645/5	30	25 x 100	25	42-00	72-00
645/6	45	25 x 150	25	48-00	78-00
645/7	60	25 x 200	25	49-00	82-00
645/8	100	32 x 200	25	112-00	188-00
645/9	150	38 x 200	25	210-00	285-00

646 Tubes, Culture, Media, "LABCO", Flat Bottom, with Screw Cap and Teflon liner.

Cat. No.	Capacity ml.	O.D. x Length mm.	Min. Qty./Pack	Transparant Price/Piece	Amber Coloured Price/Piece
646/1	5	16 x 50	25	32-00	62-00
646/2	15	25 x 57	25	41-00	80-00
646/3	30	25 x 95	25	47-00	92-00
646/4	40	25x 145	25	64-00	135-00

647. Tubes, Culture, Media, "LABCO", Flat Bottom, with Screw Cap and Rubber liner.

Cat. No.	Capacity ml.	O.D. x Length mm.	Min. Qty./Pack	Transparant Price/Piece	Amber Coloured Price/Piece
647/1	5	16 x 50	25	26-00	45-00
647/2	15	25 x 57	25	31-00	57-00
647/3	30	25 x 95	25	39-00	66-00
647/4	40	25 x 145	25	45-00	90-00

648. Leighton Tubes, "LABCO", for Culture work, plain top, with Cover slip.

Cat. No.	Length mm.	O.D. mm.	Min. Qty./Pack	Window Size mm.	Price/Piece Rs.
648/1	125	16	10	11 x 37	46-00
648/2	150	16	10	11 x 37	54-00

649 Leighton Tubes, "LABCO", for Culture work, with Screw Cap and Cover slip.

Cat. No.	Length mm.	O.D. mm.	Min. Qty./Pack	Window Size mm.	Price/Piece Rs.
649/1	125	16	10	11 x 37	68-00
649/2	150	16	10	11 x 37	72-00

650 M.B.R. Tubes "LABCO", with two graduated marks. Size 15x150mm 36-00

651 Hungat Vial "LABCO", with inner siliconised septa & bakelite Cap. Capacity 10 ml. 72-00 Ea

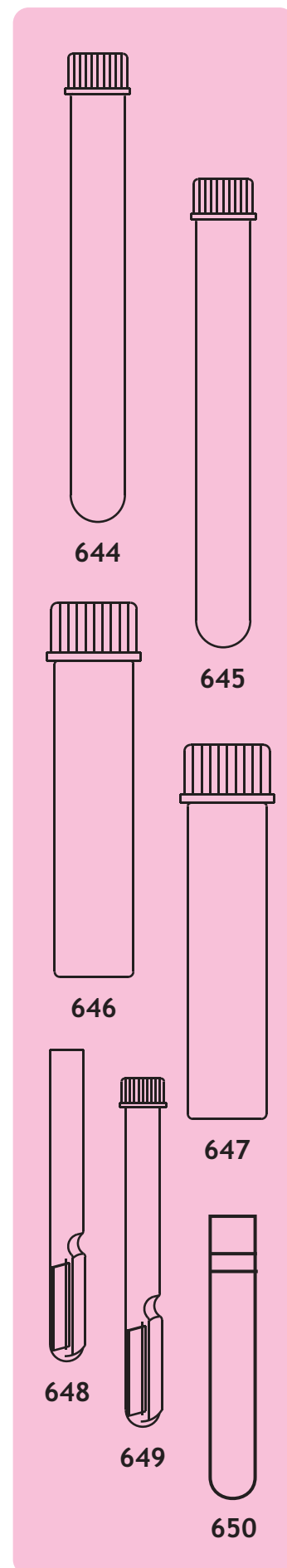

DISTILLATION APPARATUS PARTS (CONDENSERS)

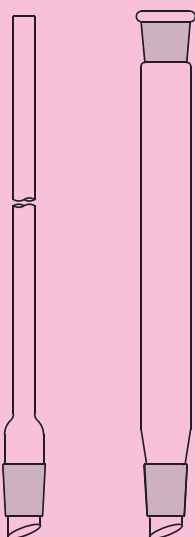

660

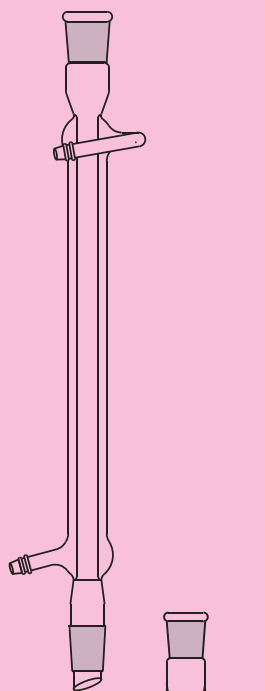

661

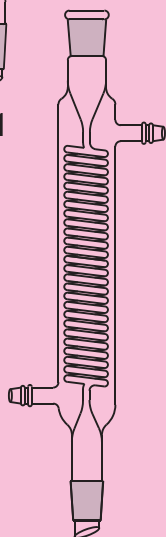

662

660. Air Condensers, "LABCO"

Cat. No.	Socket	Cone	Effective Length mm.	Price/Piece Rs.
660/1	B 14	B 14	200	166-00
660/2	B 19	B 19	200	195-00
660/3	B 24	B 24	250	270-00
660/4	B 19	B 19	400	300-00
660/5	B 24	B 24	500	380-00
660/6	B 34	B 34	500	750-00
660/7	B 19	B 19	600	340-00
660/8	B 24	B 24	750	510-00
660/9	-	B 19	750	200-00
660/10	-	B 24	750	210-00
660/11	-	B 19	1000	235-00
660/12	-	B 24	1000	260-00

661. Liebig Condensers, "LABCO"

Cat. No.	Socket	Cone	Effective Length mm.	Price/Piece Rs.
661/1	B 14	B 14	150	240-00
661/2	B 19	B 19	200	275-00
661/3	B 24	B 24	200	320-00
661/4	B 19	B 19	300	330-00
661/5	B 24	B 24	300	375-00
661/6	B 19	B 19	350	390-00
661/7	B 24	B 24	350	400-00
661/8	B 19	B 19	400	400-00
661/9	B 24	B 24	400	415-00
661/10	B 24	B 24	500	500-00
661/11	B 24	B 24	600	560-00
661/12	B 24	B 24	750	825-00
661/13	B 34	B 34	500	925-00
661/14	B 34	B 34	600	1025-00
661/15	B 34	B 34	750	1100-00
661/16	B 34	B 34	900	1300-00
661/17	-	B 19	300	315-00
661/18	-	B 24	350	375-00
661/19	-	B 34	250	395-00

662. Coil Condensers, "LABCO", Graham, Coiled Distillate Type.

Cat. No.	Socket	Cone	Effective Length mm.	Price/Piece Rs.
662/1	B 14	B 14	150	490-00
662/2	B 19	B 19	200	525-00
662/3	B 19	B 19	250	540-00
662/4	B 24	B 24	250	585-00
662/5	B 19	B 19	300	600-00
662/6	B 24	B 24	300	660-00
662/7	B 24	B 24	400	750-00
662/8	B 24	B 24	500	780-00
662/9	B 34	B 34	500	1050-00
662/10	B 34	B 34	600	1150-00

663. Coil Condensers, "LABCO", Graham, Jacket Distillate Type.

Cat. No.	Socket	Cone	Effective Length mm.	Price/Piece Rs.
663/1	B 14	B 14	150	500-00
663/2	B 19	B 19	200	525-00
663/3	B 19	B 19	250	550-00
663/4	B 24	B 24	250	585-00
663/5	B 19	B 19	300	600-00
663/6	B 24	B 24	300	665-00
663/7	B 24	B 24	400	750-00
663/8	B 24	B 24	500	775-00
663/9	B 34	B 34	500	1050-00
663/10	B 34	B 34	600	1100-00

664. Reversible Type Condensers, "LABCO".

Cat. No.	Socket	Cone	Effective Length mm.	Price/Piece Rs.
664/1	-	B 19 & B 24	150	585-00
664/2	-	B 24 & B 24	150	635-00
664/3	-	B 24 & B 34	150	700-00

665. Double Coil Condensers, "LABCO", with common inlet.

Cat. No.	Socket	Cone	Effective Length mm.	Price/Piece Rs.
665/1	B 19	B 19	200	1250-00
665/2	B 24	B 24	200	1290-00
665/3	B 34	B 34	350	3050-00
665/4	B 34	B 34	450	4600-00
665/5	B 34	B 34	600	5350-00

666. Davies Condensers, "LABCO", (Double Surface).

Cat. No.	Socket	Cone	Effective Length mm.	Price/Piece Rs.
666/1	B 19	B 19	150	585-00
666/2	B 24	B 24	150	600-00
666/3	B 19	B 19	200	660-00
666/4	B 24	B 24	200	675-00
666/5	B 29	B 29	200	685-00
666/6	-	B 19	200	615-00
666/7	-	B 24	200	620-00
666/8	-	B 34	200	660-00
666/9	-	B 19	250	650-00
666/10	B 19	B 19	250	690-00
666/11	B 24	B 24	250	700-00
666/12	B 19	B 19	300	785-00
666/13	B 24	B 24	300	800-00
666/14	B 24	B 24	400	900-00
666/15	B 24	B 24	500	1275-00
666/16	B 34	B 34	500	1365-00
666/17	B 34	B 34	600	1580-00

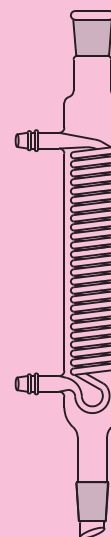

663

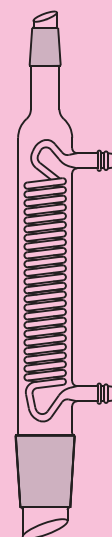

664

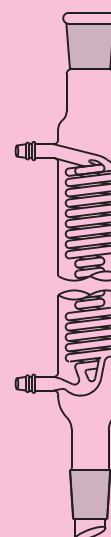

665

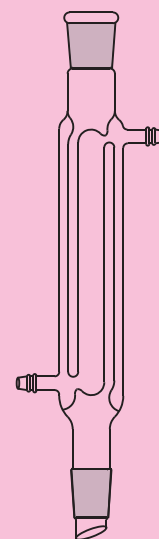

666

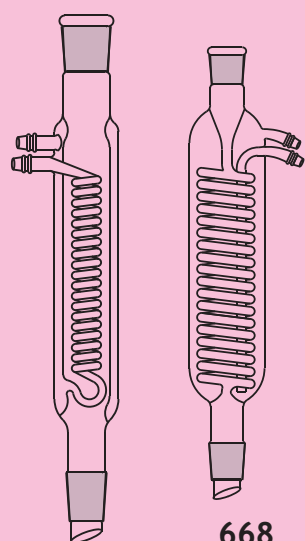

667

668

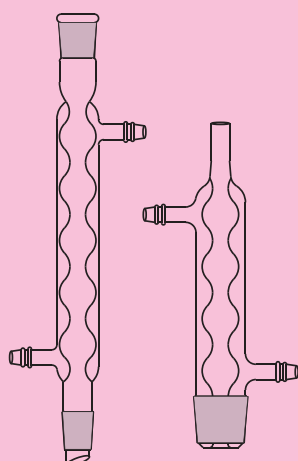

669

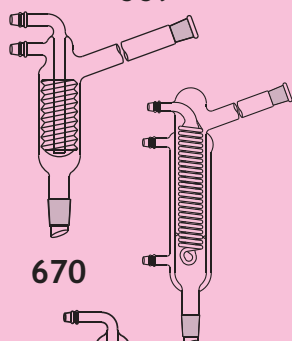

670

671



672

667. Jacketed Coil Condensers, "LABCO".

Cat. No.	Socket	Cone	Effective Length mm.	Price/Piece Rs.
667/1	B 19	B 19	150	675-00
667/2	B 24	B 24	150	690-00
667/3	-	B 34	150	675-00
667/4	-	B 40	150	740-00
667/5	B 19	B 19	200	740-00
667/6	B 24	B 24	200	750-00
667/7	B 19	B 19	300	870-00
667/8	B 24	B 24	300	880-00
667/9	B 24	B 24	400	1050-00
667/10	B 34	B 34	400	1150-00
667/11	B 34	B 34	500	1675-00

668. Inland Revenue Condensers, "LABCO".

Cat. No.	Socket	Cone	Effective Length mm.	Price/Piece Rs.
668/1	B 19	B 19	200	880-00
668/2	B 24	B 24	200	900-00

669. Allihan Condensers, "LABCO", (Bulb Condenser).

Cat. No.	Socket	Cone	Effective Length mm.	Price/Piece Rs.
669/1	-	B 19	200	418-00
669/2	-	B 24	200	435-00
669/3	-	B 29	200	435-00
669/4	-	B 34	200	418-00
669/5	-	B 40	200	475-00
669/6	-	B 50	200	615-00
669/7	-	B 50	250	725-00
669/8	B 19	B 19	200	415-00
669/9	B 24	B 24	200	465-00
669/10	B 19	B 19	300	520-00
669/11	B 24	B 24	300	540-00
669/12	B 24	B 24	400	630-00
669/13	B 24	B 24	500	775-00
669/14	B 34	B 34	500	865-00
669/15	B 34	B 34	600	925-00
669/16	B 34	B 34	750	1675-00

670. Friedrich Condensers, "LABCO".

Cat. No.	Socket	Cone	Effective Length mm.	Price/Piece Rs.
670/1	B 19	B 19	100	1700-00
670/2	B 19 or B 24	B 19 or B 24	200	1825-00
670/3	B 19 or B 24	B 19 or B 24	250	1975-00

671. Ether Condensers, "LABCO".

Cat. No.	Socket	Cone	Effective Length mm.	Price/Piece Rs.
671/1	B 19	B 24	150	2250-00
671/2	B 19 or B 24	B 24	200	2400-00
671/3	B 19 or B 24	B 24	250	2550-00

672. Cold Finger Condensers "LABCO", 130mm. immersion, Cone B 19. 195-00

673 Water filled bulb type Condensor 575-00

674. Condensers, "LABCO", Bulb shape, suitable for 1000ml., spoutless, Tall form, Beaker. 640-00

FLASKS

685. Flasks Reaction, "LABCO", Wide Mouth, Flat flange 100 mm. I.D., 150 mm. O.D.

Cat. No.	Capacity (ml)	Price/Piece Rs.
685/1	1000	2125-00
685/2	2000	3050-00
685/3	3000	3800-00
685/4	5000	5125-00
685/5	10000	7900-00
685/6	20000	13900-00

686. Lids For Reaction Flasks, "LABCO", Flat flange 100 mm. I.D., 150 mm. O.D., with multiple Sockets.

Cat. No.	Central	Parallel	5°	10°	15°	Price/Piece Rs.
686/1	B 19	B 19	B 24	B 19	-	3750-00
686/2	B 19	B 14	B 14	B 14	B 29	3785-00
686/3	B 29	B 14	B 14	B 14	B 29	3950-00

687. Stainless Steel Clips, with wing nuts for holding 100 mm. flat flanges. 600-00

688. Teflon Gaskets, for 100 mm. flat flange. 700-00

688a Kettles, Resin Reaction, "LABCO".

Cat No.	Capacity ml.	Price/Piece Rs.
688a/1	500 ml.	8900-00
688a/2	1000 ml.	9500-00
688a/3	2000 ml.	12500-00
688a/4	4000 ml.	14500-00

689M Amber colour Flask Flat or Round Bottom "LABCO", Short or Medium Neck with Interchangeable socket.

Cat. No.	Capacity Qty./Pack	Minimum Rs.	Price/Piece
689M/1	25ml.	12	310-00
689M/2	50ml.	12	325-00
689M/3	100ml.	12	475-00
689M/4	150ml.	12	550-00
689M/5	250ml.	12	620-00
689M/6	500ml.	12	885-00
689M/7	1000ml.	6	1050-00
689M/8	2000ml.	6	1850-00

Note:- While Ordering, do mention Flask required flat or round bottom.

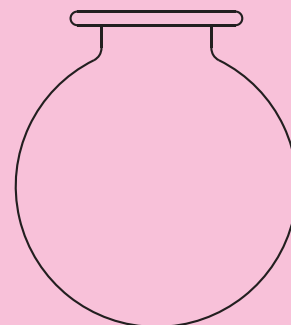

685

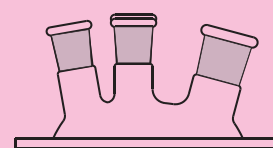

686

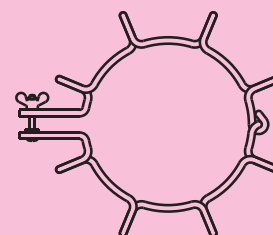

687

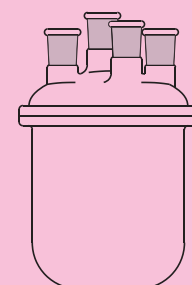

688a

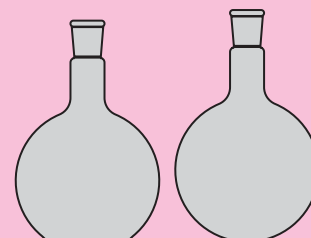

689M

689. Flasks Flat or Round Bottom, "LABCO", Short or Medium neck with socket.

Cat. No.	Capacity ml.	Socket Size	Min. Qty./Pack	Price/Piece Rs.
689/1	5	B 10	10	88-00
689/2	5	B 14	10	88-00
689/3	10	B 10	10	88-00
689/4	10	B 14	10	88-00
689/5	25	B 14	10	116-00
689/6	25	B 19	10	116-00
689/7	25	B 24	10	128-00
689/8	50	B 14	10	138-00
689/9	50	B 19	10	138-00
689/10	50	B 24	10	138-00
689/11	50	B 29	10	138-00
689/12	50	B 34	10	148-00
689/13	100	B 14	10	154-00
689/14	100	B 19	10	154-00
689/15	100	B 24	10	154-00
689/16	100	B 29	10	154-00
689/17	100	B 34	2	154-00
689/18	150	B 19	10	168-00
689/19	150	B 24	10	168-00
689/20	150	B 29	2	168-00
689/21	150	B 34	2	168-00
689/22	250	B 19	10	188-00
689/23	250	B 24	10	188-00
689/24	250	B 29	2	188-00
689/25	250	B 34	2	188-00
689/26	500	B 19	2	265-00
689/27	500	B 24	2	265-00
689/28	500	B 29	2	265-00
689/29	500	B 34	2	265-00
689/30	1000	B 24	2	385-00
689/31	1000	B 29	2	385-00
689/32	1000	B 34	2	385-00
689/33	2000	B 24	2	1080-00
689/34	2000	B 29	2	1080-00
689/35	2000	B 34	2	1080-00
689/36	3000	B 24	1	1975-00
689/37	3000	B 34	1	1975-00
689/38	3000	B 40	1	1975-00
689/39	5000	B 24	1	3075-00
689/40	5000	B 34	1	3075-00
689/41	5000	B 40	1	3075-00
689/42	5000	B 45	1	3075-00
689/43	5000	B 50	1	3075-00
689/44	10000	B 34	1	5550-00
689/45	10000	B 40	1	5550-00
689/46	10000	B 45	1	5550-00
689/47	10000	B 50	1	5550-00
689/48	10000	B 55	1	5550-00
689/49	20000	B 40	1	10800-00
689/50	20000	B 50	1	10800-00
689/51	20000	B 55	1	10800-00

Note:- While Ordering, do mention Flask required flat or round bottom.

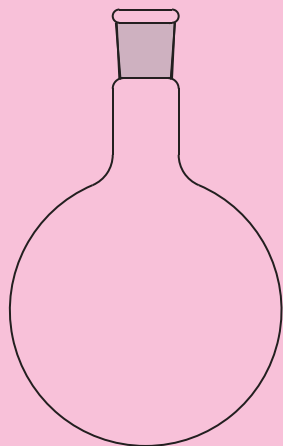

689

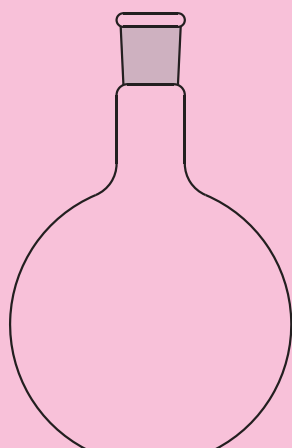

689

690. Flasks Round Bottom, Two Neck "LABCO", either angle or parallel.

Cat. No.	Capacity ml.	Centre Socket	Side Socket	Price/Piece Rs.
690/1	25	B 19	B 14	220-00
690/2	25	B 24	B 19	220-00
690/3	50	B 19	B 14	230-00
690/4	50	B 24	B 19	230-00
690/5	100	B 24	B 14	225-00
690/6	250	B 24	B 14	300-00
690/7	250	B 24	B 19	300-00
690/8	500	B 24	B 14	425-00
690/9	500	B 24	B 19	425-00
690/10	1000	B 34	B 14	675-00
690/11	1000	B 34	B 19	675-00
690/12	1000	B 24	B 14	675-00
690/13	1000	B 24	B 19	675-00
690/14	2000	B 34	B 19	1375-00
690/15	2000	B 34	B 24	1375-00
690/16	2000	B 24	B 19	1375-00
690/17	2000	B 24	B 24	1375-00
690/18	3000	B 34	B 24	2475-00
690/19	3000	B 34	B 19	2475-00
690/20	3000	B 34	B 14	2475-00
690/21	3000	B 24	B 24	2475-00
690/22	3000	B 24	B 19	2475-00
690/23	3000	B 24	B 14	2475-00
690/24	5000	B 40	B 24	3675-00
690/25	5000	B 40	B 19	3675-00
690/26	5000	B 40	B 14	3675-00
690/27	5000	B 34	B 24	3675-00
690/28	5000	B 34	B 19	3675-00
690/29	5000	B 34	B 14	3675-00
690/30	5000	B 24	B 24	3675-00
690/31	5000	B 24	B 19	3675-00
690/32	5000	B 24	B 14	3675-00
690/33	10000	B 55	B 34	6300-00
690/34	10000	B 55	B 24	6300-00
690/35	10000	B 55	B 19	6300-00
690/36	10000	B 50	B 34	6300-00
690/37	10000	B 50	B 24	6300-00
690/38	10000	B 50	B 19	6300-00
690/39	20000	B 55	B 34	11000-00
690/40	20000	B 55	B 24	11000-00
690/41	20000	B 55	B 19	11000-00
690/42	20000	B 50	B 34	11000-00
690/43	20000	B 50	B 24	11000-00
690/44	20000	B 50	B 19	11000-00

Note:- While Ordering, do mention necks at Flask required angle or at Parallel.

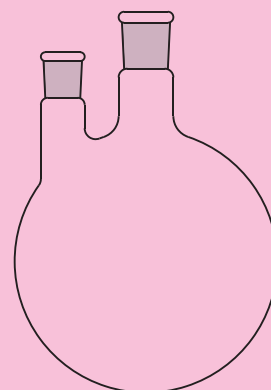

690

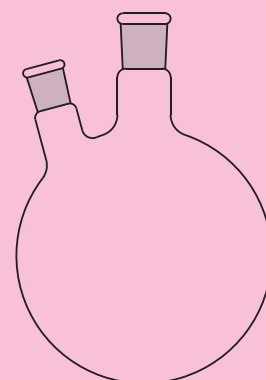

690

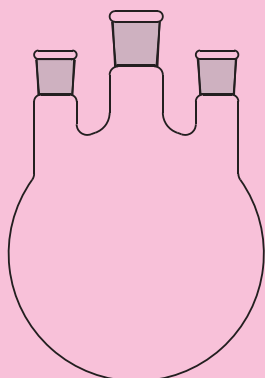

691

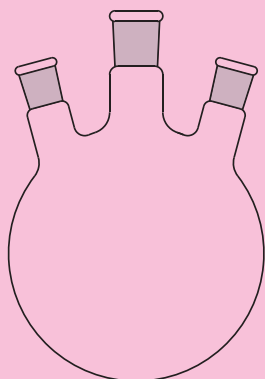

691

691. Flask Round Bottom, "LABCO", Three neck, side neck, either angle or parallel.

Cat. No.	Capacity ml.	Centre Socket	Side Sockets	Price/Piece Rs.
691/1	100	B 24	B 14	310-00
691/2	250	B 24	B 14	400-00
691/3	250	B 24	B 19	400-00
691/4	500	B 24	B 14	600-00
691/5	500	B 24	B 19	600-00
691/6	500	B 34	B 24	710-00
691/7	1000	B 24	B 14	830-00
691/8	1000	B 24	B 19	830-00
691/9	1000	B 34	B 19	830-00
691/10	2000	B 24	B 19	1535-00
691/11	2000	B 34	B 19	1535-00
691/12	2000	B 34	B 24	1535-00
691/13	3000	B 34	B 19	3150-00
691/14	3000	B 34	B 24	3150-00
691/15	5000	B 34	B 19	4350-00
691/16	5000	B 40	B 19	4350-00
691/17	5000	B 50	B 19	4350-00
691/18	5000	B 55	B 19	4350-00
691/19	5000	B 34	B 24	4350-00
691/20	5000	B 40	B 24	4350-00
691/21	5000	B 50	B 24	4350-00
691/22	5000	B 55	B 24	4350-00
691/23	10000	B 34	B 19	7400-00
691/24	10000	B 40	B 19	7400-00
691/25	10000	B 50	B 19	7400-00
691/26	10000	B 55	B 19	7400-00
691/27	10000	B 34	B 24	7400-00
691/28	10000	B 50	B 24	7400-00
691/29	10000	B 55	B 24	7400-00
691/30	20000	B 34	B 19	13900-00
691/31	20000	B 50	B 19	13900-00
691/32	20000	B 55	B 19	13900-00
691/33	20000	B 34	B 19	13900-00
691/34	20000	B 34	B 24	13900-00
691/35	20000	B 50	B 24	13900-00
691/36	20000	B 55	B 24	13900-00

Note:- While Ordering, do mention necks at Flask required angle or at Parallel.

691A. Flask Round Bottom, Four neck "LABCO", side neck, either angled or parallel.

Cat. No.	Capacity ml.	Centre Socket	Side Sockets	Price/Piece Rs.
691A/1	100	B 24	B 14	475-00
691A/2	100	B 24	B 19	475-00
691A/3	250	B 24	B 14	625-00
691A/4	250	B 24	B 19	625-00
691A/5	500	B 24	B 14	900-00
691A/6	500	B 24	B 19	900-00
691A/7	500	B 24	B 24	900-00
691A/8	500	B 34	B 24	900-00
691A/9	1000	B 24	B 14	1125-00
691A/10	1000	B 24	B 19	1125-00
691A/11	1000	B 24	B 24	1125-00
691A/12	1000	B 34	B 24	1125-00
691A/13	2000	B 24	B 14	1880-00
691A/14	2000	B 24	B 19	1880-00
691A/15	2000	B 34	B 19	1880-00
691A/16	2000	B 34	B 24	1880-00
691A/17	3000	B 34	B 19	3475-00
691A/18	3000	B 34	B 24	3475-00
691A/19	5000	B 34	B 19	4950-00
691A/20	5000	B 34	B 24	4950-00
691A/21	10000	B 55	B 24	9550-00
691A/22	20000	B 55	B 24	14400-00

Note:- While Ordering, do mention necks at Flask required angle or at Parallel.

691B Glass Sampler Boro 3.3 Exp. Glass, 1 meter long made from heavy 19 tube tapered from both ends. 575-00

Note : Rs. 125-00 Ea. will be charged extra for printing any chemical/ solvent name in above glass sampler.

691C Dissolution Vessels 'LABCO'

Cat. No.	Capacity	Price/Piece Rs.
691C/1	1000ml.	2150-00
691C/2	2000ml.	2600-00

691M Dissolution Vessels Amber Coloured 'LABCO'

Cat. No.	Capacity	Price/Piece Rs.
691M/1	1000ml.	3400-00
691M/2	2000ml.	3900-00

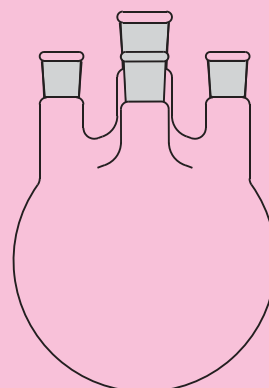

691A

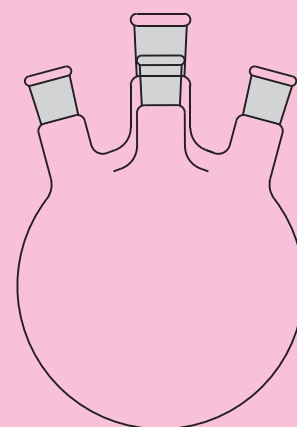

691A

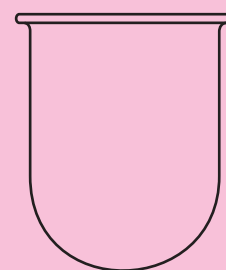

691C

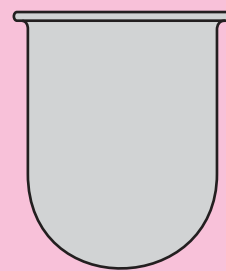

691M

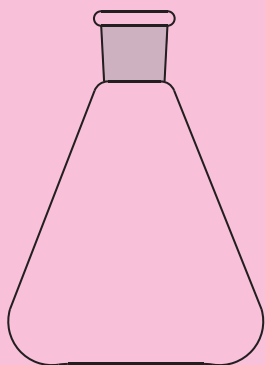

692

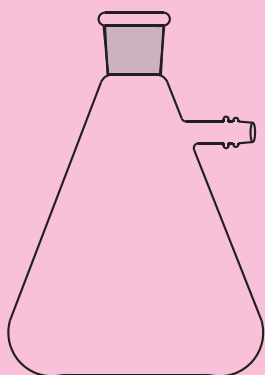

693

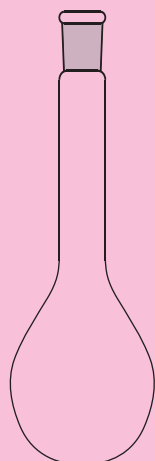

694

692. Flask Conical, "LABCO", Erlenmeyer.

Cat. No.	SocketCapacity ml.	Price/Piece	
		Rs.	
692/1	B 14	25	130-00
692/2	B-19	25	130-00
692/3	B 14	50	135-00
692/4	B 19	50	135-00
692/5	B 19	100	170-00
692/6	B 24	100	170-00
692/7	B 19	150	180-00
692/8	B 24	150	180-00
692/9	B 19	250	195-00
692/10	B 24	250	195-00
692/11	B 29	250	195-00
692/12	B 34	250	240-00
692/13	B 19	500	280-00
692/14	B 24	500	280-00
692/15	B 29	500	285-00
692/16	B 34	500	295-00
692/17	B 24	1000	545-00
692/18	B 29	1000	545-00
692/19	B 34	1000	545-00
692/20	B 24	2000	1075-00
692/21	B 34	2000	1075-00

693. Flasks Buchner, "LABCO", Filtration.

Cat. No.	SocketCapacity ml.	Price/Piece	
		Rs.	
693/1	B 19	100	285-00
693/2	B 24	250	500-00
693/3	B 24	500	600-00
693/4	B 24	1000	1020-00
693/5	B 34	1000	1040-00
693/6	B 34	2000	1925-00

694. Flasks Kjeldhal "LABCO".

Cat. No.	SocketCapacity ml.	Price/Piece	
		Rs.	
694/1	B 19	50	200-00
694/2	B 19	100	235-00
694/3	B 24	100	235-00
694/4	B 24	300	340-00
694/5	B 24	500	580-00
694/6	B 24	800	675-00
694/7	B 29	800	675-00

694A Flask Boiling, Pear Shape "LABCO", Suitable for Rotary Vacuum Evaporator with interchangeable socket

Cat. No.	Capacity ml.	Socket Size	Minimum Qty./Pack	Price/Piece Rs.
694A/1	50	B 24	2	285-00
694A/2	100	B 24	2	360-00
694A/3	300	B 24	2	560-00
694A/4	500	B 24	2	630-00
694A/5	800	B 24	2	925-00
694A/6	1000	B 24	2	1050-00
694A/7	2000	B 24	2	2300-00
694A/8	50	B 29	2	350-00
694A/9	100	B 29	2	445-00
694A/10	300	B 29	2	595-00
694A/11	500	B 29	2	770-00
694A/12	800	B 29	2	1050-00
694A/13	1000	B 29	2	1200-00
694A/14	2000	B 29	2	2500-00

694B Splash Head Adapters, "LABCO", for Rotavaps Anticlamp without return hole.

Cat. No.	Bulb Cap. ml.	Socket Size	Cone Size	Price/Piece Rs.
694B/1	100	B 29	B 14	465-00
694B/2	100	B 29	B 19	465-00
694B/3	100	B 29	B 24	465-00
694B/4	250	B 29	B 14	620-00
694B/5	250	B 29	B 19	620-00
694B/6	250	B 29	B 24	620-00
694B/7	500	B 29	B 14	875-00
694B/8	500	B 29	B 19	875-00
694B/9	500	B 29	B 24	875-00

695. Flasks Pear Shaped, "LABCO", Single neck.

Cat. No.	Socket Capacity ml.	Price/Piece Rs.
695/1	B 10	5 99-00
695/2	B 10/B 14	10 108-00
695/3	B 10/B 14	25 130-00
695/4	B 14/B 19	50 178-00
695/5	B 14/B 19/B 24	100 250-00

Note:- While Ordering, do mention size of Socket required.

696. Flasks Pear Shaped, "LABCO", Two necks, side neck at angle.

Cat. No.	Centre Neck	Side Neck	Capacity ml.	Price/Piece Rs.
696/1	B 14	B 14	25	220-00
696/2	B 14	B 14	50	285-00
696/3	B 14	B 14	100	310-00

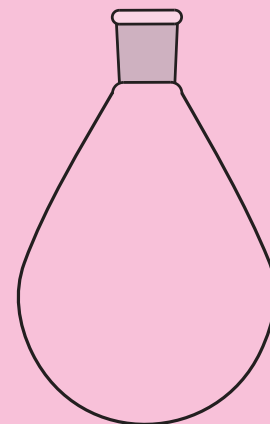

694A

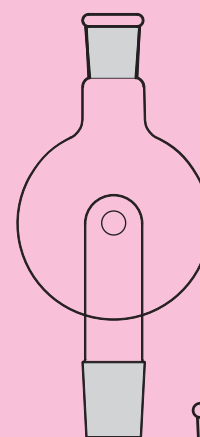

694B

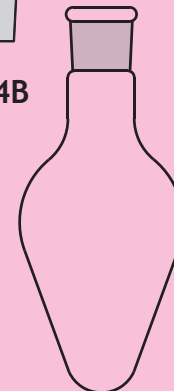

695

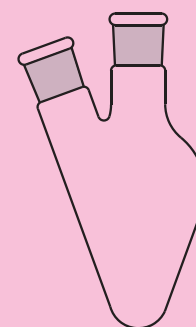

696

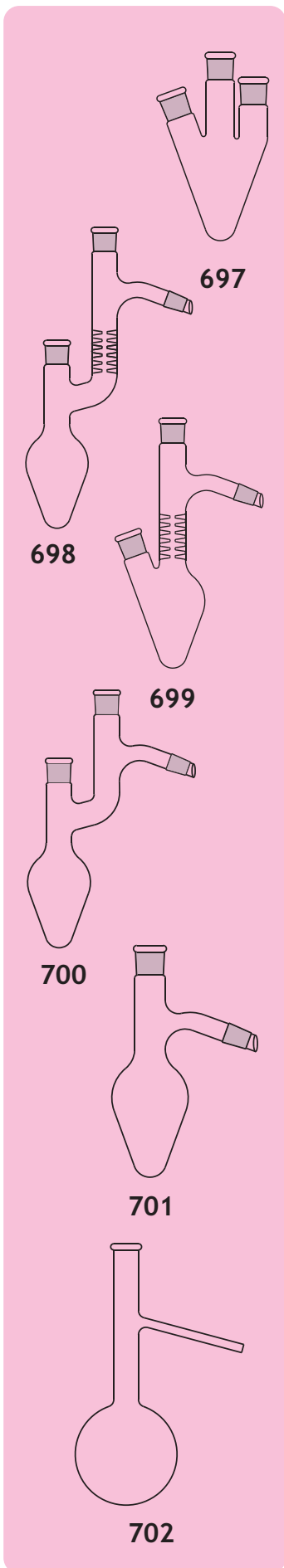

697. Flasks Pear Shaped, "LABCO", Three necks one side neck at angle and other neck parallel.

Cat. No.	Socket	Cone	Capacity ml.	Price/Piece Rs.
697/1	B 14	B 14	25	340-00
697/2	B 14	B 14	50	360-00
697/3	B 14	B 14	100	385-00

698. Flasks Vigreux, "LABCO", Claisen Type.

Cat. No.	Socket	Cone	Capacity ml.	Price/Piece Rs.
698/1	B 14	B 14	10	360-00
698/2	B 14	B 14	25	370-00
698/3	B 14	B 14	50	370-00
698/4	B 14	B 14	100	490-00

699. Flasks Vigreux, "LABCO", with side neck.

Cat. No.	Socket	Cone	Capacity ml.	Price/Piece Rs.
699/1	B 14	B 14	10	360-00
699/2	B 14	B 14	25	370-00
699/3	B 14	B 14	50	370-00
699/4	B 14	B 14	100	490-00

700. Flasks Claisen Pear Shaped, "LABCO".

Cat. No.	Socket	Cone	Capacity ml.	Price/Piece Rs.
700/1	B 14	B 14	10	320-00
700/2	B 14	B 14	25	340-00
700/3	B 14	B 14	50	360-00
700/4	B 14	B 14	100	440-00

701. Flasks Distillation Pear Shaped, "LABCO".

Cat. No.	Socket	Cone	Capacity ml.	Price/Piece Rs.
701/1	B 14	B 14	10	180-00
701/2	B 14	B 14	25	220-00
701/3	B 14	B 14	50	280-00
701/4	B 14	B 14	100	325-00

702. Flasks Distillation, "LABCO", with side Tube.

Cat. No.	Capacity ml.	Price/Piece Rs.
702/1	25	135-00
702/2	50	150-00
702/3	100 or 125	220-00
702/4	250	265-00
702/5	500	315-00
702/6	1000	475-00

Note : Flasks above 250 ml. will be of short neck.

703. Flasks Buchner, "LABCO", Filtration Bolt Neck.

Cat. No.	Capacity ml.	Price/Piece Rs.
703/1	50	170-00
703/2	100	230-00
703/3	250	410-00
703/4	500	510-00
703/5	1000	885-00
703/6	2000	1500-00
703/7	5000	5250-00
703/8	10000	9450-00
703/9	20000	15900-00

Note: The flasks in Cat. No. 703 are made from Heavy Wall and suitable for High Vacuum.

704. Flasks Conical, "LABCO", with Teflon liner Screw Cap.

Cat. No.	Capacity ml. Qty./Pack	Min. Rs.	Price/Piece Rs.
704/1	25	2	140-00
704/2	50	2	165-00
704/3	100	2	200-00
704/4	150	2	230-00
704/5	250	2	260-00
704/6	500	2	340-00
704/7	1000	2	580-00
704/8	2000	2	1190-00
704/9	5000	2	3675-00

705. Flasks Conical, "LABCO", with interchangeable stopper.

Cat. No.	Capacity ml.	Socket Size	Min. Qty./Pack	Price/Piece Rs.
705/1	25	B 14	12	160-00
705/2	50	B 19	12	180-00
705/3	100	B 24	12	230-00
705/4	100	B 19	12	230-00
705/5	100	B 29	12	230-00
705/6	150	B 24	12	250-00
705/7	250	B 24	12	265-00
705/8	250	B 29	12	265-00
705/9	500	B 24	12	365-00
705/10	1000	B 24	12	565-00
705/11	2000	B 34	6	1190-00

705M Amber Colour Flasks Conical, "LABCO", with interchangeable stopper.

Cat. No.	Capacity ml.	Socket Size	Min. Qty./Pack	Price/Piece Rs.
705M/1	25	B 14	12	235-00
705M/2	50	B 19	12	255-00
705M/3	100	B 24	12	325-00
705M/4	100	B 29	12	325-00
705M/5	150	B 24	12	355-00
705M/6	250	B 24	12	410-00
705M/7	250	B 29	12	410-00
705M/8	500	B 24	12	575-00
705M/9	1000	B 24	12	1050-00
705M/10	2000	B 34	6	1800-00

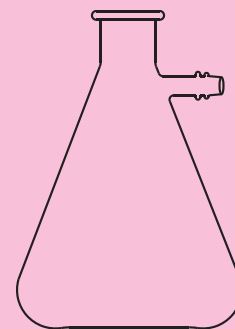

703

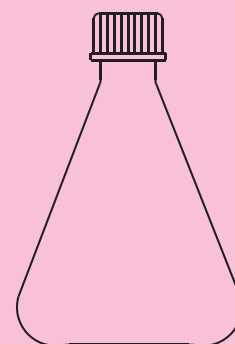

704

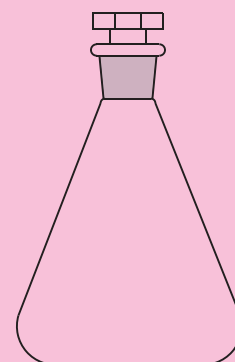

705

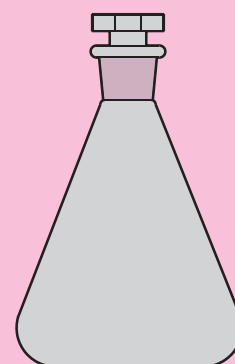

705M

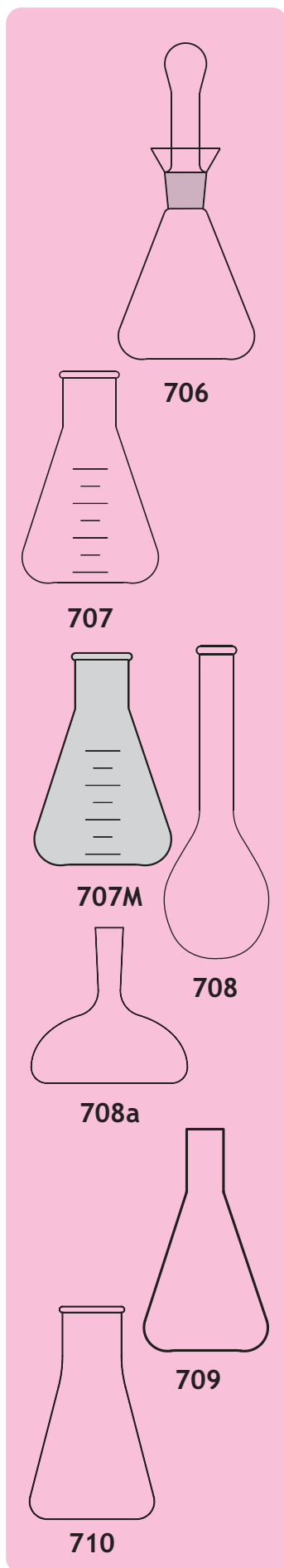

706 Iodine Flasks, "LABCO", with Flaring, Funnel Shaped Cup.

Cat. No.	Capacity ml. Qty./Pack	Min. Rs.	Price/Piece
706/1	100	12	200-00
706/2	250	12	245-00
706/3	500	12	310-00
706/4	1000	12	695-00

707 Flasks Erlenmeyer's, "LABCO", Conical Graduated Approx.

Cat. No.	Capacity ml.	Graduation Interval (ml.)	Mln. Qty./Pack	Price/Piece Rs.
707/1	5	--	12	44-00
707/2	10	--	12	45-00
707/3	25	--	12	68-00
707/4	50	--	12	72-00
707/5	100	25	12	75-00
707/6	150	25	12	95-00
707/7	250	50	12	120-00
707/8	500	100	12	172-00
707/9	1000	200	12	295-00
707/10	2000	500	6	890-00
707/11	3000	500	6	1375-00
707/12	5000	500	2	2275-00

707M Amber Colour Flask Erlenmeyer's, "LABCO", Conical Graduated Approx.

Cat. No.	Capacity ml. Qty./Pack	Min. Rs.	Price/Piece
707M/1	50	12	150-00
707M/2	100	12	165-00
707M/3	250	12	230-00
707M/4	500	12	370-00
707M/5	1000	4	685-00
707M/6	2000	4	1350-00

708 Flasks Kjeldhal, "LABCO", Round Bottom, long neck.

Cat. No.	Capacity ml.	Price/Piece Rs.
708/1	10	78-00
708/2	30	102-00
708/3	50	158-00
708/4	100	172-00
708/5	300	278-00
708/6	500	465-00
708/7	800	585-00

708a Flasks Culture, Haffkine, "LABCO",

Cat No.	Capacity (ml.)	OD X HT (mm) Rs.	Price/Piece
708a/1	3000	241 x 273	2550-00
708a/2	4000	241 x 310	2975-00

**709 Flask Erlenmeyer "LABCO", Conical Long neck without rim
Cap-250 ml. OD x Ht. 78 x 154 mm Neck 25 mm**

155-00

710 Flask Erlenmeyer "LABCO", Conical wide mouth

Cat No.	Cap. ml.	OD x Ht. mm.	Neck mm.	Price/Piece Rs.
710/1	100	70 x 110	34	88-00
710/2	250	74 x 134	36	128-00
710/3	500	97 x 170	47	198-00
710/4	1000	120 x 220	56	350-00

710A Cleaning Brushes for Flasks, made of Nylon Bristle (Pack of 6pcs) **355-00**

711 Flask Conical "LABCO", without rim

Cat No.	Cap. ml.	OD x Ht. mm.	Neck mm.	Price/Piece Rs.
711/1	750	114 x 210	34	380-00

711A Boiling Flasks, "LABCO", Round/Flat bottom.

Cat. No.	Capacity ml. Qty./Pack	Min. Rs.	Price/Piece
711A/1	5	24	66-00
711A/2	10	24	66-00
711A/3	20	24	72-00
711A/4	25	24	72-00
711A/5	50	24	88-00
711A/6	100	24	102-00
711A/7	150	24	105-00
711A/8	250	12	110-00
711A/9	500	12	190-00
711A/10	1000	12	320-00
711A/11	2000	6	940-00
711A/12	3000	6	1525-00
711A/13	5000	2	2475-00
711A/14	10000	1	5100-00
711A/15	20000	1	9400-00

Note : While Ordering, do mention flask required Round or Flat Bottom.

711M Amber Colour Boiling Flasks, "LABCO", Round/Flat bottom.

Cat. No.	Capacity ml. Qty./Pack	Min. Rs.	Price/Piece
711M/1	50	12	265-00
711M/2	100	12	390-00
711M/3	250	12	410-00
711M/4	500	12	660-00
711M/5	1000	4	875-00
711M/6	2000	4	1350-00

Note : While Ordering, do mention flask required Round or Flat Bottom.

712 Drying tray "LABCO", Ovenproof, for drying purpose, heavy type. Square shape or rectangular shape **1950-00**

713 Evaporating basins "LABCO", Flat bottom, with pour out

Size	80 x 45	105 x 55	150 x 80	200 x 100
Rate	255-00	350-00	840-00	1660-00

714 Dishes, Crystallizing, "LABCO", Heavy type

Cap.	20ml	40ml	60ml	100ml	150ml
Rates	110-00	125-00	160-00	185-00	250-00
Cap	300ml	500ml	1000ml	2000ml	
Rate	350-00	675-00	840-00	1340-00	



710A



711

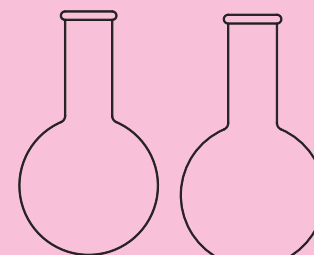

711A

711A

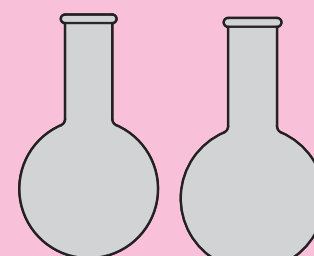

711M

711M

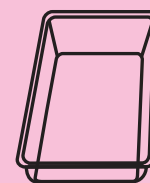

712



713



714

STANDARD JOINTS, STOPPERS, ADAPTERS

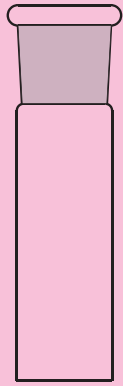

715

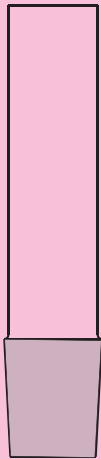

716

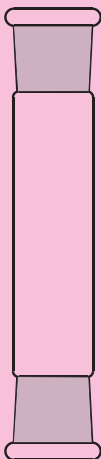

717

715. Sockets, "LABCO", Plain Shank, Single.

Cat. No.	Socket	Min. Qty./Pack	Price/Piece	
			Rs.	
715/1	B 7	12	65-00	
715/2	B 10	12	65-00	
715/3	B 12	12	65-00	
715/4	B 14	12	65-00	
715/5	B 19	12	70-00	
715/6	B 24	12	92-00	
715/7	B 29	12	118-00	
715/8	B 34	12	138-00	
715/9	B 40	12	210-00	
715/10	B 45	12	245-00	
715/11	B 50	12	300-00	
715/12	B 55	12	410-00	

Note : Socket with Hooks, 10% extra.

716. Cones, "LABCO", Plain End, Single.

Cat. No.	Socket	Min. Qty./Pack	Price/Piece	
			Rs.	
716/1	B 7	12	65-00	
716/2	B 10	12	65-00	
716/3	B 12	12	65-00	
716/4	B 14	12	65-00	
716/5	B 19	12	70-00	
716/6	B 24	12	92-00	
716/7	B 29	12	118-00	
716/8	B 34	12	138-00	
716/9	B 40	12	210-00	
716/10	B 45	12	245-00	
716/11	B 50	12	300-00	
716/12	B 55	12	410-00	

Note : Cone with Drip, 10% extra.

717. Sockets, "LABCO", Plain Shank Double.

Cat. No.	Socket	Shank	Min. Qty./Pack	Price/Piece	
		length mm.		Rs.	
717/1	B 7	80	12	120-00	
717/2	B 10	80	12	120-00	
717/3	B 14	80	12	120-00	
717/4	B 19	80	12	130-00	
717/5	B 24	80	12	160-00	
717/6	B 29	90	12	200-00	
717/7	B 34	100	12	240-00	
717/8	B 40	110	12	360-00	

Note: Sockets with Hooks, 10% extra.

718. Cones, "LABCO", Plain End Double.

Cat. No.	Cone	Shank length mm.	Min. Qty./Pack	Price/Piece Rs.
718/1	B 7-	80	12	120-00
718/2	B 10	80	12	120-00
718/3	B 14	80	12	120-00
718/4	B 19	80	12	130-00
718/5	B 24	80	12	160-00
718/6	B 29	90	12	200-00
718/7	B 34	100	12	240-00
718/8	B 40	110	12	360-00

Note : Cones with tip, 10% extra.

718a Grip Clamps, "LABCO", to hold Interchangeable Standard Joints.

Cat. No. Qty./Pack	Cone Min. Rs.	Price/Piece	Size
718a/1	B-14	10	14-00
718a/2	B-19	10	18-00
718a/3	B-24	10	24-00
718a/4	B-29	10	28-00
718a/5	B-34	10	38-00
718a/6	B 40	10	68-00

719. Spherical Joints, Ball and Cup, "LABCO",

Cat. No.	Joint	Approx. Bore mm.	Price/Piece Rs.	Clip Price Rs.
719/1	S 13	2	225-00	155-00
719/2	S 13	5	225-00	155-00
719/3	S 19	9	240-00	185-00
719/4	S 29	15	325-00	200-00
719/5	S 35	21	440-00	225-00
719/6	S 41	32	1090-00	490-00

719a Polypropylene Stoppers, interchangeable "LABCO", Hexagonal Heads

Cat. No. Qty./Pack	Cone Min. Rs.	Price/Piece	Size
719a/1	B-10	50	9-00
719a/2	B-14	50	13-50
719a/3	B-19	50	15-00
719a/4	B-24	50	24-00
719a/5	B-29	50	34-00
719a/6	B 34	50	44-00

720. Stoppers, "LABCO", Hollow.

Cat. No.	ShapeCone	Price/Piece Rs.
720/1	Hexagonal	B 10
720/2		B 12 or B 14
720/3		B 19
720/4		B 24
720/5		B 29
720/6		B 34
720/7	Penny Head	B 40
720/8		B 45
720/9		B 50
720/10		B 55

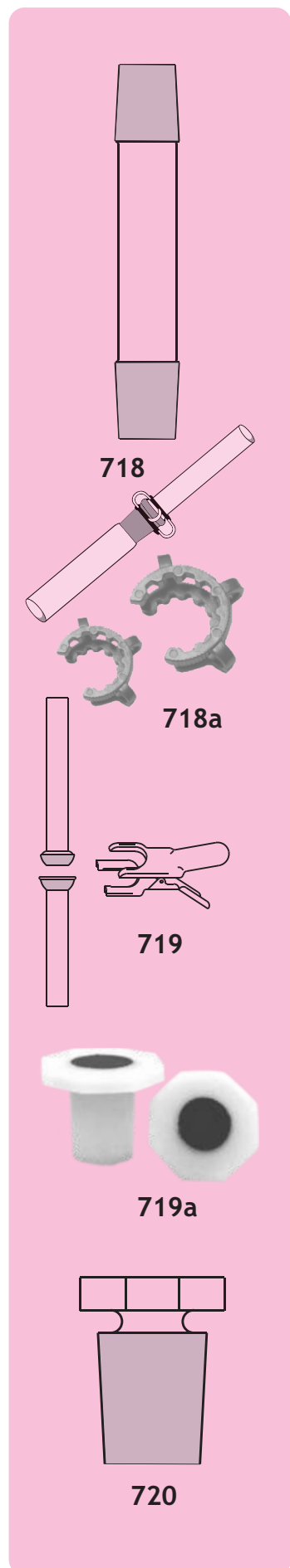

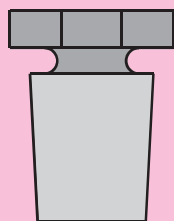

720M



721



722

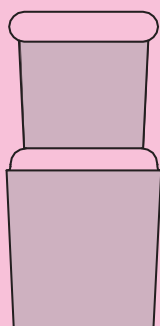

723

720M Amber Colour Stoppers, "LABCO", Hollow

Cat. No. Qty./Pack	Cone Min. Rs.	Price/Piece	Size
720M/1	B-10	50	44-00
720M/2	B-14	50	45-00
720M/3	B-19	25	54-00
720M/4	B-24	25	63-00
720M/5	B-34	10	125-00

721. Stoppers, "LABCO", Solid, Penny or Flat Head.

Cat. No.	Cone	Price/Piece Rs.
721/1	B 10	33-00
721/2	B 14	40-00
721/3	B 19	63-00
721/4	B 24	82-00
721/5	B 29	135-00
721/6	B 34	230-00

722. Stoppers, Interchangeable, Ground Joint for Volumetric Flask "LABCO"

Cat. No.	Cone Size	Capacity For	Min. Qty./Pack	Price/Piece Rs.
722/1	B 10	Volumetric Flask 5ml, 10ml, 20ml	50	33-00
722/2	B 10	Volumetric Flask 25ml, 50ml	50	33-00
722/3	B 14	Volumetric Flask 100ml, 200ml, 250ml	50	40-00
722/4	B 19	Volumetric Flask 500ml, 1000ml	25	63-00
722/5	B 24	Volumetric Flask 2000ml	25	82-00

723. Reduction Adapters, "LABCO".

Cat. No.	SocketCone	Price/Piece Rs.
723/1	B 14 B 19	88-00
723/2	B 14 B 24	100-00
723/3	B 14 B 29	133-00
723/4	B 19 B 24	108-00
723/5	B 19 B 29	130-00
723/6	B 19 B 34	160-00
723/7	B 19 B 40	195-00
723/8	B 19 B 45	205-00
723/9	B 19 B 55	300-00
723/10	B 24 B 29	140-00
723/11	B 24 B 34	160-00
723/12	B 24 B 40	195-00
723/13	B 24 B 45	210-00
723/14	B 24 B 50	250-00
723/15	B 24 B 55	300-00
723/16	B 29 B 34	185-00
723/17	B 29 B 40	210-00
723/18	B 34 B 40	230-00
723/19	B 34 B 50	285-00
723/20	B 34 B 55	330-00
723/21	B 40 B 55	400-00

724. Expansion Adapters, "LABCO".

Cat. No.	SocketCone	Price/Piece Rs.	
724/1	B 19	B 14	102-00
724/2	B 24	B 14	138-00
724/3	B 24	B 19	128-00
724/4	B 29	B 19	152-00
724/5	B 29	B 24	158-00
724/6	B 34	B 19	180-00
724/7	B 34	B 24	190-00
724/8	B 34	B 29	200-00
724/9	B 40	B 24	235-00

Note : Reduction and Expansion adapters of any other size can also be supplied.

725. Conical Spherical Adapters, "LABCO", with Clip. Rates on request.

726. Multiple Adapters, "LABCO", with Two Necks Parallel.

Cat. No.	SocketCone	Price/Piece Rs.	
726/1	B 14	B 14	200-00
726/2	B 19	B 19	235-00
726/3	B 19	B 24	240-00
726/4	B 24	B 24	285-00
726/5	B 19	B 34	320-00
726/6	B 29	B 29	375-00

727. Multiple Adapters, "LABCO", with Two Necks at 45°.

Cat. No.	SocketCone	Price/Piece Rs.	
727/1	B 19	B 19	235-00
727/2	B 19	B 24	240-00
727/3	B 19	B 34	315-00

728. Multiple Adapters, "LABCO", with Three Necks, Two Parallel and one at 45°.

Cat. No.	SocketCone	Price/Piece Rs.	
728/1	B 19	B 24	340-00
728/2	B 19	B 29	385-00
728/3	B 19	B 34	400-00
728/4	B 19	B 45	575-00
728/5	B 19	B 55	660-00

729. Swan Neck Adapters, "LABCO".

Cat. No.	SocketCone	Price/Piece Rs.	
729/1	B 19	B 19	175-00
729/2	B 19	B 24	175-00
729/3	B 24	B 24	190-00
729/4	B 24	B 34	210-00

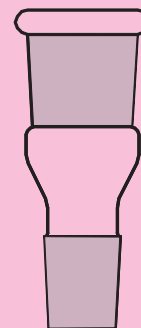

724

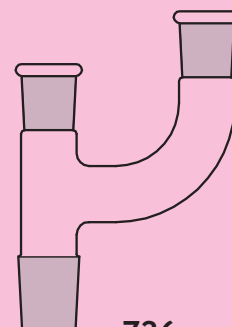

726

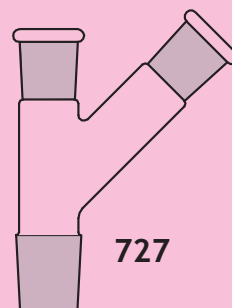

727

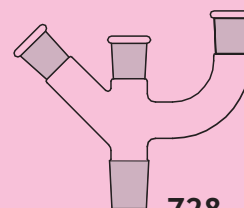

728

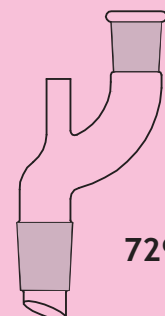

729

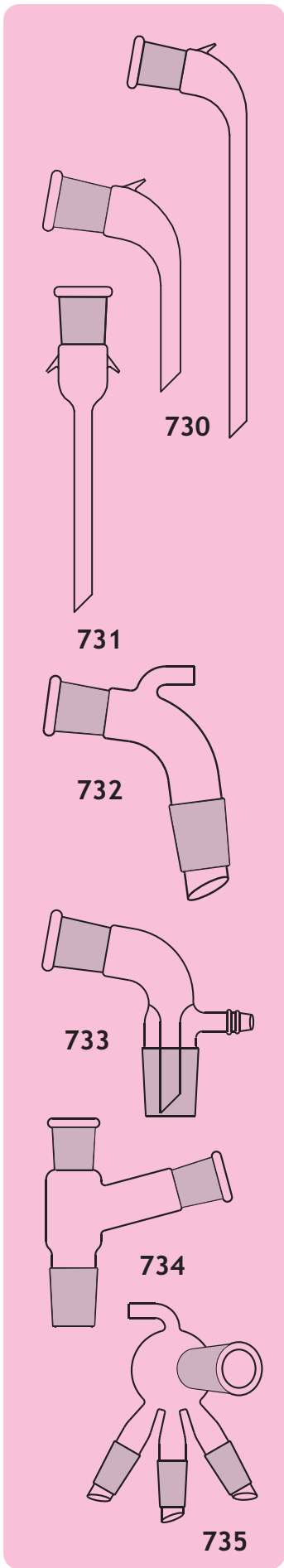

730. Receiver Adapters, "LABCO", Plain Bend Short/long.

Cat. No.	Socket	Price/Piece Rs.
730/1	B 14	95-00
730/2	B 19	110-00
730/3	B 24	130-00
730/4	B 29	150-00
730/5	B 34	190-00
730/6	B 40	250-00
730/7	B 45	335-00
730/8	B 50	415-00
730/9	B 55	435-00

731. Straight Delivery Adapters, "LABCO".

Cat. No.	Socket	Price/Piece Rs.
731/1	B 14	98-00
731/2	B 19	112-00
731/3	B 24	130-00
731/4	B 34	190-00

732. Receiver Adapters, "LABCO", Bend with Vent.

Cat. No.	SocketCone	Price/Piece Rs.
732/1	B 14	B 14 185-00
732/2	B 19	B 19 200-00
732/3	B 19	B 24 210-00
732/4	B 24	B 24 250-00
732/5	B 34	B 34 370-00

733. Receiver Adapters, "LABCO", Bend or Straight with Vacuum connection.

Cat. No.	SocketCone	Price/Piece Rs.
733/1	B 14	B 14 190-00
733/2	B 19	B 19 200-00
733/3	B 19	B 24 210-00
733/4	B 24	B 24 245-00
733/5	B 24	B 34 300-00
733/6	B 34	B 34 350-00

734. Receiver Adapters, "LABCO", Bend with Socket Connections.

Cat. No.	SocketCone	Price/Piece Rs.
734/1	B 14	B 14 205-00
734/2	B 19	B 19 235-00
734/3	B 19	B 24 240-00

735. Receiver Adapters, "LABCO", Bend with Multiple Connections (Fig).

Cat. No.	SocketCone	Price/Piece Rs.
735/1	B 14	B 14 395-00
735/2	B 14	B 19 415-00
735/3	B 19	B 19 430-00

736. Perkin Intermediate Receiver, "LABCO".

Cat. No.	SocketCone	Price/Piece Rs.	
736/1	B 14	B 14	1275-00
736/2	B 19	B 19	1300-00
736/3	B 19	B 24	1300-00
736/4	B 24	B 24	1360-00
736/5	B 34	B 24	1525-00
736/6	B 34	B 34	1875-00

737. Receiver Adapters, Plain Bend, "LABCO".

Cat. No.	SocketCone	Price/Piece Rs.	
737/1	B 19	B 19	170-00
737/2	B 19	B 24	180-00
737/3	B 24	B 24	210-00
737/4	B 34	B 34	325-00

STILL HEADS/SPLASH HEADS

738. Still Heads, Recovery Bend, "LABCO", Sloping (Elbow).

Cat. No.	ConeCone fitting fitting flask	Price/Piece Condenser	Rs.
738/1	B 14	B 14	145-00
738/2	B 24	B 14	195-00
738/3	B 19	B 19	165-00
738/4	B 24	B 19	200-00
738/5	B 29	B 19	225-00
738/6	B 34	B 19	265-00
738/7	B 24	B 24	195-00
738/8	B 34	B 24	250-00
738/9	B 55	B 24	510-00
738/10	B 34	B 34	325-00

739. Still Heads, Recovery Bend, "LABCO", Vertical.

Cat. No.	ConeCone fitting fitting flask	Price/Piece Condenser	Rs.
739/1	B 14	B 14	175-00
739/2	B 19	B 19	210-00
739/3	B 24	B 14	245-00
739/4	B 24	B 24	275-00
739/5	B 34	B 34	410-00

740. Recovery Head, "LABCO", Sloping with B 14 Socket.

Cat. No.	ConeCone fitting fitting flask	Price/Piece Condenser	Rs.
740/1	B 14	B 14	210-00
740/2	B 19	B 19	245-00
740/3	B 24	B 19	250-00
740/4	B 29	B 19	275-00
740/5	B 34	B 19	310-00
740/6	B 24	B 24	260-00
740/7	B 34	B 24	425-00
740/8	B 55	B 24	530-00
740/9	B 34	B 34	440-00
740/10	B 55	B 34	585-00

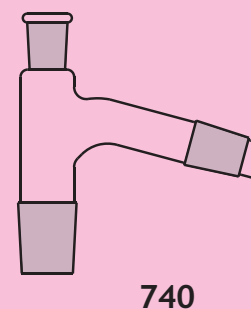
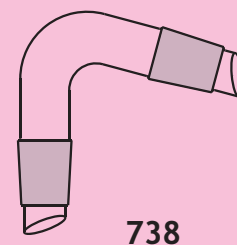
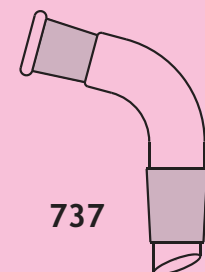
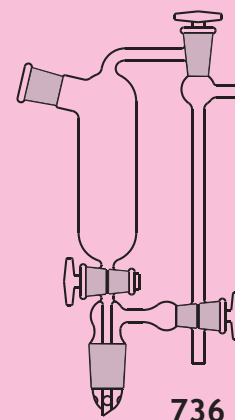

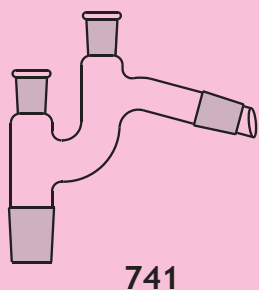

741. Claisen Heads, "LABCO", Sloping with 2 x B-14 Sockets.

Cat. No.	Cone fitting		Price/Piece
	fitting flask	Condenser	
741/1	B 14	B 19	300-00
741/2	B 19	B 19	335-00
741/3	B 24	B 19	350-00
741/4	B 34	B 19	425-00
741/5	B 24	B 24	390-00
741/6	B 34	B 24	430-00

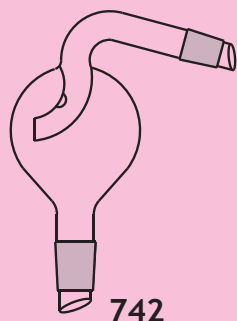

742. Splash Heads, "LABCO", Pear Shape Sloping.

Cat. No.	Cone fitting		Price/Piece
	fitting flask	Condenser	
742/1	B 19	B 19	325-00
742/2	B 24	B 19	340-00
742/3	B 34	B 19	430-00
742/4	B 34	B 24	435-00
742/5	B 34	B 34	475-00
742/6	B 24	B 24	350-00

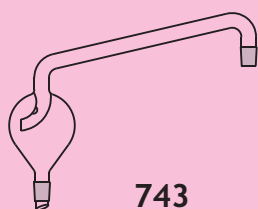

743. Splash Heads, "LABCO", Pear Shape Vertical.

Cat. No.	Cone fitting		Price/Piece
	fitting flask	Condenser	
743/1	B 19	B 19	370-00
743/2	B 24	B 19	380-00
743/3	B 34	B 19	480-00
743/4	B 24	B 24	400-00
743/5	B 34	B 24	515-00



744. Splash Head Adapter, "LABCO".

Cat. No.	Cone fitting		Price/Piece
	fitting flask	Condenser	
744/1	B 24	B 19	320-00

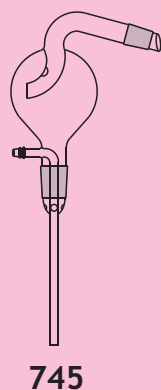

745. Steam Distillation Heads, "LABCO", Pear Shape Sloping.

Cat. No.	Cone fitting	Cone fitting	Price/Piece
	flask	Condenser	
745/1	B 24	B 19	410-00
745/2	B 34	B 19	430-00
745/3	B 34	B 24	440-00

MISCELLANEOUS FITTING

746. Adapters, "LABCO", Cone to Rubber Tubing, Straight connection, with Stopcock.

Cat. No.	Cone	Price/Piece Rs.
746/1	B 14	240-00
746/2	B 19	245-00
746/3	B 24	250-00
746/4	B 34	340-00

746a. Adapters, "LABCO", Cone to Rubber Tubing, Right angle connection.

Cat. No.	Cone	Price/Piece Rs.
746a/1	B 14	240-00
746a/2	B 19	245-00
746a/3	B 24	250-00
746a/4	B 34	340-00

747. Adapters, "LABCO", Socket to Rubber Tubing Straight or Right angle connection, with Stopcock.

Cat. No.	Socket	Price/Piece Rs.
747/1	B 14	250-00
747/2	B 19	255-00
747/3	B 24	265-00

748. Adapters, "LABCO", Cone to rubber tubing, straight connection.

Cat. No.	Cone	Price/Piece Rs.
748/1	B 14	93-00
748/2	B 19	102-00
748/3	B 24	112-00
748/4	B 34	160-00

748a. Adapter "LABCO", Cone to rubber tubing, right angle connection.

Cat. No.	Cone	Price/Piece Rs.
748a/1	B 14	93-00
748a/2	B 19	102-00
748a/3	B 24	112-00
748a/4	B 34	160-00

749. Adapters, "LABCO", Cone with stem to rubber tubing right angle connection.

Cat. No.	Cone	Price/Piece Rs.
749/1	B 14	122-00
749/2	B 19	133-00
749/3	B 24	145-00

750. Adapter, "LABCO", Socket to Rubber tubing, Straight connection.

Cat. No.	Socket	Price/Piece Rs.
750/1	B 19	102-00
750/2	B 24	108-00

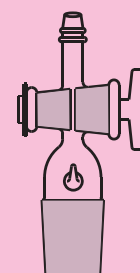

746

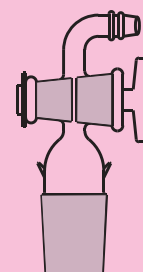

746a

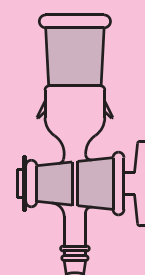

747

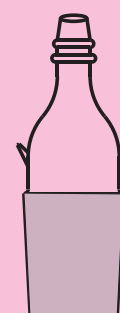

748

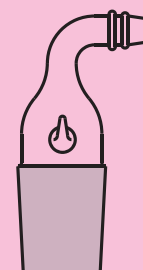

748a

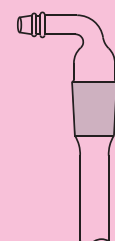

749

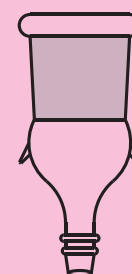

750

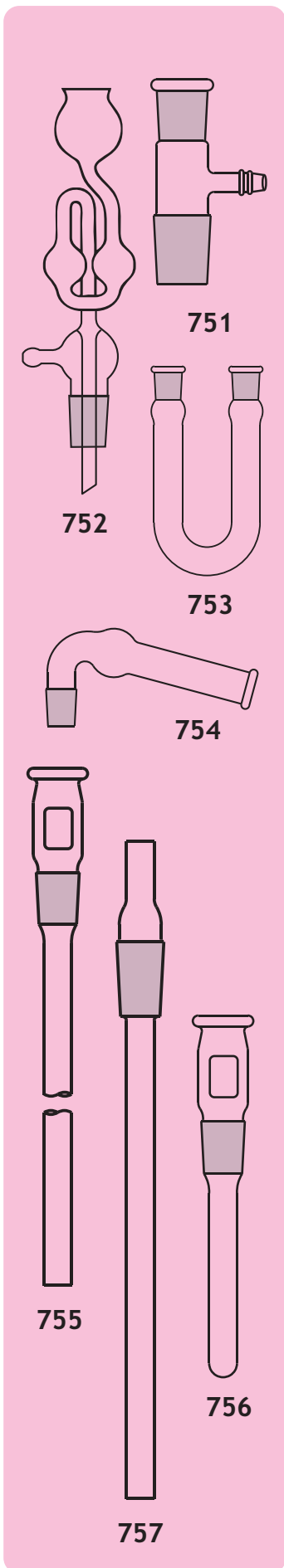

751. Adapters, "LABCO", Socket to cone with Tee Connection.

Cat. No.	Socket	Cone	Price/Piece Rs.
751/1	B 14	B 14	115-00
751/2	B 14	B 19	120-00
751/3	B 14	B 24	130-00
751/4	B 19	B 19	135-00
751/5	B 19	B 24	145-00
751/6	B 19	B 34	180-00
751/7	B 24	B 24	165-00
751/8	B 24	B 34	205-00
751/9	B 34	B 34	230-00

752. Thistle Funnel head, "LABCO", with B 24 cone 275-00

753. U Tube, "LABCO", with two sockets or cones.

Cat. No.	Cone	Price/Piece Rs.
753/1	B 14	240-00
753/2	B 19	275-00

754. Drying Tube, "LABCO".

Cat. No.	Cone	Price/Piece Rs.
754/1	B 14	108-00
754/2	B 19	130-00
754/3	B 24	145-00

755. Thermometer Pocket, "LABCO", Long type for sealing to length required.

Cat. No.	Cone	Price/Piece Rs.
755/1	B 14	108-00
755/2	B 19	128-00
755/3	B 24	145-00
755/4	B 34	215-00

756. Thermometer Pocket, "LABCO".

Cat. No.	Cone	Price/Piece Rs.
756/1	B 14	102-00
756/2	B 19	115-00
756/3	B 24	135-00
756/4	B 34	230.00

Note : While Ordering, do mention capacity of Flask for which Thermometer pocket is required.

757. Air Leak Tube/Gas Inlet Tube, "LABCO".

Cat. No.	Cone	Price/Piece Rs.
757/1	B 14	106-00
757/2	B 19	128-00
757/3	B 24	145-00
757/4	B 34	215-00

STIRRERS

760. Glass Stirring Rods, "LABCO".

Cat. No.	Approx. O.D. x Length (mm)	Min. Qty./Pack	Price/Piece Rs.
760/1	7 x 150	10	16-00
760/2	7 x 205	10	24-00
760/3	7 x 255	10	28-00
760/4	7 x 305	10	33-00
760/5	9 x 150	10	28-00
760/6	9 x 205	10	33-00
760/7	9 x 255	10	42-00
760/8	9 x 305	10	42-00
760/9	9 x 400	10	63-00

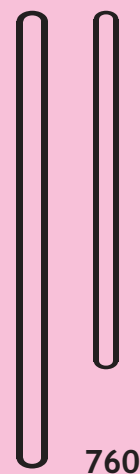

761. Teflon Bladed Stirrers, "LABCO", Removable from the Glass Rod Stirrer Shaft

Cat. No.	Approx. Shaft dia mm.	Shaft length mm.	Smallest Socket through which Stirrer will pass	Blade width mm.	Price/Piece Rs.
761/1	6	450	B 19	52	270-00
761/2	6	450	B 24	76	335-00
761/3	8	450	B 24	76	350-00
761/4	8	450	B 29	100	450-00
761/5	8	600	B 34	100	475-00
761/6	10	450	B 34	100	495-00
761/7	10	600	B 34	125	660-00
761/8	10	600	B 50	150	775-00

Spare Glass Shaft for Teflon Bladed stirrers, "LABCO".

761/9	6	450			120-00
761/10	8	450			135-00
761/11	8	600			155-00
761/12	10	450			170-00
761/13	10	600			210-00

761a Spare Teflon blade "LABCO", It can be easily replaceable & can easily be fitted.

Cat. No.	For Flask ml.mm.	Blade Width. Rs.	Price/Piece
761a/1	250 & 500	52	295-00
761a/2	1000	76	325-00
761a/3	2 Lit. & 3 Lit.	100	375-00
761a/4	5Lit. & 10Lit.	125	615-00
761a/5	20 Lit.	150	750-00

762 Link Stirrers, "LABCO".

762/1	6	450	B 24	75	200-00
762/2	6	600	B 24	75	220-00

763 Collapsible Paddle Stirrers, "LABCO".

763/1	6	600	B 24	75	295-00
-------	---	-----	------	----	--------

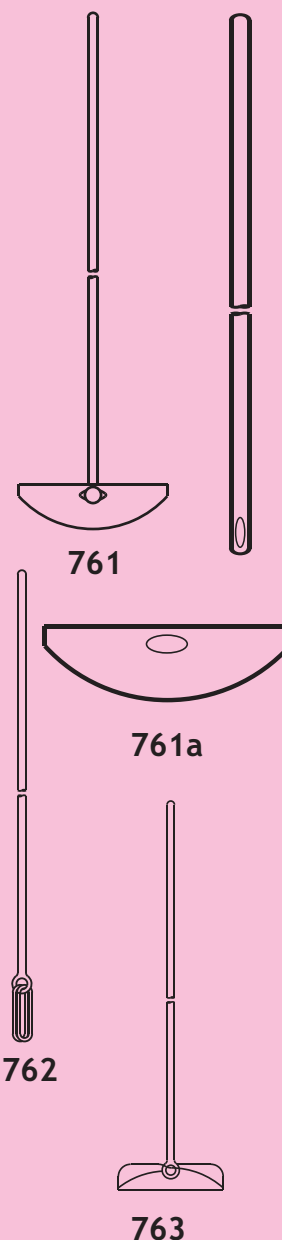

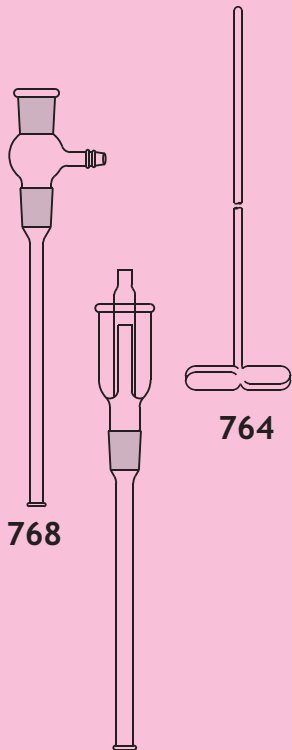

768

764

769

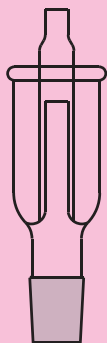

770

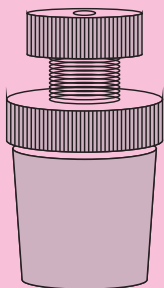

771

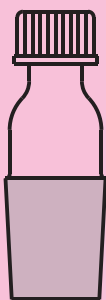

772

764 Fixed Paddle Stirrers, "LABCO".

Cat. No.	App. Shaft Dia mm	Shaft Length mm	Socket Through which blade will pass	Blade Width mm	Price/Piece Rs.
764/1	6	600	B 55	50	250-00
764/2	8	600	B 55	50	290-00
764/3	10	750	100 mm.	80	400-00

767. Semi Micro Stirrers, "LABCO".

Cat. No.	Type	Dia. mm.	Length mm.	Price/Piece Rs.
767/1	Screw	4	210	150-00
767/2	Anchor	4	210	150-00

768. Stirrers Guides, "LABCO".

Cat No.	To fit stirrer shaft	Socket	Cone	Approx. stem length	Price/Piece Rs.
768/1	6 mm	B 19	B 19	200 mm	280-00
768/2	10 mm	B 24	B 24	300 mm	290-00

769. Mercury Seal Glands and Guide, "LABCO".

Cat No.	To fit stirrer shaft	Cone	Approx. stem length	Price/Piece Rs.
769/1	6 mm	B 19	200 mm	330-00
769/2	6 mm	B 24	200 mm	340-00
769/3	8 mm	B 34	200 mm	420-00

770. Mercury Seal Glands and Cap, "LABCO".

Cat No.	To fit stirrer shaft	Cone	Price/Piece Rs.
770/1	6 mm	B 19	320-00
770/2	6 mm	B 24	330-00
770/3	8 mm	B 34	355-00
770/4	6 or 8 mm	B 24 with Teflon tube	780-00
770/5	6 or 8 mm	B 34 with Teflon tube	835-00

771 Stuffing Box Glands "LABCO", (P.T.F.E.) Teflon. (Gland only Without pulley).

Cat. No.	To fit shaft	Cone Stirrer	Price/Piece size Rs.
771/1	6-8 mm	B 19/B 24	1100-00
771/2	6-8 mm	B 34	1240-00
771/3	8-10 mm	B 40	2850-00
771/4	8-10 mm	B 50/B 55	4250-00

772. Simple Glands with Cap, "LABCO".

Cat No.	To fit stirrer shaft	Cone	Price/Piece Rs.
772/1	6 mm	B 14	90-00
772/2	6 mm	B 19	100-00
772/3	6 mm	B 24	110-00

SEPARATING / DROPPING FUNNELS

785. Separating Funnel, "LABCO", with Stopcock, Interchangeable Stopper, Conical/Pear Shape with Plain Stem.

Cat. No.	Capacity ml.Qty./Pack	Min. Rs.	Price/Piece
785/1	30	2	320-00
785/2	60	2	355-00
785/3	125	2	520-00
785/4	250	2	585-00
785/5	500	2	765-00
785/6	1000	2	1150-00
785/7	2000	2	2650-00

785M. Amber Colour Separating Funnel, "LABCO", with glass key Stopcock, Interchangeable Stopper, Conical/Pear Shape with Plain Stem.

Cat. No.	Capacity ml.Qty./Pack	Min. Rs.	Price/Piece
785M/1	30	4	540-00
785M/2	60	4	600-00
785M/3	125	4	715-00
785M/4	250	4	860-00
785M/5	500	4	1125-00
785M/6	1000	2	1650-00
785M/7	2000	2	3450-00

786. Separating Funnel, "LABCO", with Screw type, PTFE key, Rotaflow stopcock, Interchangeable Stopper, Conical/Pear Shape, Plain Stem.

Cat. No.	Capacity ml.Qty./Pack	Min. Rs.	Price/Piece
786/1	30	2	310-00
786/2	60	2	350-00
786/3	125	2	520-00
786/4	250	2	585-00
786/5	500	2	765-00
786/6	1000	2	1150-00
786/7	2000	2	2650-00

787. Separating Funnel, "LABCO", with PTFE key Stopcock, Interchangeable Stopper, Conical/Pear Shape, Plain Stem.

Cat. No.	Capacity ml.Qty./Pack	Min. Rs.	Price/Piece
787/1	30	2	600-00
787/2	60	2	610-00
787/3	125	2	760-00
787/4	250	2	840-00
787/5	500	2	1170-00
787/6	1000	2	1570-00
787/7	2000	2	3150-00



785

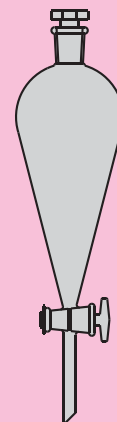

785M

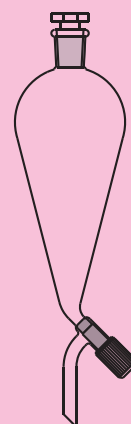

786



787

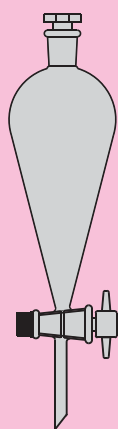

787M

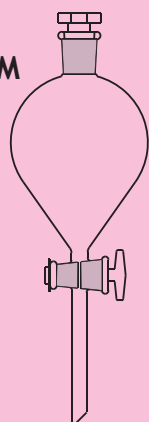

788

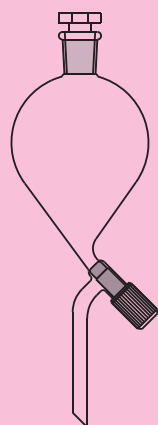

789

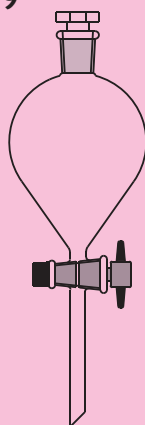

790

787M Amber Colour Separating Funnels, "LABCO", with PTFE key Stopcock, Interchangeable Stopper, Conical/Pear Shape, Plain Stem.

Cat. No.	Capacity ml.Qty./Pack	Min. Rs.	Price/Piece
787M/1	30	4	760-00
787M/2	60	4	825-00
787M/3	125	4	940-00
787M/4	250	4	1140-00
787M/5	500	4	1540-00
787M/6	1000	4	2150-00
787M/7	2000	2	4350-00

788. Separating Funnels, "LABCO", with Stopcock, Interchangeable Stopper, Globe Shape with Plain Stem.

Cat. No.	Capacity ml.Qty./Pack	Min. Rs.	Price/Piece
788/1	25	2	300-00
788/2	50	2	340-00
788/3	100	2	390-00
788/4	250	2	455-00
788/5	500	2	570-00
788/6	1000	2	940-00
788/7	2000	2	1925-00
788/8	3000	2	3150-00
788/9	5000	2	4470-00
788/10	10000	2	7800-00
788/11	20000	2	14900-00

789. Separating Funnels, "LABCO", with Screw type PTFE key, Rotaflow Stopcock, Interchangeable Stopper, Globe Shape, Plain Stem.

Cat. No.	Capacity ml.Qty./Pack	Min. Rs.	Price/Piece
789/1	25	2	290-00
789/2	50	2	320-00
789/3	100	2	375-00
789/4	250	2	500-00
789/5	500	2	600-00
789/6	1000	2	975-00
789/7	2000	2	1950-00

790. Separating Funnels, "LABCO", with PTFE key Stopcock, Interchangeable Stopper, Globe Shape, Plain Stem.

Cat. No.	Capacity ml.Qty./Pack	Min. Rs.	Price/Piece
790/1	25	2	570-00
790/2	50	2	600-00
790/3	100	2	650-00
790/4	250	2	790-00
790/5	500	2	1000-00
790/6	1000	2	1430-00
790/7	2000	2	2400-00
790/8	3000	2	6800-00
790/9	5000	2	8200-00
790/10	10000	2	17500-00
790/11	20000	2	24800-00

791. Dropping Funnels, "LABCO", Cylindrical with Interchangeable Stopper and Stopcock, Plain Stem.

Cat. No.	Capacity ml.	Price/Piece Rs.
791/1	50	320-00
791/2	100	360-00
791/3	150	385-00
791/4	250	450-00
791/5	500	620-00
791/6	1000	1100-00

792. Dropping Funnels, "LABCO", Cylindrical, Graduated, with Interchangeable Stopper and Stopcock, Plain Stem.

Cat. No.	Capacity ml.	Price/Piece Rs.
792/1	50	385-00
792/2	100	440-00
792/3	150	525-00
792/4	250	540-00
792/5	500	810-00
792/6	1000	1425-00

793. Dropping Funnels, "LABCO", Cylindrical with Screw type PTFE key Rotaflow Stopcock, Interchangeable Stopper and Stopcock, Plain Stem.

Cat. No.	Capacity ml.	Price/Piece Rs.
793/1	50	290-00
793/2	100	320-00
793/3	150	405-00
793/4	250	515-00
793/5	500	750-00
793/6	1000	1300-00

794. Dropping Funnels, "LABCO", Cylindrical, Graduated, with Screw type PTFE key, Rotaflow Stopcock and Interchangeable Stopper, Plain Stem.

Cat. No.	Capacity ml.	Price/Piece Rs.
794/1	50	350-00
794/2	100	410-00
794/3	150	550-00
794/4	250	625-00
794/5	500	950-00
794/6	1000	1575-00

795. Dropping Funnels, "LABCO", Cylindrical, open top, with Stopcock, Stem with Cone.

Cat. No.	Capacity ml.	Cone Rs.	Price/Piece
795/1	50	B 19	315-00
795/2	100	B 19	335-00
795/3	100	B 24	350-00
795/4	250	B 19	440-00
795/5	250	B 24	560-00

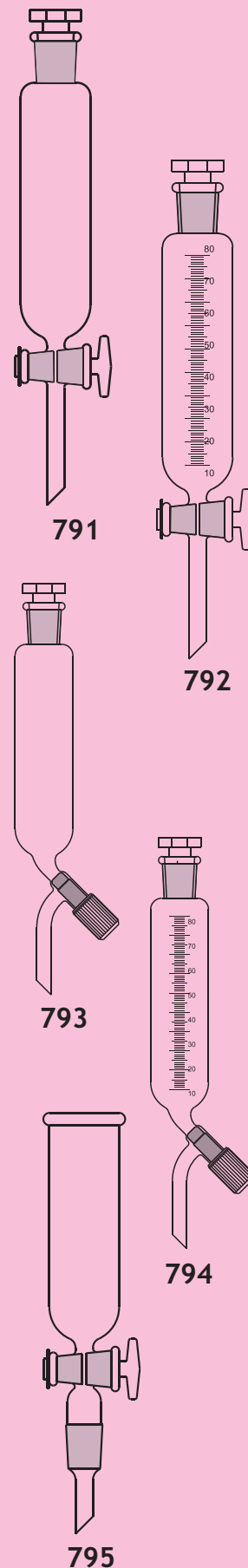

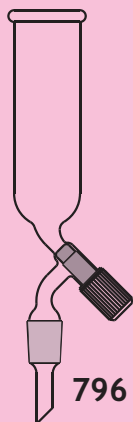

796

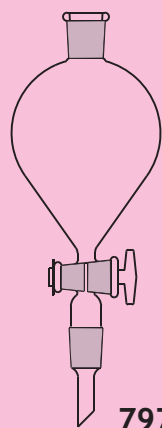

797

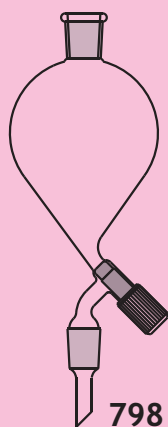

798

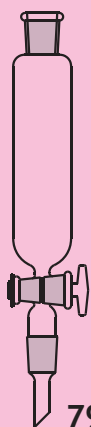

799

- 796. Dropping Funnels, "LABCO",** Cylindrical, open top, with Screw type, PTFE key, Rotaflow Stopcock, Stem with Cone.

Cat. No.	Capacity ml.	Cone Rs.	Price/Piece
796/1	50	B 19	292-00
796/2	100	B 19	340-00
796/3	100	B 24	350-00
796/4	250	B 19	480-00
796/5	250	B 24	560-00

- 797. Separating Funnels, "LABCO",** Pear shape, with socket, stopcock and stem with cone but without stopper.

Cat. No.	Capacity ml.	Socket	Cone	Price/Piece Rs.
797/1	25	B 14	B 14	395-00
797/2	50	B 14	B 14	415-00
797/3	50	B 19	B 19	445-00
797/4	100	B 14	B 14	480-00
797/5	100	B 19	B 19	490-00
797/6	250	B 14	B 14	530-00
797/7	250	B 19	B 19	540-00
797/8	500	B 19	B 19	670-00
797/9	500	B 24	B 24	685-00
797/10	1000	B 19	B 19	1025-00
797/11	1000	B 24	B 24	1045-00

- 798. Separating Funnels, "LABCO",** Pear shape, with socket screw type PTFE key Rotaflow Stopcock and stem with cone but without stopper.

Cat. No.	Capacity ml.	Socket	Cone	Price/Piece Rs.
798/1	25	B 14	B 14	375-00
798/2	50	B 14	B 14	410-00
798/3	50	B 19	B 19	420-00
798/4	100	B 14	B 14	450-00
798/5	100	B 19	B 19	465-00
798/6	250	B 14	B 14	565-00
798/7	250	B 19	B 19	580-00
798/8	500	B 19	B 19	695-00
798/9	500	B 24	B 24	700-00
798/10	1000	B 19	B 19	1070-00
798/11	1000	B 24	B 24	1100-00

- 799. Dropping Funnels, "LABCO",** Cylindrical with socket, stopcock and stem, with cone but without stopper.

Cat. No.	Capacity ml.	Socket	Cone	Price/Piece Rs.
799/1	25	B 14	B 14	365-00
799/2	50	B 14	B 14	385-00
799/3	100	B 14	B 14	425-00
799/4	100	B 19	B 19	435-00
799/5	250	B 19	B 19	525-00
799/6	500	B 19	B 19	760-00
799/7	1000	B 19	B 19	1170-00

800. Dropping Funnels, "LABCO", Cylindrical, with socket, Screw type PTFE key Rotaflow Stopcock and stem with cone but without stopper.

Cat. No.	Capacity ml.	Socket	Cone	Price/Piece Rs.
800/1	25	B 14	B 14	320-00
800/2	50	B 14	B 14	350-00
800/3	100	B 14	B 14	425-00
800/4	100	B 19	B 19	440-00
800/5	250	B 19	B 19	650-00
800/6	500	B 19	B 19	925-00
800/7	1000	B 19	B 19	1375-00

801. Pressure Equilising Funnels, "LABCO", Pear shape, with socket, Glass key stopcock and stem with cone.

Cat. No.	Capacity ml.	Socket	Cone	Price/Piece Rs.
801/1	100	B 19	B 19	760-00
801/2	100	B 24	B 24	790-00
801/3	250	B 19	B 19	815-00
801/4	250	B 24	B 24	845-00
801/5	500	B 19	B 19	1025-00
801/6	500	B 24	B 24	1060-00
801/7	500	B 34	B 34	1175-00

801A. Pressure Equilising Funnels, "LABCO", Pear shape, with socket, PTFE key stopcock and stem with cone.

Cat. No.	Capacity ml.	Socket	Cone	Price/Piece Rs.
801A/1	100	B 19	B 19	1025-00
801A/2	100	B 24	B 24	1050-00
801A/3	250	B 19	B 19	1070-00
801A/4	250	B 24	B 24	1100-00
801A/5	500	B 19	B 19	1325-00
801A/6	500	B 24	B 24	1360-00
801A/7	500	B 34	B 34	1575-00

802. Pressure Equilising Funnels, "LABCO", Cylindrical, with socket, Glass key, stopcock and stem with cone.

Cat. No.	Capacity	Socket	Cone	Price/Piece Rs.
802/1	50	B 19	B 19	615-00
802/2	100	B 19	B 19	650-00
802/3	250	B 19	B 19	750-00
802/4	250	B 24	B 24	770-00
802/5	500	B 24	B 19	1000-00
802/6	500	B 24	B 24	1025-00

802A. Pressure Equilising Funnels, "LABCO", Cylindrical, with socket, PTFE key, stopcock and stem with cone.

Cat. No.	Capacity	Socket	Cone	Price/Piece Rs.
802A/1	50	B 19	B 19	880-00
802A/2	100	B 19	B 19	925-00
802A/3	250	B 19	B 19	1050-00
802A/4	250	B 24	B 24	1060-00
802A/5	500	B 24	B 19	1350-00
802A/6	500	B 24	B 24	1370-00

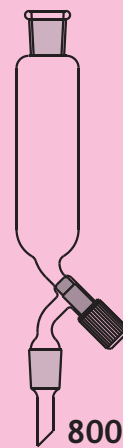

800

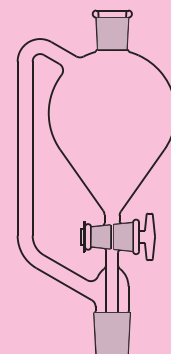

801

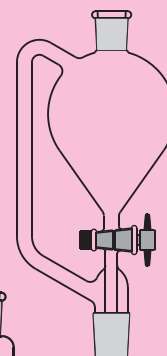

801A

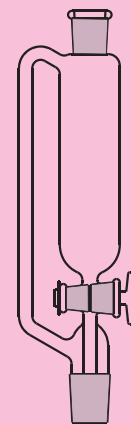

802

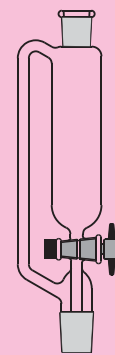

802A

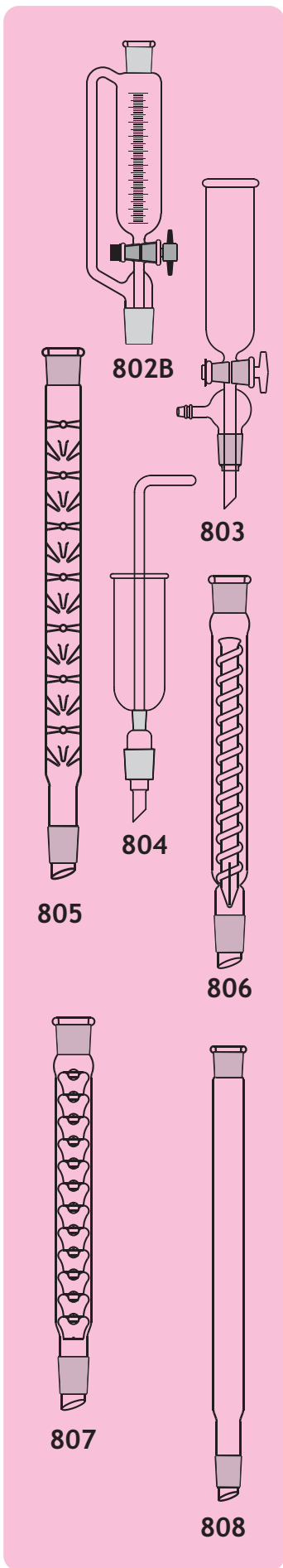

802B. Pressure Equilising Funnels, "LABCO", Cylindrical Graduated with socket, PTFE key, stopcock and stem with cone.

Cat. No.	Capacity	Socket	Cone	Price/Piece Rs.
802B/1	50	B 19	B 19	1125-00
802B/2	100	B 19	B 19	1175-00
802B/3	250	B 19	B 19	1300-00
802B/4	250	B 24	B 24	1310-00
802B/5	500	B 24	B 19	1600-00
802B/6	500	B 24	B 24	1675-00

803. Dropping Funnels, "LABCO", Cylindrical, open top, with Gas outlet tube, Stem with B 24 Cone, Capacity 100 ml. 440-00

804. Plug Type Funnels, "LABCO", Capacity 50 ml., Socket B 10, Cone B 19 335-00

FRACTIONATING COLUMNS

805. Fractionating Columns, "LABCO", Vigrex.

Cat. No.	Socket	Cone	Effective Length mm.	Price/Piece Rs.
805/1	B 24	B 24	360	500-00
805/2	B 24	B 24	600	655-00
805/3	B 29	B 29	360	575-00
805/4	B 34	B 34	600	1040-00

806. Fractionating Columns, "LABCO", Dufton.

Cat. No.	Socket	Cone	Effective Length mm.	Price/Piece Rs.
806/1	B 24	B 19	150	480-00
806/2	B 24	B 19	300	570-00
806/3	B 24	B 24	150	500-00
806/4	B 24	B 24	300	590-00

807. Fractionating Columns, "LABCO", Pear Bulb.

Cat. No.	Socket	Cone	Effective Length mm.	Price/Piece Rs.
807/1	B 34	B 24	130	660-00
807/2	B 34	B 24	250	870-00
807/3	B 34	B 24	500	1450-00

808. Fractionating Columns, "LABCO", Plain designed for use with various types of columns packing

Cat. No.	Socket	Cone	Effective Length mm.	Price/Piece Rs.
808/1	B 24	B 24	250	270-00
808/2	B 24	B 24	500	380-00
808/3	B 24	B 24	750	515-00
808/4	B 34	B 24	250	575-00
808/5	B 34	B 24	500	650-00
808/6	B 34	B 34	600	700-00

809. Packing for Plain Columns, "LABCO".

Cat. No.	Description	Approx. dia mm.	Approx. length mm.	Price/100 gm. Rs.
809/1	Rasching ring N.G.	6	6	130-00
809/2	Rasching ring N.G.	8	8	130-00
809/3	Rasching ring N.G.	10	10	130-00
809/6	Glass Beads N.G Without Holes 4-5mm per 500gms			985-00
809/7	---- do ---- 5-6 mm per 500gms			870-00
809/8	----- do ---- 6-7 mm per 500gms			800-00

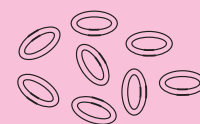

809

810. Packing Support, "LABCO".

Cat. No.	To fit Socket Sizemm.	Diameter Rs.	Price/Piece
810/1	B 19	16	72-00
810/2	B 24	21	82-00
810/3	B 34	29	105-00
810/4	B 40	35	120-00



810

814. Vial Cabinet, "LABCO", for storing vial, made from transparent plexi glass sheet of 5mm thickness, air tight with individual numbering.

Size	Small	Medium	Large
Rate	2150-00	2900-00	3400-00

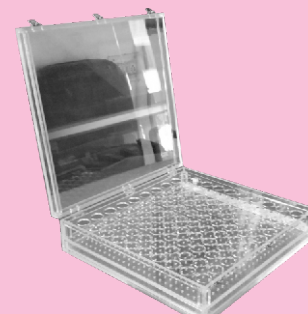

814

814b Vial Cabinet, "LABCO", for storing vial, made from transparent plexi glass sheet of 5mm thickness, air tight with individual numbering with Dessicant drawer type arrangement.

Size	Small	Medium	Large
Rate	3250-00	3950-00	5250-00

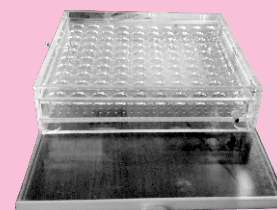

814A

815. Inspection card viewing strip, "LABCO".

450-00

816. Melting Point capillary, "LABCO", either both side open or one end closed size 75mm, 100mm, or 125mm Long. Pk of 100 Pcs., Per Pack

290-00

816a T.L.C. capillary, "LABCO", 100mm Long Pack of 100 Pcs., both side open Per Pack

290-00

817. Memo glass (Tapered), "LABCO", with suitable collar to fit in instrument

695-00

818. Multiple stopper, three in one system, "LABCO".

Size : B19/B24/B29	1150-00
Size : B29/B34/B45	1250-00
Size : B29/B34	1250-00



816



816a

819. Working Tray, "LABCO", Complete SS with specified grooves for keeping certain glasswares.

14250-00

SINTERED GLASSWARE

Porosity Grades and their General Use

Porosity Grade	Pore Size	General Use
G-0	150-250	Coarse Filtration, Gas dispersion and support for other filter material.
G-1	90-150	Coarse Precipitate, Filtration, Gas dispersion, Coarse grain material filtration.
G-2	40-90	Medium and Crystalline precipitate filtration, medium filtration and washing of gases.
G-3	15-40	Fine Gas filtration and dispersion, mercury filtration, Fine grain material filtration, collection of fine precipitates, Analytical Work with medium precipitates.
G-4	5-15	Valves for mercury collection of very fine precipitates. Analytical work with fine precipitates.

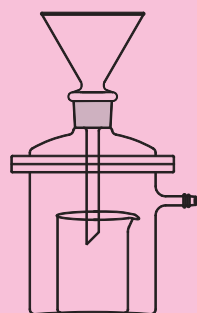

840

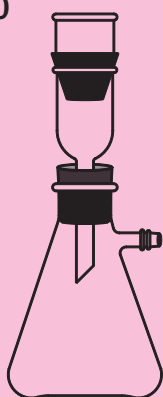

841

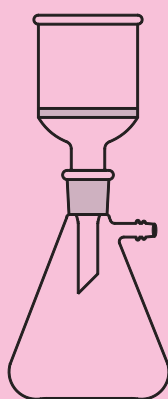

842

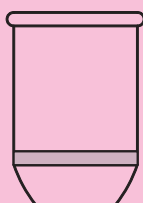

843

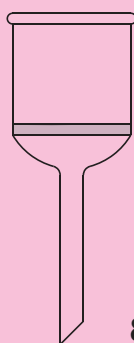

844

840. Filtering Apparatus Witt's, "LABCO", Complete with flanged jar, flanged lid, funnel and 250 ml. beaker. 7700-00
841. Filter Apparatus, "LABCO", Complete with Filtering Flask, gooch crucible with Sintered Disc of Porosity G-0 or G-1 or G-2 or G-3 or G-4, glass adapter and rubber cone.

Cat. No.	Flask Cap. ml.	Crucible Cap. ml.	Price/Piece Rs.
841/1	250	30	700-00
841/2	500	30	800-00
841/3	1000	50	1275-00

Note: Please mention Porosity of Sintered Disc, while placing order.

842. Filter Apparatus, "LABCO", Complete with Filter Flask, with Socket and buchner funnel with Sintered Disc of Porosity G-0 or G-1 or G-2 or G-3 or G-4, having cone.

Cat. No.	Flask Cap. ml.	Buchner funnel Cap. (ml.)	Joint	Price/Piece Rs.
842/1	250	80	B 24	1050-00
842/2	500	200	B 24	1550-00
842/3	1000	500	B 29	3050-00
842/4	2000	1000	B 29	6800-00

Note : Please mention Porosity of Sintered Disc, while placing order.

843. Crucible, "LABCO", Gooch type with Sintered Disc of Porosity G-0 or G-1 or G-2 or G-3 or G-4.

Cat No.	Capacity ml.	Price/Piece Rs.
843/1	15	90-00
843/2	30	100-00
843/3	50	190-00

Note : Please mention Porosity of Sintered Disc, while placing order.

844. Buchner Funnel, "LABCO", with Sintered Disc of Porosity G-0 or G-1 or G-2 or G-3 or G-4, plain stem.

Cat No.	Capacity ml.mm.	Disc Dia mm.	Price/Piece Rs.
844/1	35	30	205-00
844/2	80	40	340-00
844/3	200	65	700-00
844/4	500	90	1650-00
844/5	1000	120	4100-00

Note : Please mention Porosity of Sintered Disc, while placing order.

845. Buchner Funnel, "LABCO", with Sintered Disc of Porosity G-1 or G-2 or G-3 or G-4, cone at stem.

Note : Please mention Porosity of Sintered Disc and cone size, while placing order.

Cat No.	Capacity ml.	Disc Dia mm.	Cone Size	Price/Piece Rs.
845/1	35	30	B 14	365-00
845/1A	35	30	B 19	370-00
845/2	80	40	B 14	510-00
845/2A	80	40	B 19	515-00
845/3	200	65	B 19	935-00
845/3A	200	65	B 24	945-00
845/4	500	90	B 24	1950-00
845/4A	500	90	B 29	2000-00
845/5	1000	120	B 24	4800-00
845/5A	1000	120	B 29	4850-00

846. Millipore Type, Membrane Filter Holder Assembly, "LABCO", with membrane support, Funnel, Flask and Clamp, Standard Joint Fitting.

Cat. No.	Membrane dia. mm.	Funnel Cap. ml.	Flask Cap. ml.	Price/Piece Rs.
846/1	25	25	250	2450-00
846/2	25	50	500	2650-00
846/3	47	300	1000	4400-00
846/4	47	300	2000	5100-00
846/5	90	1000	5000	34750-00

846a Spares Flask for Membrane Filter Holder assembly, "LABCO".

Cat No.	Capacity ml.	Price/Piece Rs.
846a/1	250	540-00
846a/2	500	760-00
846a/3	1000	1280-00
846a/4	2000	2025-00
846a/5	5000	5900-00

846b Filtration Assembly "LABCO", (Single Unit, All glass) Complete with Vaccum pump & below accessories 29250-00

- Filter holder Assembly with membrane support, Funnel, Flask 1Ltr. & Clamp. All standard joint fittings
- Membrane filter 47mm/0.4µm(pack of 100) -- 1Pack
- Suitable Vaccum pump Oil free -- 1Pc
- Air vent filter Hydrophobic PTFE 50mm/0.2µm -- 1Pc
- Syringe type PTFE Membrane filter 25mm/0.45µm with needle -- 1Pc
- Vaccum tubing 1mtr. -- 1Pc
- Forcep ---- 2Pcs

846c Filtration Assembly "LABCO", (Single Unit, Filter Holder Assembly Made of SS-316) Complete with Vaccum pump & below accessories 35250-00

- Filter holder Assembly with SS-316 funnel filter holder assembly, Vaccum Flask (Glass) 1Ltr.
- Membrane filter 47mm/0.4µm(pack of 100) -- 1Pack
- Suitable Vaccum pump Oil free -- 1Pc
- Air vent filter Hydrophobic PTFE 50mm/0.2µm -- 1Pc
- Syringe type PTFE Membrane filter 25mm/0.45µm with needle -- 1Pc
- Vaccum tubing 1mtr. -- 1Pc
- Forcep ---- 2Pcs

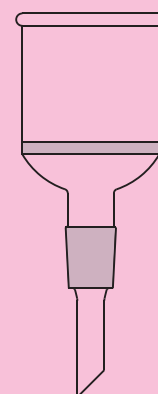

845

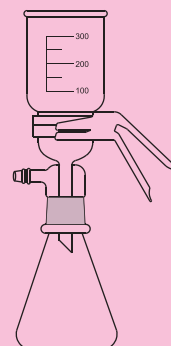

846

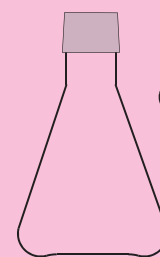

846a

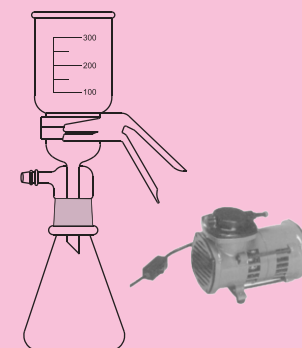

846b

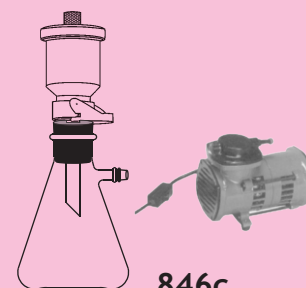

846c

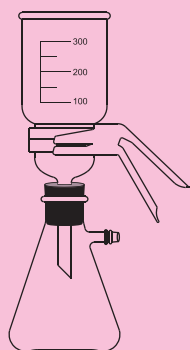

847

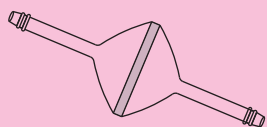

848

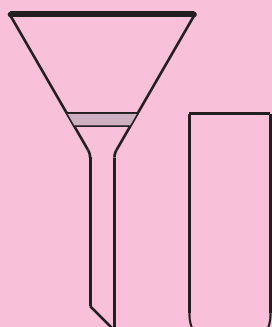

849



850

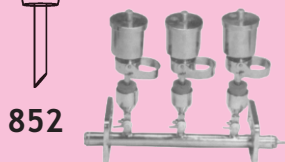

852

853



855



855a

847. Millipore Type, Membrane Filter Holder Assembly, "LABCO", with membrane support, Funnel, Flask and Clamp, Neoperene Rubber Cork fitting.

Cat. No.	Membrane dia. mm.	Funnel Cap. ml.	Flask Cap. ml.	Price/Piece Rs.
847/1	25	25	250	2200-00
847/2	25	50	500	2475-00
847/3	47	300	1000	4150-00
847/4	47	300	2000	4500-00
847/5	47	300	5000	7200-00

848. Tube Sealed, "LABCO", with reduced ends, with Sintered Disc (Pipe line filter) Porosity G-0 or G-1 or G-2 or G-3 or G-4.

Cat. No.	Disc. dia mm	Price/Piece Rs.
848/1	30	415-00
848/2	40	625-00
848/3	50	845-00
848/4	65	1600-00
848/5	90	2550-00

Note : Please mention Porosity of Sintered Disc, while placing order.

849. Conical Filter, "LABCO", (Hirsch type) with Sintered Disc of Porosity G-0 or G-1 or G-2 or G-3 or G-4.

Cat No.	Capacity ml. mm.	Disc Dia Rs.	Price/Piece Rs.
849/1	20	20	300-00
849/2	60	30	370-00
849/3	100	30	440-00

Note : Please mention Porosity of Sintered Disc, while placing order.

850. Sintered Glass Filter Tube, "LABCO", with Sintered Disc sealed in Centre, Porosity G-0 or G-1 or G-2 or G-3 or G-4.

Cat. No.	Disc dia. mm	Price/Piece Rs.
850/1	10	200-00
850/2	20	250-00
850/3	30	350-00
850/4	40	600-00
850/5	50	940-00
850/6	90	3300-00

Note : Please mention Porosity of Sintered Disc, while placing order.

852. Filter SS 316 Filter Holder Assembly, "LABCO", Millipore type 47mm dia 6300-00

853. Filter Holder, "LABCO", with 3 branch Sterility test 47mm S.S. 47000-00

854. Filter Holder, "LABCO", with 6 branch Sterility test 47mm S.S. 93500-00

855. Oil free Portable Vacuum pumps, "LABCO", (Diaphragm type)

Cat. No.	Max Flow (Lts Min/in Hg)	Max. Vaccum	Max. psig	Motor HP	Price/piece Rs.
855/1	15	22"	25	1/20	10200-00
855/2	25	27"	35	1/16	17800-00
855/3	45	22"	40	1/8	19900-00
855/4	75	22"	45	1/4	25300-00

Chemical Resistant pump, VALUE, Made of Teflon (Diaphragm Type)

855/5 28 27" 55 1/4 34000-00

855a. Hand Vacuum pump, plastic with gauge, "LABCO". 5800-00

DISTILLATION ASSEMBLIES

- 865** Distillation Assembly, "LABCO", Comprising of R. B. Flask 2000ml, Splash head, Double Surface condenser and Receiver adapter 2450-00
 Same as above, Cap.of flask 5 litre 5150-00
 Same as above, Cap. of flask 10 litre 9300-00
- 865/1** Distillation Assembly, "LABCO", Consisting of R. B. Flask 500 ml, Still Head, Leibig's Condensers 300 mm Receiver adapter Bend, Tap funnel 50 ml and Stopper B-14 1750-00
- 865/2** Distillation Assembly, "LABCO", Consisting of Flask R. B. 1000 ml, Recovery Bend, Thorpe condenser 200 mm and Receiver Adapter Straight. 2050-00
- 865/3** Distillation Assembly, "LABCO", Consisting of R. B. Flask, Recovery Bend, Condenser leibig and Receiver adapter Bend.

Cat. No.	Flask Cap. ml	Price/Piece Rs.
865a/1	250	1000-00
865a/2	500	1200-00
865a/3	1000	1375-00
865a/4	2000	2150-00
865a/5	3000	6200-00
865a/6	5000	7800-00
865a/7	10000	16000-00

- 865/4** Distillation Assembly, Comprising of R. B. Flask, 3000 ml, Splash Head Adapter, Still Head, Thermometer, Air Condenser 400 mm, Ether condenser, Reduction Adapter and Conical Flask 1000 ml. 6750-00
- 866** Steam Distillation Assembly, "LABCO", Comprising of R. B. Flask two neck 500 ml, Air Leak Tube, Splash head, Condenser Leibig 200 mm and Receiver adapter bend. 1850-00
- 866/1** Steam Distillation Assembly, "LABCO", Consisting of R. B. Flask 500 ml, Steam Distillation Head, Leibig condenser and Receiver adapter Bend. 1400-00
- 866/2** Steam Distillation Assembly, "LABCO", Consisting of R.B. Flask 1000 ml, Multiple adapter two neck, Air leak tube, Recovery bend, Coil condenser jacketed 200 mm and Receiver adapter straight. 2000-00
- 866/3** Steam Distillation Apparatus, "LABCO", for fluoride Determination as per I.S Specification. 3650-00
- 867** Preparation Assembly, "LABCO", Consisting of R. B. Flask, Still head, Thermometer, Leibig condenser & receiver adapter.

Cat. No.	Flask Capacity ml	Condenser Effective Length mm	Price Rs.
867/1	500	350	1750-00
867/2	1000	350	2000-00
867/3	2000	400	2900-00

- 868** Vacuum Distillation Assembly, "LABCO", Consisting of R. B. Flask 3000 ml, Multiple adapter, Tap funnel 250 ml, Stopper, Still head, Thermometer, Condenser Jacketed Coil 200 mm, Receiver adapter with two socket and cone, Vacuum release stopcock and R. B. Flask 250 ml. 10800-00
- 868/1** Vacuum Distillation Assembly, "LABCO", Consisting of R. B. Flask 100 ml, Multiple adapter, Tap funnel 250 ml, Stopper, Still head, Thermometer, Air condenser 400 mm, Receiver adapter and R. B. Flask 50 ml. 4800-00

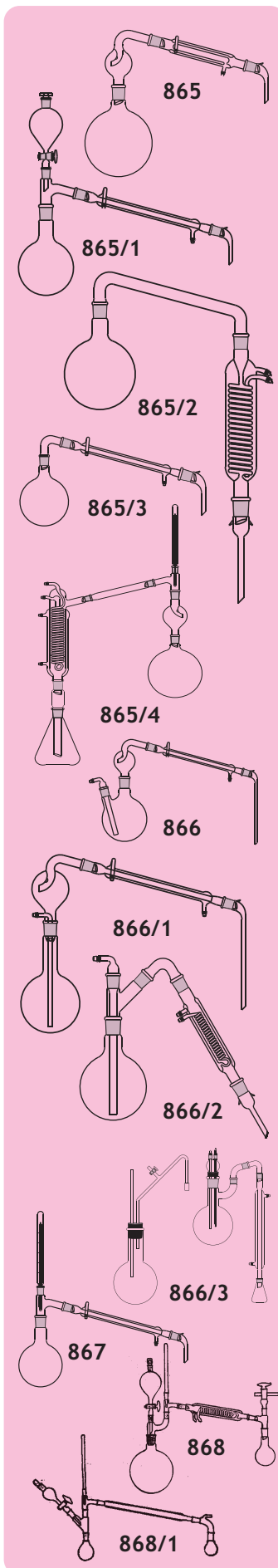

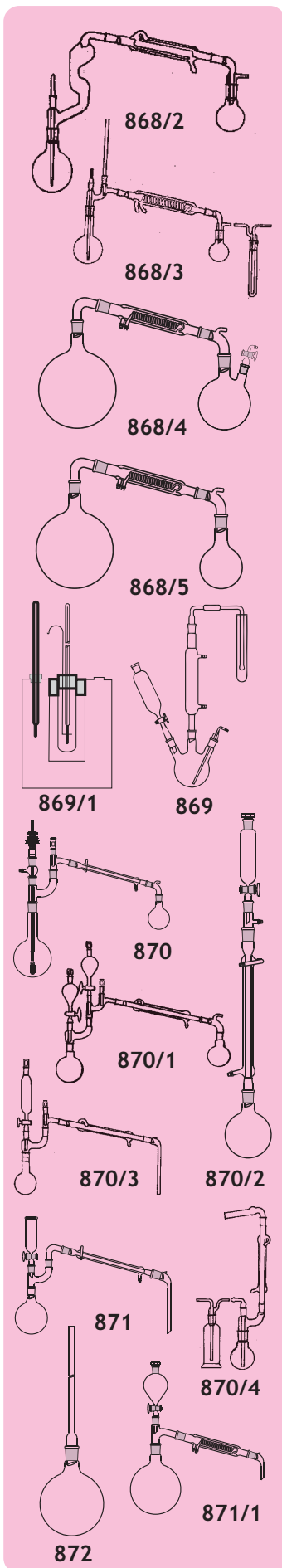

- 868/2 Vacuum Distillation Assembly, "LABCO",** Consisting of R. B. Flasks 500 ml, Splash head Double bulb, Air leak tube, Double surface condenser 200 mm, Reciever adapter Vacuum and R. B. Flask 100 ml. 5700-00
- 868/3 Vacuum Distillation Assembly, "LABCO",** Consisting of R. B. Flask 500 ml, Clasion head, Air leak tube, Thermometer, Jacketed coil condenser 200 mm, Reciever adapter Vacuum, R. B. Flask 100 ml, Test Tube 200 ml with socket and Gas wash bottle fitting. 6200-00
- 868/4 Vacuum Distillation Assembly, "LABCO",** Consisting of R.B. Flask 1000 ml, Recovery bend, Double coil condenser 200 mm, R. B. Flask two neck 500 ml and Vacuum release stopcock. 5450-00
- 868/5 Vacuum Distillation Assembly, "LABCO",** Consisting of R. B. Flask 1000 ml, Recovery bend, Jacketed coil condenser 200 mm, Reciever adapter with vent and R. B. Flask 250 ml 2050-00
- 869 Sulfur Dioxide Assembly, as per USP, "LABCO".** 4200-00
- 869/1 Congealing Temperature Apparatus, without Thermometer "LABCO".** 5100-00
- 869/2 Congealing Temperature Apparatus, "LABCO",** with NABL Certified Thermometer. Range -20°C to 150°C, Sub Div. 0.2°C 10250-00
- 870 Reaction Assembly, "LABCO",** Consisting of R. B. Flask 500 ml, Multiple adapter two neck, Stirrer guide, Stuffing box gland link stirrer, Still head, Thermometer Pocket, Condenser Liebig's, Reciever adapter bend with vent and R. B. Flask 100 ml. 5250-00
- 870/1 Reaction Assembly, "LABCO",** Consisting of R. B. Flask 500 ml, Multiple adapter two neck, Tap funnel 100 ml, Stopper, Thermometer Pocket, Condenser Liebig's, Receiver adapter Bend with vent and R. B. Flask 250 ml. 5000-00
- 870/2 Reaction Assembly, "LABCO",** Consisting of R. B. Flask 500 ml, Leibig's Condenser, Adapter 'T' connection, Tap Funnel 100 ml and Stopper. 2750-00
- 870/3 Reaction Assembly, "LABCO",** Consisting of R. B. Flask 250 ml , Multiple adapter two neck, Tap funnel 100 ml, Stopper, Still head, Condenser Leibig, Receiver adapter bend and Thermometer pocket. 3250-00
- 870/4 Reaction Assembly, "LABCO",** Consisting of R. B. Flask 250 ml, Multiple adapter two neck, Air leak Tube, Condenser Leibig, Drying tube and Gas wash bottle 250 ml. 3000-00
- 871 Recovery Assembly, "LABCO",** Consisting of R. B. Flask 250 ml, Multiple adapter two neck, Tap funnel 50 ml, Recovery bend, Condenser leibig and Reciever adapter. 1700-00
- 871/1 Recovery Assembly, "LABCO",** Consisting of R. B. Flask 2000 ml, Still head, Tap funnel 100 ml, Stopper, Coil condenser jackted and Receiver adapter bend. 3000-00
- 872 Reflux Assembly, "LABCO".**

Cap of flask	Joint	Length of Air condenser	Joints	Price/Piece Rs.
100 ml	B 24	500 mm	B 24	495-00
250 ml	B 24	750 mm	B 24	515-00
500 ml	B 24	1000 mm	B 24	625-00

872/1 Reflux Assembly, "LABCO",

Cap of flask	Joint	Length of Leibig condenser	Joint	Price/Piece Rs.
250 ml	B 24	300 mm	B 24	625-00
500 ml	B 24	400 mm	B 24	725-00
1000 ml	B 24	400 mm	B 24	860-00

872/2 Reflux Assembly, "LABCO", Consisting of R. B. Flask 500 ml, Multiple adapter with two neck, Stirrer guide, Rubber sleeve gland, Link stirrer and Allihan condenser. 1825-00

872/3 Reflux Assembly, "LABCO", Consisting of R.B. Flask 1000 ml, Multiple adapter three neck, Stirrer guide, Rubber Sleeve gland, Collapsible Paddle Stirrer, Tap funnel 100 ml, Stopper, Coil condenser 150 mm and Drying Tube. 2875-00

873 Fractionation Assembly, "LABCO", Consisting of R. B. Flask 500 ml, Cup joint adapter with S. 35 socket, Joint clip S. 35, Air condenser 400 mm, Multiple adapter, Immersion condenser, Still head, Thermometer pocket, Leibig condenser 400 mm, Receiver Adapter and Ball joint Adapter with S. 35 Ball. 3250-00

873/1 Fractionation Assembly, "LABCO", Consisting of R. B. Flask 250 ml, Air Condenser 300 mm, Still head, Thermometer, Leibig condenser 200mm, Bend with Multiple connection and R. B. Flask 3 x 25 ml. 3275-00

874 Vacuum Drying pistol, "LABCO", Consisting of R. B. Flask 100 ml, Still head, Tap adapter, jacketed tube 200 mm, Coil condenser 150 mm and R. B. Flask 250 ml. 3250-00

875 Kunderna danish Evaporators, "LABCO", Consisting of R. B. Flask 150 ml, Upper chamber 250 ml, and Kunderna column 7400-00

876 Cyanide Distillation Apparatus, "LABCO". 3450-00

876a Assembly of Apparatus for the Determination of Mancozep Content, "LABCO". 5500-00

876b Carbaryl Content Determination Apparatus, "LABCO", as per I.S. Specification. 3250-00

877 Mercury Distillation Assembly, "LABCO", Hulett, Consists of distillation flask 500 ml, Stopcock controlled air bleeding tube, Air condenser 500 mm, Liebig condenser 200 mm, Vacuum receiver adapter and Receiving bottle. 2500-00

878 Methoxy Determination Assembly as per USP, "LABCO", 7850-00

878/1 Hydroxypropoxy Determination Apparatus, "LABCO", 7400-00

879 Vacuum Sublimation Assembly, "LABCO", Consisting of Test Tube 28 x 200 mm, Adapter with 'T' connection and Immersion condenser. 985-00

880 Solvent Recovery Assembly, "LABCO", Consisting of R. B. Flask 150 ml, Recovery bend, Coil Condenser jacketed 200 mm and Receiver adapter. 1550-00

880a Assembly of Apparatus, "LABCO", for Titer Test as per I.S 548 (Part I) 1964 with calibrated thermometers 19900-00

880b Steam Distillation, "LABCO", Apparatus for Fluoride Determination. As per I.S. Specs. 3650-00

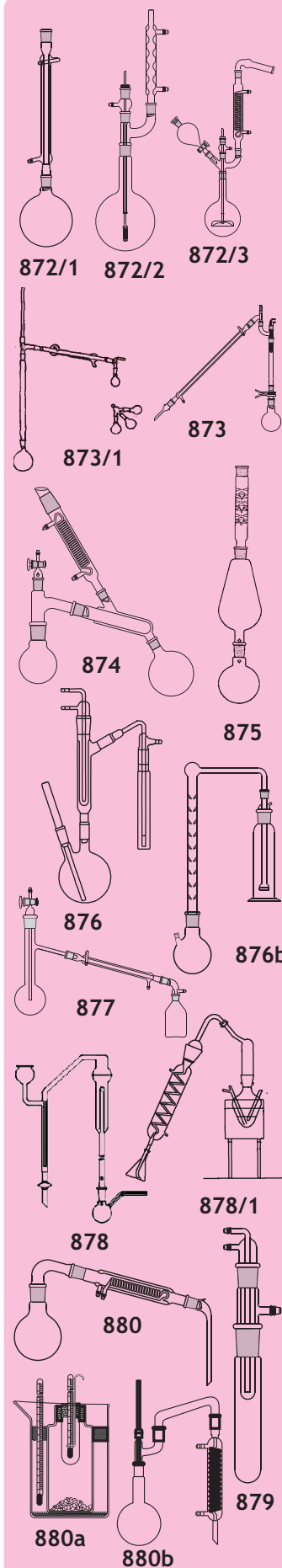

FORMALDEHYDE CONTENT DETERMINATION APP.

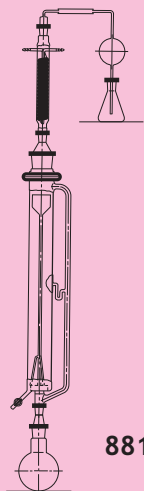

881

- 881** Determination of Formaldehyde Content by Perforator Method, "LABCO", As per British Standard BS EN 120:1992 Consist of spiral condenser 400mm, Reduction adapters, filter insert (Porosity 100m to 160m), Perforator attachment 1000ml, R.B. flask 1Ltr., Double bulb tube with absorption bulb. Complete with heating mantle cap. 1000ml, Stand and clamps to hold the apparatus vertically straight. 52500-00
- 881a** --- do --- Same as above but without heating mantle, Stand & Clamps (Only Glass Parts) 48500-00

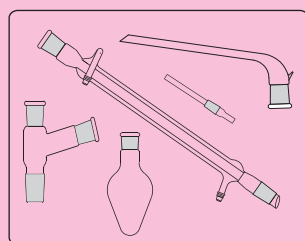

881b

- 881b** Complete Set comprising 5 items of Glassware, "LABCO", 29 BU/M Pear shaped Flask 50ml, Still head, Liebig Condenser, Receiver Adapter Bend, Receiver Adapter Long. 1 each 2100-00

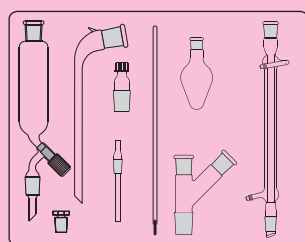

881c

- 881c** Complete Set Comprising of 9 items of Glassware, "LABCO", 27BU/M Pear Shaped Flask 50ml, Still Head, Liebig Condenser, Screw Cap Adapter, Receiver Adapter, Air Leak/Stem Inlet Tube, Dropping Funnel 50ml R/F Stopcock, Stopper & Thermometer. 1each 3100-00

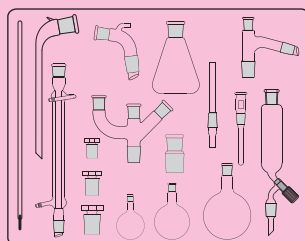

881d

- 881d** Complete Set Comprising of 16 items of Glassware, "LABCO", 34BU/M, Still Head, Receiver, Air Leak/Steam Inlet Tube, Liebig Condenser, Dropping Funnel 100ml, Reduction Adapter, Multiple Adapter, R/B Flask 50ml, 100ml & 250ml, Conical Flask 250ml, Stoppers 3 nos, Thermometer Pocket, Receiver Adapter & Thermometer. 6200-00

QUARTZ DISTILLATION APPATATUS

- 881e** Water Distillation Apparats, "LABCO", QUARTZ BOILER with inbuilt heater and glass condenser of Boro 3.3 Exp. Glass, Complete with stand Clamps etc. The Distilled water produced is suitable for HPLC. With safety cut off device unit.
- Output Approx - 2.0 Ltr/hr 46500-00
Output Approx - 5.0 Ltr/hr 64500-00

Spares for above :

- 881e/1 Quartz boiler for 2.0 Ltr./hr. 29500-00
881e/2 Quartz boiler for 5.0 Ltr/hr. 42500-00
881e/3 Condenser for 2.0 Ltr./hr. 4650-00
881e/4 Condenser for 5.0 Ltr./hr. 9250-00
- 881f** Double Distillation Apparatus, "LABCO", prepared in single column like tube, built in both heaters with demountable heater, Complete with stand clamps etc. The Distilled water produced is suitable for HPLC. Complete with safety cut off device unit
- Output Approx 1.5 Ltr./hr 124500-00
Output Approx 2.5 Ltr./hr 172000-00
Output Approx 3.5 Ltr./hr 272000-00



881f

ELECTRICAL EMBEDDED HEATER DISTILLATION APPARATUS (N.P.L. DESIGN)

882 Automatic Electrically Heated, "LABCO", All Glass Distillation apparatus, complete with Metallic stand, Plug and Board etc. (Heater of "KANTHAL" Sweden)

Cat. No.	Description	Cap. of Flask	Price/Piece
882/1	Single distillation without cut off	3 Litre	15900-00
882/2	Single distillation with Auto cutoff/ Auto on	3 Litre	20500-00
882/3	Single distillation without cut off	5 Litre	16500-00
882/4	Single distillation with Auto cut off/ Auto on	5 Litre	21750-00
882/5	Single distillation without cut off	10 Litre	19700-00
882/6	Single distillation with Auto cut off/ Auto on	10 Litre	25500-00
882/7	Double distillation without cut off	3 Litre	28400-00
882/8	Double distillation with Auto cut off/ Auto on	3 Litre	33500-00
882/9	Double distillation without cut off	5 Litre	31100-00
882/10	Double distillation with Auto cut off/ Auto on	5 Litre	36800-00
882/11	Double distillation without cut off	10 Litre	39400-00
882/12	Double distillation with Auto cut off/ Auto on	10 Litre	43200-00
882/13	Triple distillation without cut off	3 Litre	41900-00
882/14	Triple distillation with Auto cut off/ Auto on	3 Litre	47500-00
882/15	Triple distillation without cut off	5 Litre	45700-00
882/16	Triple distillation with Auto cut off/ Auto on	5 Litre	50700-00
882/17	Triple distillation without cut off	10 Litre	55490-00
882/18	Triple distillation with Auto cut off/ Auto on	10 Litre	60400-00
882/19	Spare flask capacity	3 Litre.	7700-00
882/20	Spare flask capacity	5 Litre.	8500-00
882/21	Spare flask capacity	10 Litre.	12900-00
882/22	Spare condenser for	3 & 5 Litre flask	2700-00
882/23	Spare condenser for	10 Litre flask	3000-00
882/24	Stand for single distillation Appratus for	3, 5 & 10 Ltr. flask	6200-00
882/25	Stand for double distillation Appratus for	3, 5 & 10 Ltr. flask	13800-00
882/26	Auto Cutoff and Auto on device for single unit		6200-00
882/27	do - for double unit		6600-00
882/28	-do - (for Triple unit)		7700-00
882/29	Receiving tube for condensor, "LABCO".		500-00

Two Bed Demineraliser

882a A set of PVC /FRP columns, charged with high exchange capacity cation & anion resin with prefilter. It softens the hard water and provides good quality water for use in labs. Specially designed for easy serviceability and recharging the resin with solution. The soften water can be used as feed water to the distillation unit. The use of hard water in Boilers, would leave the boiler with lot of scaling and sedimentation, hence to improve the quality of distillate and for longer life of the glass/heaters, **it is recommended to use softened water. for Cat. No. 881a, 882 and 883** 31500-00

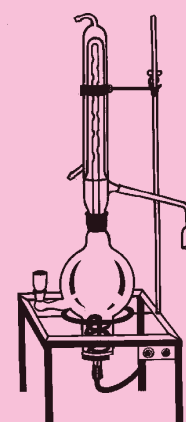

882

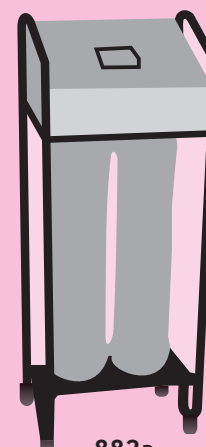

882a

WATER STILL WITH SILICA SHEATHED HEATERS

883 Water Still with Silica Sheathed Heaters, "LABCO", water stills are carefully designed to produce high purity pyrogen free distilled water. The water still of boro 3.3 Exp. glass comprises of horizontal type boiler, condenserr, constant level device, silica sheathed (Quartz) heater, along with stand and clamps. All parts are replaceable.

Features

- Boro 3.3 Exp. condenser & boiler are fitted with a removable silica sheathed heater & connectors for ease of cleaning when scaling is formed.
- Distillate temp. is around 25 to 45 °C which is ensured by an efficient condenser.
- The stand is powder coated for rust free operation and lustrous appearance.
- The unit automatically switches off if water level in the boiler falls below heater.
- Cooling water from the condenser is re-circulated into the boiling chamber, having saving energy.
- Boiler is provided with a replaceable side over flow for easy draining and cleaning or boiling chamber, which also reduces the chances of breakage.
- Fuse is provided for safety in case of voltage fluctuation or short circuit.
- Electric power : 220/240V, 50Hz, Single phase supply

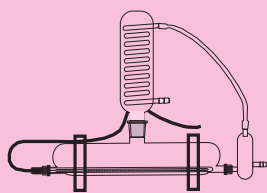

883

Single Still

Conductivity		1 to 2.0µS/cm		
pH		5.5-6.0µS/cm		
Cat No.	Output	Cooling water Consumption (ltr/hr)	Power Rating KW	Price/Piece Rs.
883/1	1.5-2Ltr./hr.	40Ltr./hr.	1.5KW	26000-00
883/2	3-4Ltr./hr.	120Ltr./hr.	3.0KW	35400-00

Double Still

Conductivity		0.8 to 1µS/cm		
pH		6.0-7.0		
Cat No.	Output	Cooling water Consumption (ltr/hr)	Power Rating KW	Price/Piece Rs.
883/3	1.5-2Ltr./hr.	80Ltr./hr.	3.0KW	35250-00
883/4	3-4Ltr./hr.	150Ltr./hr.	6.0KW	68000-00

Replacement parts of Water Still

883/5	Boiling Chamber 1.5 -2 litre/hr.	6750-00ea
883/6	Boiling Chamber 3-4 litre/hr.	10600-00ea
883/7	Constant level device	950-00ea
883/8	Condensor for water still for 1.5 litre/hr.	4750-00ea
883/9	Condensor for water still for 3.0 litre/hr.	6400-00ea
883/10	Reciever adapter	350-00Ea
883/11	Silica Sheathed heater	4500-00Ea

CHILLER

883/12 Chiller Refrigerated Circulator has built in circulating pump and water tank of rust proof stainless steel. The built in pump has a flow rate of 2.5 meters and internal tank capacity 25 Litres. The temperature is controlled by a **digital temp. indicator cum controller**.

Construction : The body of chiller is mounted on a sturdy angle frame with inner chamber consisting of thick polished stainless steel reservoir with cooling coil duly soldered on the outside of the same to ensure perfect cooling from -5°C to below ambient : The hollow space between the inner chamber and outer wall is filled with high grade insulation to prevent loss of temperature. the refrigeration system consisting of hermetically sealed ISI marked reputed make compressor for minimum noise level and smooth operation.

120000-00

Note : Installation charges for Cat. No. 881a, 881b, 882 & 883 will be 4400-00

884 Distillation Apparatus Vertical, "LABCO", Vertical type : Gives pyrogen free distilled water (Most suitable for injectable purpose) with special double walled condenser, all interchangeable fittings with automatic ejecting arrangement and water level device.

Single stage :

Cap.	1000 ml	2000 ml	3000 ml	5000 ml
Price :	3150-00	4500-00	6950-00	8500-00

Double stage :

Cap.	1000 ml	2000 ml	3000 ml	5000 ml
Price :	6500-00	9000-00	12900-00	17000-00

885 Distillation Apparatus, "LABCO", With Graham condenser with standard joint and stopper. Capacity of flask - 500 ml. and Condensor length is 200 mm

886 Distillation Apparatus, "LABCO", With Friedrich's condenser fitted with standard ground glass joints Capacity of flask 1000 ml

887 Distillation Apparatus for determination of Ammonia in water, "LABCO", Consisting of Kjeldhal flask 500 ml with B 24 socket coil condenser of 200 mm with B 24 socket.

887a. Distillation Apparatus, "LABCO", consists of 2000 ml flask, friedrich's condenser & stopper

888 Kozelka & Hine Blood Test Apparatus, "LABCO", Complete with two digestion flask with cap and with all interchangeable fittings

889 Cavett Flask, "LABCO", A 50 ml conical flask with special B 24 stopper carrying a small constitutes, an apparatus for the rapid microscale determination of Alcohol in blood.

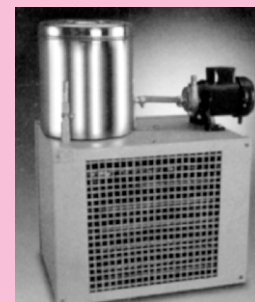

883/12

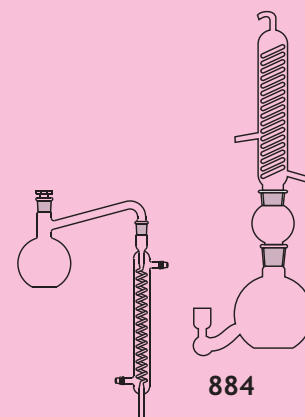

884

885

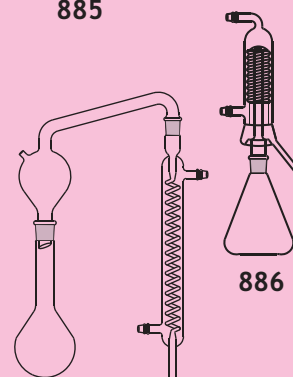

886

887

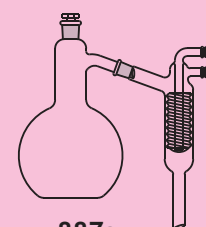

887a

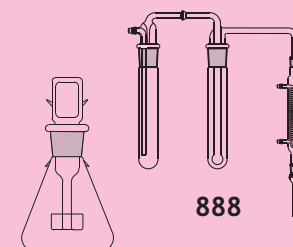

888

889

MOISTURE DETERMINATION APPARATUS

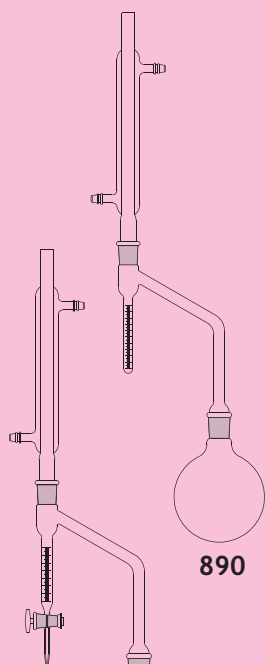

890

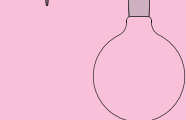

891

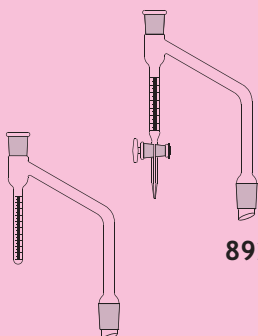

892

893

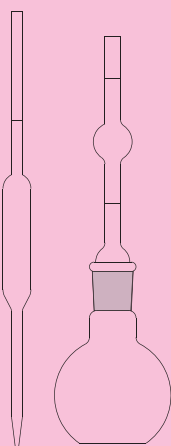

894

890 Moisture determination Apparatus (Dean & Stark) Light Entrainer without stopcock, "LABCO".

Receiver Capacity 2 ml. Flask Cap. 250 ml.	1275-00
Receiver Capacity 5 ml. Flask Cap. 500 ml.	1425-00
Receiver Capacity 10 ml. Flask Cap. 1000 ml.	1625-00
Receiver Capacity 25 ml. Flask Cap. 1000 ml.	1725-00

890L Moisture Determination Unit, "LABCO", Dean & Stark with **NABL** Certificate

Cat. No.	Cap. of Receiver without Stopcock (ml)	Cap. of R.B. Flask ml.	Price/Piece Rs.
890L/1	2	250	1650-00
890L/2	5	500	1850-00
890L/3	10	1000	2050-00
890L/4	25	1000	2100-00

891 Moisture determination apparatus (Dean & Stark) Light Entrainer with stopcock, "LABCO".

Receiver Capacity 2 ml. Flask Cap. 250 ml.	1475-00
Receiver Capacity 5 ml. Flask Cap. 500 ml.	1675-00
Receiver Capacity 10 ml. Flask Cap. 1000 ml.	1875-00
Receiver Capacity 25 ml. Flask Cap. 1000 ml.	1975-00

891L Moisture determination unit, "LABCO", Dean & Stark with **NABL** Certificate

Cat. No.	Cap. of Receiver Without Stopcock (ml)	Cap. of R.B. Flask ml.	Price/Piece Rs.
891L/1	2	250	1875-00
891L/2	5	500	2075-00
891L/3	10	1000	2200-00
891L/4	25	1000	2350-00

892 Spare receiver for Dean and Stark with stopcock cap. 2, 5, 10 or 25 ml for (Cat. No. 891)

925-00

892L Spare receiver for Dean and Stark with stopcock Cap. 2, 5, 10 or 25ml CL-A with **NABL** Certificate for (Cat. No. 891)

1275-00

893 Spare receiver for Dean and Stark without stopcock cap. 2, 5, 10 or 25 ml for (Cat. no. 890)

750-00

893L Spare receiver for Dean and Stark with stopcock Cap. 2, 5, 10 or 25ml CL-A with **NABL** Certificate for (Cat. No. 890)

1100-00

894 Soil moisture gauge, "LABCO", For rapid determination of soil moisture content. The device takes less than 5 minutes, simple, inexpensive, suitable for field use. Highly useful in irrigation and compaction control programmes.

1200-00

ESSENTIAL OIL DETERMINATION APP.

- 895 Essential Oil Determination App., "LABCO",** Cocking & Middleton for the determination of Volatile oil in drugs, Comprising of flask and vertical tube, combined with condenser and measuring tube with stopcock. A return tube for the aqueous part of distillate connects the bottom of the measuring tube and the Vertical tube.

Cat. No. Cap. ml	FlaskMin. Qty./Pack	Price/Piece Rs.	
895/1	1000	2	2475-00
895/2	2000	2	2900-00
895/3	3000	1	5400-00
895/4	5000	1	6600-00
895/5	10000	1	11500-00
895/6	20000	1	18500-00

- 896 Clevevger Apparatus** For the determination of volatile oil lighter than water, comprising of 1000 ml flask, oil separatory tube and condenser. IS Standard 1850-00
- 896a Spare Oil Separatory Tube** 970-00
- 897 Clevevger Apparatus** For the determination of volatile oil heavier than water, comprising of 1000 ml flask, oil separatory tube and condenser. IS Standard 1850-00
- 897a Spare Oil Separatory Tube** 970-00

NITROGEN DETERMINATION APP.

- 898 Kjeldhal Distillation Assembly, "LABCO",** Consisting of Kjeldhal flask 500 ml, Multiple adapter, Tap funnel 50 ml, Splash head, Condenser Leibig 300 mm and Receiver adapter. 2350-00
- 899 Micro Kjeldhal Distillation, "LABCO",** Comprising of similar parts as per Cat. No. 898, but with spherical joints in between splash head and condenser but without receiver adapter. 2800-00
- 900 Kjeldhal Distillation Assembly, "LABCO",** Consisting of R.B. flask 1000 ml, multiple adapter, Tap funnel 50 ml. splash head, condenser leibig 300 mm and receiver adapter. 2600-00
- 901 Micro Nitrogen Determination, "LABCO",** (Leurquin Apparatus) Ammonia is entertained in a steam of air which may be drawn through the tubes using an ordinary filter pump, digestion and Distillation can be carried out in the same test tube and a number of determination can be carried out simultaneously. Alkalisiation unit comprising of absorption head with plug aeration head and 2 test tubes 1475-00

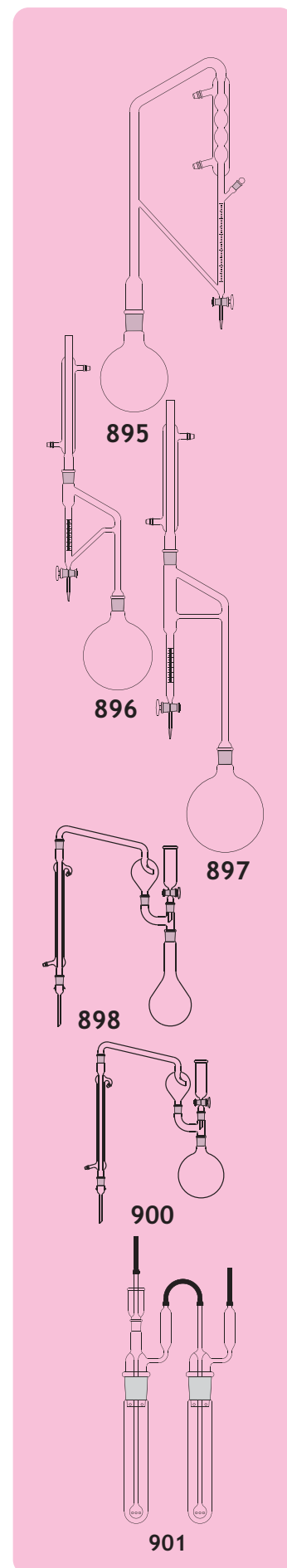

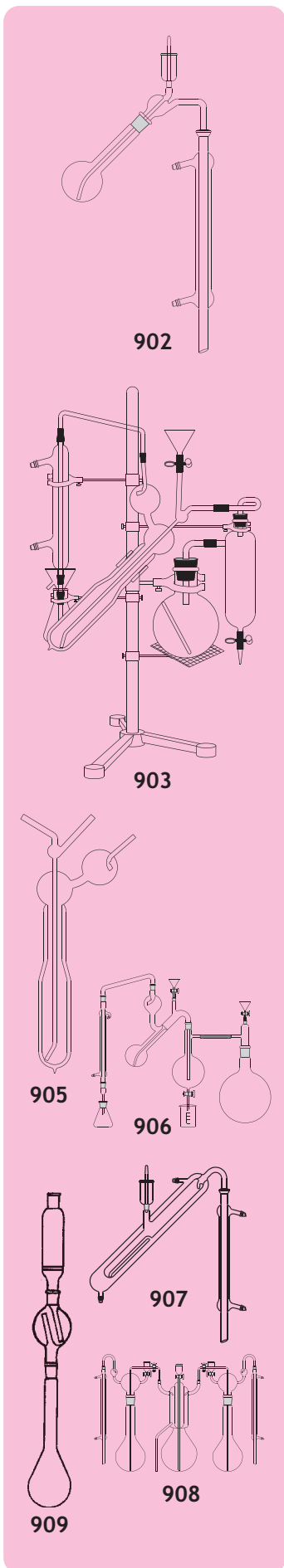

902 Semi Micro Kjeldahl Apparatus, "LABCO", as per Quickfit Cat 21/50 M.C., or 21/100 M.C.

Cat. No.	Description	Price/Piece Rs.
902/1	Comprising of 50 ml. flask, distillation head with funnel, plug and condenser.	1750-00
902/2	Comprising of parts of 902/1 apparatus but with flask capacity of 100 ml.	1875-00
902/3	Comprising of parts of 902/1 apparatus but with conical joints instead of spherical joints.	1425-00
902/4	Comprising of parts of 902/2 apparatus but with conical joints instead of spherical joints	1425-00

903 Micro Kjeldhal Nitrogen Distillation Apparatus, "LABCO", (Pregl. Parnas and Wagner Apparatus) Comprising of steam generation flask, Steam trap, Vaccum jacketed flask with funnel, Condenser tube silvered and receiving flask, Complete with heavy duty stand, clamps but without burner.

Cat. No.	Steam Generating Flask Cap. ml	Price/Piece Rs.
903/1	1000	13500-00
903/2	2000	14000-00
903/3	3000	15500-00
903/4	5000	18500-00
903/5	-do- glass tube condenser and 1000ml steam generating flask	6500-00
903/6	-do- with glass tube condenser and 2000 ml steam generating flask	6800-00

SPARE PARTS

904	Spare Silvered Tube for Cat. No. 903/1 and 903/2	6000-00
905	Spare Vacuum jacket for Cat. No. 903	1325-00
906	Parnas and Wagner Apparatus, "LABCO", for distillation of Ammonia from Kjeldhal digestion has been adopted to incorporate ground glass joints. Comprising of steam generating flask, Steam trap, Vaccum jacket, Funnel plug Leibig condenser 200mm, Joint clip S-13 and S-19 with stand and clamps	6250-00
907	Markham Semi- Micro Distillation Unit, "LABCO", Consisting of markham still body, funnel plug and Leibig condensor 300 mm long with conical joints.	2600-00
907/1	--- do --- but with spherical joints	2950-00
908	Nitrogen Distillation Apparatus, Micro Kemmer Hallet, "LABCO". Double stage Single Stage	7100-00 5100-00

909 Kjeldhal Absorption Traps, "LABCO".

Cat. No.	Description	Price/Piece Rs.
909/1	Comprising of Kjeldhal flask 500 ml lower chamber 250 ml and upper chamber with sintered disc.	3700-00
909/2	Comprising of similar parts but upper chamber without sintered disc.	3600-00

EXTRACTION APPARATUS

914 Soxhlet Extraction Apparatus Liquid/solid.

Cat. No.	Cap. of Extractor ml.	Socket Size of Extractor	Cone Size of Extractor	Flask Cap. R.B./F.B.ml.	Medium Wall (Heavy Type)
914/1	20	B 24	B 19	50	990-00
914/2	40	B 29	B 24	100	1100-00
914/3	60	B 34	B 24	150	1250-00
914/4	100	B 34	B 24	250	1275-00
914/5	100	B 40	B 24	250	1350-00
914/6	200	B 50	B 24	500	1850-00
914/7	400	B 50	B 24	1000	2650-00
914/8	600	B 50	B 24	2000	3250-00
914/9	1000	B 55	B 34	3000	5750-00
914/10	2000	B 55	B 34	5000	10500-00
914/11	3000	B 55	B 34	10000	14000-00

915 Spare Soxhlet Extractor, "LABCO".

Cat.No.	Cap. ml.	Socket	Cone	Medium Wall (Heavy Type)
915/1	20	B 24	B 19	400-00
915/2	40	B 29	B 24	490-00
915/3	60	B 34	B 24	620-00
915/4	100	B 34	B 24	640-00
915/5	100	B 40	B 24	700-00
915/6	200	B 50	B 24	970-00
915/7	400	B 50	B 24	1325-00
915/8	600	B 50	B 24	1515-00
915/9	1000	B 55	B 34	2350-00
915/10	2000	B 55	B 34	5850-00
915/11	3000	B 55	B 34	6750-00

916 Soxhlet Extraction Apparatus Complete with flat flange, "LABCO"

Cat. No.	Extractor ml. ml.	Flask Rs.	Price/Piece
916/1	600	2000	9600-00
916/2	1000	3000	13500-00
916/3	2000	5000	16000-00
916/4	3000	10000	19000-00

917 Soxhlet Extraction Apparatus, "LABCO", With Globular type extraction complete.

Cat. No.	Extractor ml. ml.	Flask Rs.	Price/Piece
917/1	1000	2000	7400-00
917/2	2000	3000	12000-00
917/3	3000	5000	15600-00
917/4	4000	10000	21800-00
917/5	6000	10000	32900-00

918 Soxhlet Fat Extraction Apparatus, "LABCO", Aspirator type complete with condenser.

Cat. No.	Extractor ml. ml.	Flask Rs.	Price/Piece
918/1	5000	5000	18500-00
918/2	10000	10000	32900-00
918/3	20000	20000	45000-00

918a Continuous Extraction Apparatus, "LABCO", Consist of Conical flask, Allihan Condenser, Middle delivery chamber and inner siphon tube

3850.00



914

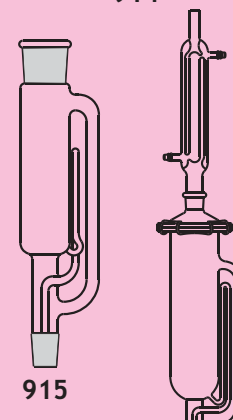

915

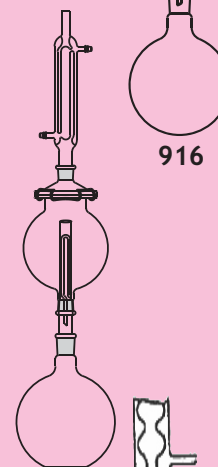

916

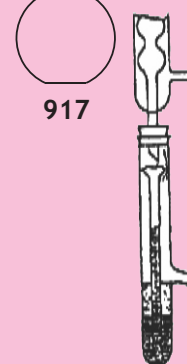

917

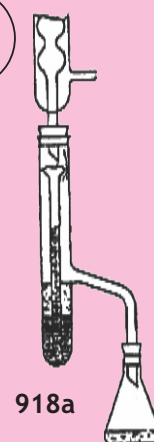

918a

CHROMATOGRAPHY APPARATUS

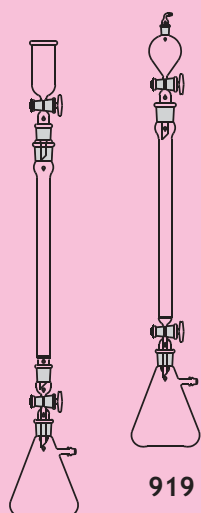

919 Chromatography Apparatus Semi Micro, "LABCO", Consisting of Funnel Reservoir 50ml with B 14 cone and socket, Column tube with tap 2 mm bore 100 mm effective length, with B 14 socket B 19 cone and fused sintered disc. Filtering flask 100 ml with B 19 socket, tamping rod 40cm long, Similar to Quickfit CR-1 1775-00

920 Chromatography Apparatus, "LABCO", Consisting of dropping funnel 250 ml with B 19 cone, Reduction adapter with B 19 socket B 24 cone. Column tube 2 cm dia 20 cm effective length with B 24 socket B 19 cone and fused sintered disc adapter with tap B 19 socket B 19 cone, Filtering flask 250 ml with B 24 socket tamping rod 50 cm long Similar to CR-2 2475-00

920 a Chromatography absorption assembly, "LABCO", Consisting of buchner flask 1 ltr. B-24 socket, Tap adapter B-24 cone B-19 socket, Cone adapter with filter disc B-19 and B-34 cones, Column 50 cm long with 1.5" pipe flange B-34 Socket, Flange adapter 1.5" B-24 socket, Metal flange with teflon gasket reservoir globular 5 ltr. B-24 cone, B-34 socket, cone adapter B-34 cone. 22500-00

920 b - do - with 90 cm. column with D-2" pipe flange. 24500-00

921 Chromatography Columns, "LABCO", with integral sintered disc without stopcock.

Cat. No.	Effective length Cmsmm	Disc Dia Rs.	Price/Piece
921/1	15	10	250-00
921/2	20	15	260-00
921/3	30	15	275-00
921/4	40	20	325-00
921/5	40	30	470-00
921/6	50	30	500-00
921/7	50	40	780-00
921/8	60	40	825-00
921/9	100	40	1100-00

922 Chromatography Columns, "LABCO", with integral sintered disc and stopcock.

Cat. No.	length cms	Disc Dia mm	Teflon Key Screw type stopcock	Glass Key stopcock
922/1	15	10	400-00	415-00
922/2	20	15	400-00	430-00
922/3	30	15	410-00	440-00
922/4	40	20	450-00	475-00
922/5	40	30	575-00	575-00
922/6	50	30	650-00	615-00
922/7	50	40	970-00	975-00
922/8	60	40	1000-00	1000-00
922/9	100	40	1300-00	1325-00

923 Plain Chromatography Absorption Columns, "LABCO", With stopcock.

Cat. No.	length cms	Tube dia mm	Teflon Key Screw type stopcock	Glass Key stopcock
923/1	20	10	185-00	210-00
923/2	30	15	220-00	230-00
923/3	50	20	320-00	360-00
923/4	60	25	375-00	400-00
923/5	60	40	680-00	590-00
923/6	100	50	1925-00	1500-00
923/7	100	60	2800-00	2400-00
923/8	115	100	---	5475-00
923/9	180	100	----	8150-00
923/10	180	115	-----	22500-00

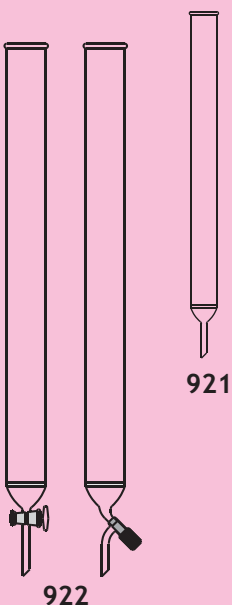

922

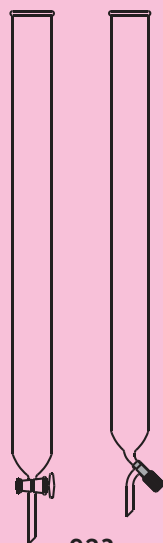

923

924 Chromatography Columns, "LABCO", with integral sintered disc and PTFE stopcock.

Cat. No.	Effective Length mmmm	Disc Dia. Rs.	Price/Piece
924/1	150	10	600-00
924/2	300	10	615-00
924/3	300	20	700-00
924/4	450	20	745-00
924/5	450	30	970-00
924/6	600	30	1000-00

925 Chromatography Column, "LABCO", Plain with PTFE key stopcocks

Cat. No.	Effective Length mmmm	Tube Dia. Rs.	Price/Piece
925/1	150	10	475-00
925/2	300	10	485-00
925/3	300	20	580-00
925/4	450	20	610-00
925/5	450	30	680-00
925/6	600	30	770-00
925/7	1000	40	1590-00
925/8	1150	100	7000-00

926 Plain Chromatography Absorption Columns, "LABCO", Without stopcock.

Cat. No.	Effective length Cms.mm.	Tube dia Rs.	Price/Piece
926/1	20	10	60-00
926/2	30	15	93-00
926/3	50	20	200-00
926/4	60	25	240-00
926/5	60	40	525-00
926/6	100	50	1200-00
926/7	115	100	4950-00
926/8	180	100	7990-00
926/9	180	115	24500-00

927 Chromatography Columns, "LABCO", With integral disc and tap with cone socket.

Cat. No.	Bore mm	Effect. length size mm	Socket size	Cone size	Price/Piece Rs.
927/1	10	100	B 14	B 19	690-00
927/2	10	200	B 14	B 19	700-00
927/3	10	300	B 14	B 19	715-00
927/4	20	300	B 24	B 19	750-00
927/5	20	400	B 24	B 19	760-00
927/6	20	400	B 24	B 24	775-00

928 Chromatography Columns, "LABCO", with integral sintered disc, Cone & Socket

Cat. No.	Bore mm	length mm	Socket size	Cone size	Price/Piece Rs.
928/1	20	200	B 24	B 19	440-00
928/2	20	300	B 24	B 19	460-00
928/3	20	400	B 24	B 19	485-00

(Any other size of Chromatography columns can also be supplied on request)



924



925



926



928



927

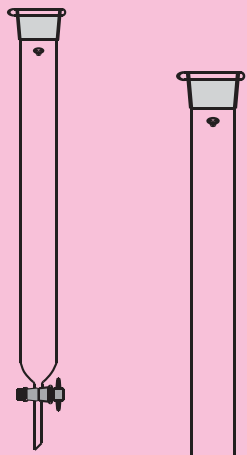

929



929A

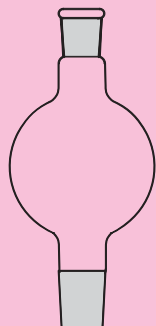

929B



930



931a/931b

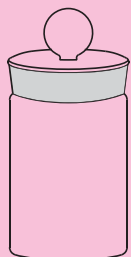

932



933

929 Chromatography Column, "LABCO", Plain with Socket & PTFE Stopcock.

Cat. No.	Effective Length mm	Outer Dia mm	Socket	Minimum Qty./Pack	Price/Piece Rs.
929/1	45	20	B 24	2	725-00
929/2	50	25	B 24	2	790-00
929/3	60	30	B 24	2	840-00
929/4	60	40	B 24	2	1325-00
929/5	100	50	B 24	2	1775-00
929/6	100	60	B 24	2	1950-00

929A Chromatography Column, "LABCO", with Integral sintered disc with Socket & PTFE Stopcock.

Cat. No.	Effective Length mm	Outer Dia mm	Socket	Minimum Qty./Pack	Price/Piece Rs.
929A/1	45	20	B 24	2	890-00
929A/2	45	30	B 24	2	1000-00
929A/3	60	30	B 24	2	1025-00
929A/4	60	40	B 24	2	1425-00
929A/5	100	40	B 24	2	1725-00

929B Reservoir for Chromatography Column, "LABCO", with Socket & Cone.

Cat. No.	Reservoir Capacity ml	Socket	Cone	Minimum Qty./Pack	Price/Piece Rs.
929B/1	100	B 24	B 24	2	325-00
929B/2	250	B 24	B 24	2	370-00
929B/3	500	B 24	B 24	2	470-00
929B/4	1000	B 24	B 24	2	700-00

(Any other size of Chromatography columns can also be supplied on request)

930 Hot Sealing machine for polythene bags, heavy quality size 12", "LABCO". 6300-00

931a Crimping Tools for sealing vial. Hand Operated vial sealing Machine for

Cat. No.	Size mm	Price/Piece Rs.
931a/1	13	9200-00
931a/2	20	9700-00

931b Decrimping Tools for sealing vial.

Cat. No.	Size mm	Price/Piece Rs.
931b/1	13	9200-00
931b/2	20	9700-00

932 TLC chamber with suitable stopper, cap-500ml, "LABCO", 1850-00

933 Instrument Cover (Plexi Glass), Made of imported Plexi Glass Sheet to cover Lab. Instrument. Front opening or open top opening. Small size 17900-00

933a --- do --- Medium size 21500-00

933b --- do --- Large size 33500-00

STOPCOCKS

940. Stopcock, Straight Bore, "LABCO".

Cat. No.	Description	Price/Piece	
		Bore 1-2 mm	Bore 3-4 mm
940/1	With Borosil Solid Plug, side Tube	115-00	200-00
940/2	With Borosil Solid Plug, side Capillary	125-00	205-00

941 Stopcock, Oblique Bore, "LABCO".

Cat. No.	Description	Price/Piece	
		Bore 1-2 mm	Bore 3-4 mm
941/1	With Borosil Solid Plug, Side Tube	150-00	230-00
941/2	With Borosil Solid Plug, Side Capillary	135-00	210-00

942 Stopcock, Three Way, T, Bore, "LABCO".

Cat. No.	Description	Price/Piece	
		Bore 1-2 mm	Bore 3-4 mm
942/1	With Borosil Solid Plug, Side Tube	235-00	275-00
942/2	With Borosil Solid Plug, Side Capillary	255-00	300-00

943 Stopcock, Three Way Double Oblique Bore, "LABCO".

Cat. No.	Description	Price/Piece	
		Bore 1-2 mm	Bore 3-4 mm
943/1	With Borosil Solid Plug, Side Tube	270-00	450-00
943/2	With Borosil Solid Plug, Side Capillary	280-00	525-00

944 Stopcock, Three Way Twin Bore, "LABCO", with Solid Plug

Cat. No.	Description	Price/Piece	
		Bore 1-2 mm	Bore 3-4 mm
944/1	With Side Tube	425-00	625-00
944/2	With Side Capillary	485-00	695-00

945 Stopcock Vertical Drip, "LABCO".

450-00

946 Stopcock for Burette, "LABCO".

Cat. No.	Description	Price/Piece Rs.
946/1	With Solid Borosil Plug	102-00
946/2	With Solid Borosil Plug & thread at back with cap for stopper gripping	305-00
946/3	With Hollow Borosil Plug	305-00
946/4	With PTFE Plug	385-00
946/5	Rotaflow, PTFE Key, screw type	102-00

947 Stopcock C Bore, "LABCO", Three Way

Cat. No.	Description	Price/Piece	
		Bore 1-2 mm	Bore 3-4 mm
947/1	With Borosil Solid Plug, Side Tube	300-00	390-00
947/2	With Borosil Solid Plug, Side Capillary	315-00	450-00

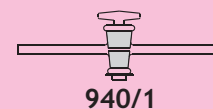

940/1

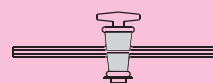

940/2



941/1



941/2

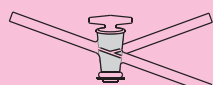

942/1

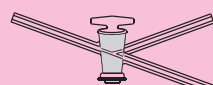

942/2



943/1

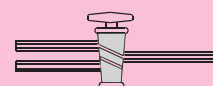

943/2



944

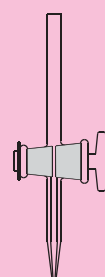

946/1

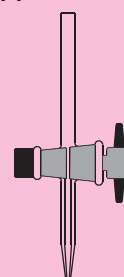

946/4

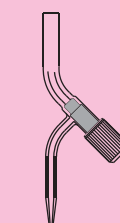

946/5

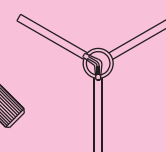

947/1

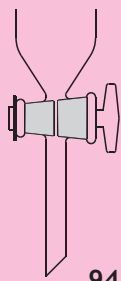

948

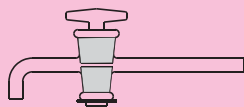

949/1

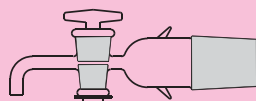

949/2/3

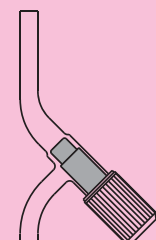

951

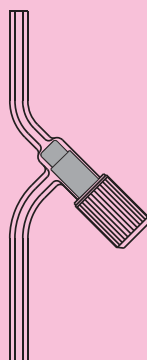

952

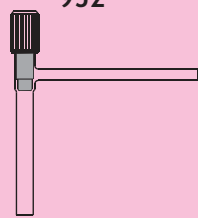

953

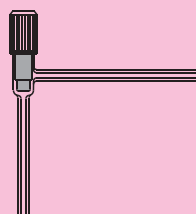

954

948 Stopcock for Separating Funnels.

Cat. No.	Bore mm.	Price/Piece Rs.
948/1	2	165-00
948/2	4	205-00
948/3	6	475-00
948/4	8	890-00
948/5	10	1400-00
948/6	12	1850-00

949 Stopcock for Aspirators 4 mm Bore.

Cat. No.		Price/Piece Rs.
949/1	Plain	155-00
949/2	With B 24 Cone	300-00
949/3	With B 29 Cone	345-00

950 Stopcock for Kipp's Apparatus, Bent.

300-00

SCREW TYPE, PTFE KEY STOPCOCKS

951 Stopcock screw type, PTFE Key, with Two Plain limbs.

Cat. No.	Limbs O.D. mm.	Price/Piece Rs.
951/1	8	99-00
951/2	10	205-00
951/3	12	280-00
951/4	15	650-00

952 Stopcock, Screw Type, PTFE Key, with two limbs, Capillary Bore 2 mm.

108-00

953 Stopcock Screw Type, PTFE, Key, with two Plain Limbs at Right Angle.

Cat. No.	Limbs O.D. mm	Price/Piece Rs.
953/1	8	110-00
953/2	10	220-00
953/3	12	315-00
953/4	15	875-00

954 Stopcock, Screw Type, PTFE key, with two limbs at Right Angle, Capillary Bore 2 mm.

140-00

PTFE (TEFLON) KEY STOPCOCKS

955 Stopcock Straight Bore with PTFE key, "LABCO".

Cat. No.	Key Bore mm.	Price/Piece Rs.
955/1	1	380-00
955/2	2	380-00
955/3	3	465-00
955/4	4	625-00
955/5	6	895-00
955/6	8	1690-00

956 Stopcock for Burette, Straight Bore, with PTFE key, "LABCO". 370-00

957 Stopcock for Burette, Double Oblique Bore, with PTFE key, "LABCO". 660-00

958 Stopcock for Separating Funnel 2 mm bore, with PTFE key, "LABCO". 490-00

958/1 -- do -- 4 mm. 640-00

959 Stopcock Oblique Bore, with PTFE key, "LABCO".

Cat. No.	Key Bore mm.	Price/Piece Rs.
959/1	2	1175-00
959/2	4	1475-00
959/3	6	2450-00

960 Stopcock T or Y Bore with PTFE key, "LABCO".

Cat. No.	Key Bore mm.	Price/Piece Rs.
960/1	2	880-00
960/2	4	1475-00

HIGH VACUUM STOPCOCKS

961 Stopcock Straight Bore, with hollow plug high Vacuum, "LABCO".

Cat. No.	Plug Bore mm.	Price/Piece Rs.
961/1	2	320-00
961/2	4	450-00
961/3	6	680-00
961/4	8	875-00
961/5	10	1550-00
961/6	12	1700-00
961/7	15	1950-00

962 Stopcock Single Oblique Bore, with hollow plug. High Vacuum, "LABCO",

Cat. No.	Plug Bore mm.	Price/Piece Rs.
962/1	2	350-00
962/2	4	480-00
962/3	6	740-00
962/4	8	940-00

963 Stopcock, Three Way Double Oblique Bore, High Vacuum, "LABCO",

Cat. No.	Plug Bore mm.	Price/Piece Rs.
963/1	2	540-00
963/2	4	650-00
963/3	6	1080-00

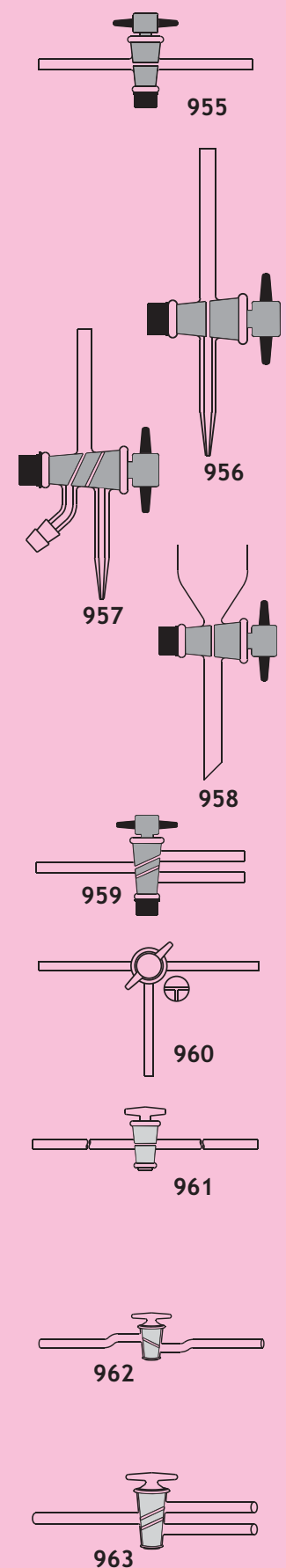



964

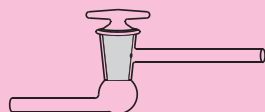

965

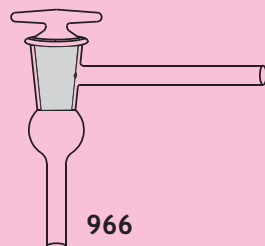

966

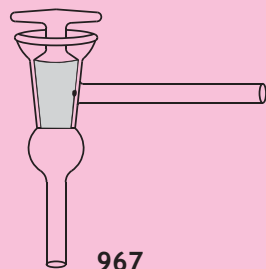

967

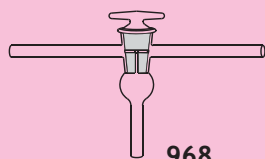

968



969

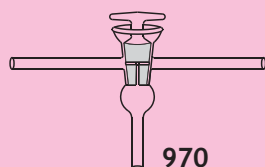

970

964 Stopcock, T or V Type, Hollow Plug, High Vacuum, "LABCO".

Cat. No.	Plug Bore mm.	Price/Piece Rs.
964/1	2	650-00
964/2	4	1075-00
964/3	6	1850-00
964/4	8	2350-00

965 Stopcock, L Type, Lower Limb bent at Right Angle, Hollow Plug, High Vacuum, "LABCO".

Cat. No.	Plug Bore mm	Price/Piece Rs.
965/1	2	270-00
965/2	4	340-00
965/3	6	430-00
965/4	8	950-00
965/5	10	1400-00

966 Stopcock, L Type, Lower Vertical, Hollow Plug, High Vacuum, "LABCO".

Cat. No.	Plug Bore mm.	Price/Piece Rs.
966/1	2	300-00
966/2	4	375-00
966/3	6	475-00
966/4	8	850-00
966/5	10	1150-00

967 Stopcock, L Type, Two Limb with Mercury Cup Lower Limb Vertical, Hollow Plug, High Vacuum, "LABCO".

Cat. No.	Plug Bore mm	Price/Piece Rs.
967/1	2	525-00
967/2	4	625-00
967/3	6	725-00
967/4	8	1550-00
967/5	10	1850-00

968 Stopcock, L Type, Three Limb, Hollow Plug, High Vacuum, "LABCO".

Cat. No	Plug Bore mm	Price/Piece Rs.
968/1	2	675-00
968/2	4	1200-00
968/3	6	1875-00

969 Stopcock, Mercury Cup, Two Limb, Hollow Plug, High Vacuum, "LABCO".

Cat. No.	Plug Bore	Price/Piece Rs.
969/1	2	800-00
969/2	4	1400-00

970 Stopcock, Mercury Cup, Three limb, Hollow Plug, High Vacuum, "LABCO".

Cat. No.	Plug Bore mm	Price/Piece Rs.
970/1	1	900-00
970/2	2	1450-00

BEAKERS

971 Beakers Low form, with spout, graduated.

Cat. No.	Capacity ml.Qty./Pack	Min. Rs.	Price/Piece
971/1	5	20	68-00
971/2	10	20	68-00
971/3	25	20	63-00
971/4	50	20	54-00
971/5	100	20	59-00
971/6	150	20	65-00
971/7	250	20	72-00
971/8	500	12	115-00
971/9	600	12	148-00
971/10	1000	12	235-00
971/11	2000	4	640-00
971/12	5000	2	1825-00
971/13	10000	1	5750-00

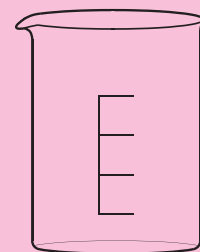

971

971M Amber Colour Beakers Low Form, "LABCO", with spout, Graduated

Cat No.	Capacity mlQty./Pack	Minimum Rs.	Price/Piece
971M/1	50	10	150-00
971M/2	100	10	210-00
971M/3	150	10	230-00
971M/4	250	6	260-00
971M/5	500	6	415-00

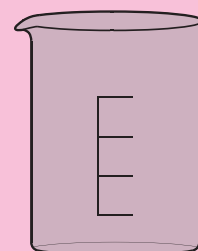

971M

971a Beakers, "LABCO", Tall form with spout.

Cat. No.	Capacity ml.Qty./Pack	Minimum Rs.	Price/Piece
971a/1	50	20	93-00
971a/2	100	20	108-00
971a/3	150	20	118-00
971a/4	250	12	124-00
971a/5	500	12	165-00
971a/6	1000	12	325-00

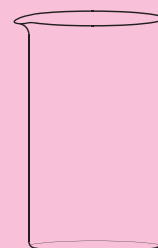

971a

971b Beakers, "LABCO", Tall form without spout.

Cat. No.	Capacity ml.Qty./Pack	Minimum Rs.	Price/Piece
971b/1	50	20	93-00
971b/2	100	20	108-00
971b/3	150	20	118-00
971b/4	250	12	124-00
971b/5	500	12	165-00
971b/6	1000	12	325-00

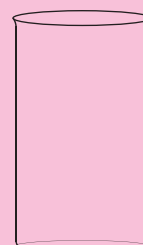

971b

971c Beaker Philips, Conical with spout, "LABCO".

Cat. No.	Capacity ml.Qty./Pack	Minimum Rs.	Price/Piece
971c/1	250	2	400-00
971c/2	500	2	520-00



971f

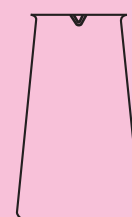

971c

971d Beaker for Karl Fisher Apparatus with standard Joints "LABCO".

971e Beaker for Karl Fisher Apparatus With Teflon sheet top "LABCO"

971f Cleaning Brushes for Beakers, made of Nylon Bristle (Pack of 6pcs)

BOTTLES

972. Weighing Bottles, "LABCO", with interchangeable stopper.

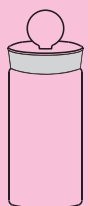

972



972

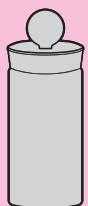

973M



973M

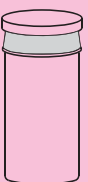

974



975

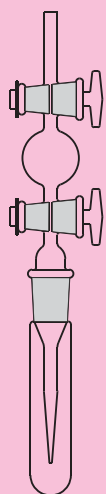

977

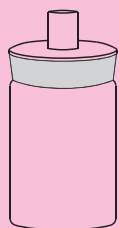

976

Cat. No	O.D.x HT. mm ml.	Capacity Rs.	Price/Piece
972/1 Squat form	40 x 30	20	235-00
972/2	50 x 25	20	285-00
972/3	50 x 35	35	295-00
972/4	50 x 50	50	320-00
972/5	60 x 40	40	380-00
972/6 Tall form	20 x 40	5	130-00
972/7	25 x 50	15	145-00
972/8	30 x 60	25	175-00
972/9	40 x 80	60	270-00

973M Amber Colour Weighing Bottles "LABCO", with interchangeable stopper.

Cat. No	O.D.x HT. mm ml.	Capacity Rs.	Price/Piece
973M/1 Squat form	40 x 30	20	335-00
973M/2	50 x 25	20	400-00
973M/3	50 x 35	35	425-00
973M/4	50 x 50	50	450-00
973M/5	60 x 40	40	530-00
973M/6 Tall form	20 x 40	5	190-00
973M/7	25 x 50	15	210-00
973M/8	30 x 60	25	270-00
973M/9	40 x 80	60	400-00

974 Weighing Bottles, "LABCO", Tall Form, Cap Type.

Cat. No	O.D.x HT. mm ml.	Capacity Rs.	Price/Piece
974/1	18 x 40	7	170-00
974/2	28 x 50	25	200-00
974/3	38 x 60	55	300-00
974/4	45 x 80	100	335-00

975 Weighing Bottles, "LABCO", Squat Form, Cap Type.

Cat. No	O.D.x HT. mm ml.	Capacity Rs.	Price/Piece
975/1	38 x 30	25	295-00
975/2	45 x 30	45	325-00

976 Bottles Wide Mouth, "LABCO", with interchangeable stopper for 15 mm. Suba Seals.

Cat. No	HT.x O.D. mm ml.	Capacity Rs.	Price/Piece
976/1	60 x 30	25	215-00
976/2	80 x 40	60	285-00
976/3	80 x 50	100	350-00
976/4	100 x 60	250	525-00
976/5	135 x 75	500	840-00
976/6	180 x 90	1000	1550-00

977 Weighing Bottle Lunge's "LABCO", for weighing Corrosive liquids 570-00

978 Specific Gravity Bottles, "LABCO", Ground inter changeable capillary bore Teflon stopper, Class A with Works Certificate.

Cat. No.	Capacity ml.	Price/Piece Rs.
978/1	5	270-00
978/2	10	310-00
978/3	20	315-00
978/4	25	320-00
978/5	50	340-00
978/6	100	530-00

978L Specific Gravity Bottles, "LABCO", Capacity Bore Interchangeable Teflon stopper, Class A, With NABL Works Certificate.

Cat. No.	Capacity ml	Tolerance ± ml	Minimum Qty./Pack	Price/Piece Rs.
978L/1	5	0.1	2	490-00
978L/2	10	0.3	2	560-00
978L/3	20	0.8	2	575-00
978L/4	25	0.8	2	575-00
978L/5	50	1.0	2	630-00
978L/6	100	2.0	2	975-00

979 Specific Gravity Bottles, "LABCO", Ground in capillary stopper.

Cat. No.	Capacity ml.	Price/Piece Rs.
979/1	5	165-00
979/2	10	180-00
979/3	20	190-00
979/4	25	200-00
979/5	50	210-00
979/6	100	250-00

980 Specific Gravity Bottles, "LABCO", Class 'A' with Ground in thermometer range 0 to 50°C with works certificates (Pyknometer)

Cat. No.	Capacity ml.	Price/Piece Rs.
980/1	10	740-00
980/2	25	770-00
980/3	50	800-00

981. Jar Rectangular, "LABCO", Museum, Borosilicate Glass with cover.

Cat. No.	Length mm.	Breadth mm.	Height mm.	Price/Piece Rs.
981/1	215	100	140	1525-00
981/2	140	140	220	1600-00
981/3	170	130	210	1640-00
981/4	225	125	225	2400-00
981/5	250	150	250	3100-00

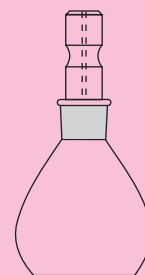

978

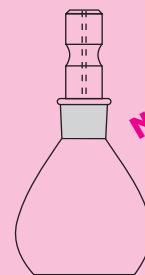

978 L



979

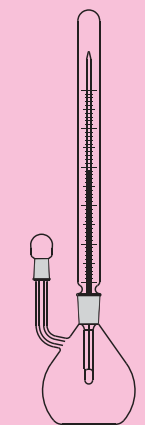

980

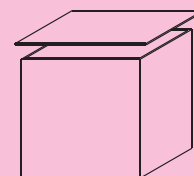

981

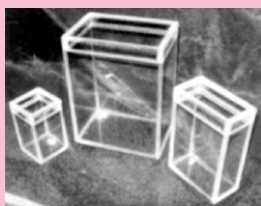

982

982. Jar Rectangular, "LABCO", Museum. Made from clear Imported plexi glass acrylic sheet. Joints are Tongue & groove type & are chemically welded, leakproof with cover & knob.

Cat. No.	Length mm.	Breadth mm.	Height mm.	Price/Piece Rs.
982/1	100	50	150	1080-00
982/2	150	150	150	1350-00
982/3	120	100	200	1300-00
982/4	125	125	200	1350-00
982/5	225	125	225	2200-00
982/6	250	150	250	2500-00
982/7	150	100	360	3100-00
982/8	280	230	380	6900-00

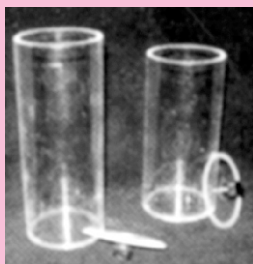

983

983 Jar, Cylindrical, Museum, "LABCO", Cylindrical Jar are Made from clear Imported plexi glass acrylic pipe. bottom chemically welded, leakproof with cover & knob.

Cat. No.	O.D. X Ht. (mm)	Price/Piece Rs.
983/1	50 X 100	1100-00
983/2	75 X 100	1200-00
983/3	100 x 150	1350-00
983/4	100 x 200	1550-00
983/5	125 x 300	2700-00

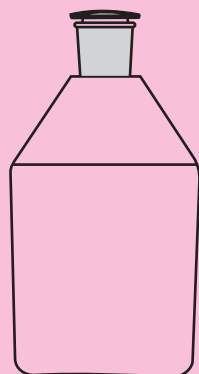

984

984 Reagent Bottles, "LABCO", Narrow Mouth, with interchangeable hexagonal flat head hollow Stopper.

Cat. No.	Capacity ml. Qty./Pack	Min. Rs.	Price/Piece
984/1	30	6	175-00
984/2	60	6	210-00
984/3	125	6	280-00
984/4	250	2	310-00
984/5	500	2	430-00
984/6	1000	1	600-00
984/7	2000	1	1050-00
984/8	5000	1	5700-00
984/9	10000	1	9900-00

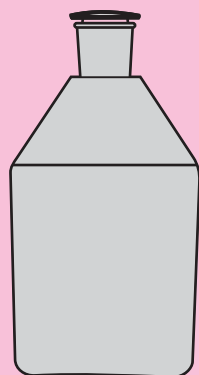

984 M

984M Amber Colour Reagent Bottles, "LABCO", Narrow Mouth with Interchangeable flat head, Solid Glass Stopper

Cat. No.	Capacity ml	Stopper Size	Minimum Qty./Pack	Price/Piece Rs.
984M/1	30	B 14	12	290-00
984M/2	60	B 14	12	385-00
984M/3	125	B 19	12	415-00
984M/4	250	B 19	12	525-00
984M/5	500	B 24	12	690-00
984M/6	1000	B 29	6	1000-00
984M/7	2000	B 34	6	1750-00

985 Reagent Bottles, "LABCO", Wide Mouth, with interchangeable hollow Stopper.

Cat. No.	Capacity ml. Qty. /Pack	Min. Rs.	Price/Piece
985/1	30	6	190-00
985/2	60	6	230-00
985/3	125	6	360-00
985/4	250	2	570-00
985/5	500	2	730-00
985/6	1000	1	1100-00
985/7	2000	1	1460-00

985a Bottle Wide mouth, "LABCO", with polypropylene Blue screw cap and pouring ring, repeatedly autoclaveable, Graduated Moulded

Cat. No.	Capacity ml.	Transparent Rs.
985a/1	10	190-00
985a/2	* 30	250-00
985a/3	* 60	290-00
985a/4	100	310-00
985a/5	250	345-00
985a/6	500	430-00
985a/7	1000	585-00
985a/8	2000	945-00
985a/9	5000	5500-00
985a/10	10000	8400-00
985a/11	20000	14900-00

(* Without Pouring Ring)

986 Bottle Wide mouth, "LABCO", with polypropylene Blue screw cap, repeatedly autoclaveable, Graduated. Blown

Cat. No.	Capacity ml. Qty. /Pack	Min. Rs.	Price/Piece
986/1	30	6	210-00
986/2	60	6	240-00
986/3	100	6	285-00
986/4	250	2	310-00
986/5	500	2	335-00
986/6	1000	1	540-00
986/7	2000	1	850-00

987 B.O.D. Bottles, with interchangeable stopper

Cat. No.	Capacity ml. Qty. /Pack	Min. Rs.	Price/Piece
987/1	60	2	290-00
987/2	125	2	350-00
987/3	300	2	450-00

988 Dropping Bottles, "LABCO", fitted with ground in interchangeable stopper and rubber teat.

Cat. No.	Capacity ml. Qty. /Pack	Min. Rs.	Price/Piece
988/1	30	6	235-00
988/2	60	6	270-00
988/3	125	6	350-00
988/4	250	2	460-00

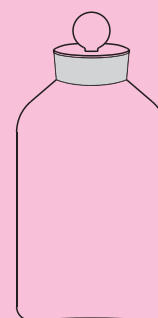

985

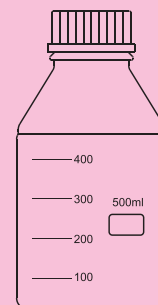

985a

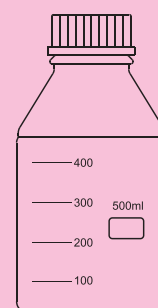

986



987

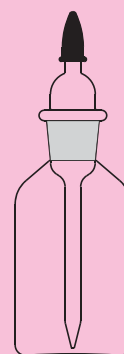

988

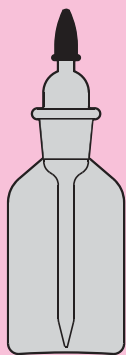

988M

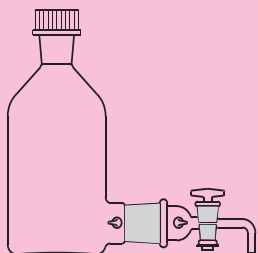

989

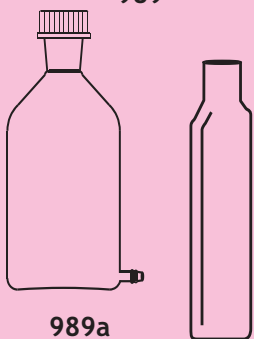

989a

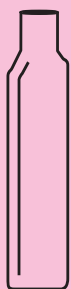

989b

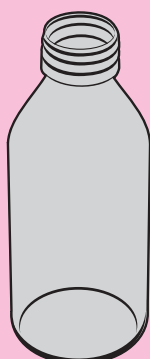

990



991

988M Amber Colour Dropping Bottles, "LABCO", with Interchangeable stopper & rubber teat.

Cat. No.	Capacity ml. Qty./Pack	Min. Rs.	Price/Piece
988M/1	30	12	365-00
988M/2	60	12	490-00
988M/3	125	12	540-00
988M/4	250	12	700-00

989 Bottles Aspirator, "LABCO", with interchangeable stopper, Screw type PTFE key stopcock with interchangeable joint.

Cat. No.	Capacity ml.	Price/Piece Rs.
989/1	1000	1830-00
989/2	2000	2100-00
989/3	5000	7700-00
989/4	10000	10900-00
989/5	20000	15900-00

989a Bottle Aspirator, "LABCO", with screw cap & tubulation

Cat. No.	Capacity ml.	Price/Piece Rs.
989a/1	250	340-00
989a/2	500	440-00
989a/3	1000	715-00
989a/4	2000	1100-00

989b Roux, Culture, off-set Neck, "LABCO"

Cat. No.	Capacity ml.	Neck I.D. mm.	Approx. Height mm.	Approx. Cross Sec. mm	Price/piece Rs.
989b/1	1000	26	255	120 x 55	1400-00

**BOTTLES FOR GENERAL PURPOSE
(ORDINARY USP TYPE III)**

990 Amber Colour Bottles, "LABCO", Narrow mouth with screw cap of either PVC or Aluminium

Cat. No.	Capacity ml	Mouth ID mm	Minimum Qty./Pack	Price/Pack Rs.
990/1	10	22	576	5760-00
990/2	20	25	420	5250-00
990/3	60	25	242	4100-00
990/4	100	25	90	1800-00
990/5	210	25	60	1920-00
990/6	300	25	46	2100-00
990/7	485	25	32	1600-00

991 Amber Colour Bottles, "LABCO", wide mouth with screw cap of either PVC or Aluminium

Cat. No.	Capacity ml	Mouth ID mm	Minimum Qty./Pack	Price/Pack Rs.
991/1	45	31.5	220	3500-00
991/2	456	53	48	2400-00

992 JAR, "LABCO", Wide Mouth, Transparent with screw cap either PVC or Metallic

Cat. No.	Capacity ml	Mouth ID mm	Minimum Qty./Pack	Price/Pack Rs.
992/1	31	43	268	5100-00
992/2	125	53	100	2500-00
992/3	280	63	56	2550-00
992/4	350	82	56	2500-00
992/5	800	82	23	2140-00



992

992a Liquid Storage Bottles, "LABCO", with screw cap either PVC or Metallic

Cat. No.	Capacity ml	Mouth ID mm	Minimum Qty./Pack	Price/Pack Rs.
992a/1	300	43	48	2140-00
992a/2	500	43	35	2240-00
992a/3	1000	43	20	2200-00



992a

993 Vials Transparent (USP Type III Glass)

Cat. No.	Capacity ml. Pcs	Packing Rs.	Price/Pack
993/1	7.5	1008	4650-00
993/2	10	756	5250-00
993/3	20	420	4650-00
993/4	30	396	4475-00
993/5	50	220	4860-00
993/6	100	144	3775-00



993

Note : Price for Rubber septa and Alluminium cap extra. Rs. 6.50 for 7.5ml. to 100ml.,

993M Vials Amber Coloured (USP Type III Glass)

Cat. No.	Capacity ml. Pcs	Packing Rs.	Price/Pack
993M/1	7.5	756	6125-00
993M/2	10	744	7440-00
993M/3	20	420	6050-00
993M/4	30	420	6300-00
993M/5	50	220	4950-00
993M/6	100	144	4390-00

Note : Price for Rubber septa and Alluminium cap extra. Rs. 6.50 for 7.5ml. to 100ml.,

993b Media Bottle (Jam Bottle) with PP Cap Autoclaveable

Cat. No.	Capacity ml. Pcs	Packing	Rate/Pack
993b/1	200	100	2697-00
993b/2	400	64	2430-00

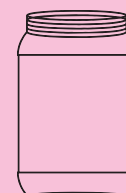

993b

994 Woulf Bottles, "LABCO", with joint necks. (Boro 3.3 Exp. Glass)

Cat. No.	Capacity ml.	Price/Piece Rs.
994/1	250	460-00
994/2	500	540-00

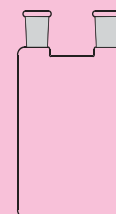

994

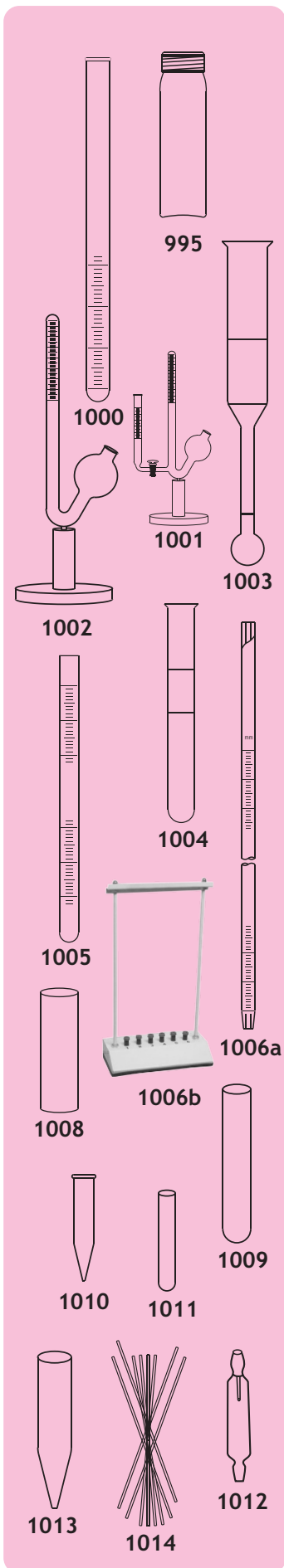

995 Mac-Cartney Bottles, "LABCO", Complete with Aluminium Cap. (Boro 3.3 Exp. Glass)

Cat. No.	Capacity ml. Qty./Pack	Min. Rs.	Price/Piece
995/1	15	25	58-00
995/2	30	25	64-00
995/3	60	25	84-00
995/4	100	25	250-00

996 VDRL Antigen Bottles with glass stopper 240-00

CLINICAL LABORATORY APPARATUS

1000 Albuinometer, "LABCO", Esbach's incase 260-00

1001 Ureometer Doremus, "LABCO", with stopcock for rapid determination in urine 570-00

1002 Ureometer Doremus, "LABCO", without stopcock. 400-00

1003 Blood Sugar Tubes, "LABCO", Folin Wu, as per I.S. 3740:1966, Capacity 25ml., marked at 4 ml, 12.5ml. and 25 ml. 190-00

1004 Tubes, Digestion, "LABCO", Folin-Wu, marked at 35 ml. and 50 ml. 25mm O.D., 200 mm. length. 72-00

1005 Wintrobe Tubes, "LABCO", 100mm. graduated. 40-00

1006a E.S.R. Tube, 200 mm. graduated, 300 mm. long. 70-00

1006b E.S.R. Stand for 6 tubes 680-00

1007 Tube for Kahn and Wasserman test, 75x12mm. 6-90

1008 Kahn's Antigen Dilution Tube, "LABCO", 55x18mm. Flat bottom. 18-00

1009 Wasserman Tube, "LABCO", Rimless.

Cat. No.	Size mm.	Price/Piece Rs.
1009/1	50 x 10	6-90
1009/2	75 x 10	6-80

1010 Dreyer's Agglutination Tube, Conical bottom 14-00

1011 Durham Tube, "LABCO".

Cat. No.	Size mm.	Min. Qty./Pack	Price/Piece Rs.
1011/1	25 x 6	100	5-00
1011/2	37 x 6	100	5-40
1011/3	50 x 6	100	6-25

1012 Murphy Drip, "LABCO". 45-00

1013 Widal Tube Conical Bottom, "LABCO". 18-00

1014 Co-Agulation Tubes (melting point tube) capillary length 100mm. one end sealed (Pack of 100 Pieces) 100-00

1014/1 ---- do ---- Same as above both side opened 104-00

1015	Glass Spreader, "LABCO".																			
1015/1	Spreader 'L' shape	110-00																		
1015/2	Spreader Lower portion at angle	150-00																		
1015/3	Spreader Triangular 50 mm	200-00																		
1018	Counting Chambers Double Ruling improved BRIGHTLINE	2500-00																		
1019	Haemocytometer in box with counting chamber, cover glasses, R .B .C. and W.B.C. Pipettes with rubber suction tubing and mouth piece.	2900-00																		
1020	R.B.C. Pipette with suction tube and mouth piece	140-00																		
1021	W.B.C. Pipette with suction tube and mouth piece	140-00																		
1022	Stage Micrometer Imported	2200-00																		
1023	Ocular Micrometer Disc Imported	1950-00																		
1023b	Haemoglobin tube Indian, "LABCO".	120-00 Ea																		
	..do... Imported	340-00 Ea																		
1023 c	Haemoglobin Pipette Indian, "LABCO".	120-00 Ea																		
	..do... Imported	340-00 Ea																		
1023d	Haemometer tube. "LABCO".	90-00 Ea																		
1023e	Haemometer complete set	1150-00 Ea																		
1023f	Disposable Syringes																			
	<table border="1"> <thead> <tr> <th>Cat. No.</th> <th>Capacity ml</th> <th>Price/Piece Rs.</th> </tr> </thead> <tbody> <tr> <td>1023f/1</td> <td>1</td> <td>14-50</td> </tr> <tr> <td>1023f/2</td> <td>2</td> <td>14-00</td> </tr> <tr> <td>1023f/3</td> <td>5</td> <td>13-00</td> </tr> <tr> <td>1023f/4</td> <td>10</td> <td>16-50</td> </tr> <tr> <td>1023f/5</td> <td>20</td> <td>30-00</td> </tr> </tbody> </table>	Cat. No.	Capacity ml	Price/Piece Rs.	1023f/1	1	14-50	1023f/2	2	14-00	1023f/3	5	13-00	1023f/4	10	16-50	1023f/5	20	30-00	
Cat. No.	Capacity ml	Price/Piece Rs.																		
1023f/1	1	14-50																		
1023f/2	2	14-00																		
1023f/3	5	13-00																		
1023f/4	10	16-50																		
1023f/5	20	30-00																		
1023g	Syringe Stand made of imported plexi glass sheet vertical standing type	6000-00																		
1023h	-- do -- slanting holding type	8500-00																		
1023i	Haemoglobinometer (Sahli's) with unbreakable square H.B. tube	1350-00																		
1023j	Chloroscope (Chlorine test kit)	1950-00																		

CANNULAE

1027	Aeration Tube (Oxygen Tube).	135-00
1028	-do- with platinum tip.	340-00
1029	Warming coil Horizontal or Vertical.	475-00
1030	Organ Tube with side tube.	250-00

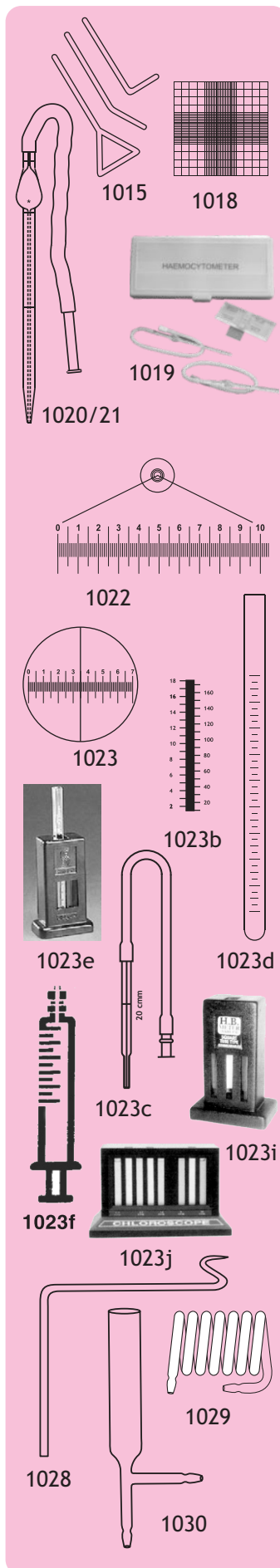

MICROSCOPIC SLIDES & COVER GLASSES

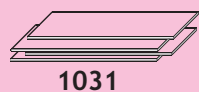

1031

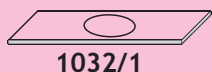

1032/1



1032/3



1033/1

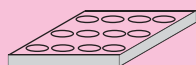

1033/4



1034

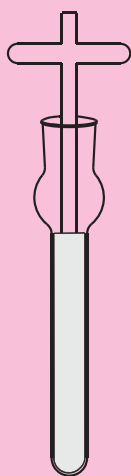

1035



1036

- 1031 Plain Microscopic Slide Make, "LABCO",** Manufactured from the best selected glass sheets, optically flat glass for microscopic use, ground polished edges, clean and ready for use. These micro slides are made as per ISI specification. Size 75mm x 25mm (Pack of 50 Pcs)

Cat. No.	Quality/Thickness	Price/Pack
1031/1	Regular	1.30mm 108-00

- 1032 Micro concavity Slides Make, "LABCO",** Manufactured from the best selected glass sheets, optically flat glass for microscopic use, ground polished edges, clean and ready for use. Size 76mm x 26mm + 1.4mm (Pack of 10 Nos.)

Cat. No.	Type	Price/Pack
1032/1	Single Concavity	78-00
1032/2	Double Concavity	94-00
1032/3	Triple Concavity	112-00

- 1033 Microscopic VDRL concavity Slides Make, "LABCO",** A noncorrosive frosted glass slide 75 x 56 x 3mm with bevelled polished edges having several concavities, used for Serodiagnostic tests. The diameter of each concavity is 16mm and 1.75mm deep

Cat. No.	Type	Price/Piece Rs.
1033/1	6 Concavities	105-00
1033/2	8 Concavities	105-00
1033/3	10 Concavities	105-00
1033/4	12 Concavities	105-00

- 1034 Micro Cover Glasses, "LABCO",** Micro cover glasses are made from both imported glass and Indian glass. These are optically flat and free from waviness. This product is packed in controlled condition, clean & ready for use. These cover glasses are made as per ISI specification. (Per pkt of 10gms)

Cat. No.	Type Size	(Rs/Pack.)
1034/1	Square 18mm x 18mm	60-00
1034/2	Square 22mm x 22mm	68-00
1034/3	Circular 18mm	60-00
1034/4	Circular 22mm	72-00

TISSUE HOMOGENISERS

- 1035 Tissue Grinders Ten Broeck Type, "LABCO".**

Cat.No.	Vessel Length mm.	Vessel O.D. mm.	Capacity Approx.ml.	Price/Piece Rs.
1035/1	100	13	2	480-00
1035/2	130	16	7	525-00
1035/3	150	18	15	560-00
1035/4	210	25	40	750-00

- 1036 Tissue Grinders, "LABCO",** Homogenisers.

Cat.No.	Vessel length mmmm.	Vessel O.D. Rs.	Price/Piece
1036/1	100	13	275-00
1036/2	150	16	350-00
1036/3	150	18	400-00
1036/4	200	18	475-00

1037 Teflon Pestle Tissue Homogenisers, "LABCO", having stainless steel rod, replaceable vessel of Borosil glass for the preparation of tissue homogenates.

Cat.No.	Capacity ml.	Price/Piece Rs.
1037/1	5	460-00
1037/2	10	460-00
1037/3	30	705-00
1037/4	50	985-00
1037/5	100	1170-00

1038 Spare Glass Vessel, "LABCO", for Cat. No. 1037.

Cat. No.	Capacity ml.	Price/Piece Rs.
1038/1	5	210-00
1038/2	10	220-00
1038/3	30	310-00
1038/4	50	400-00
1038/5	100	465-00

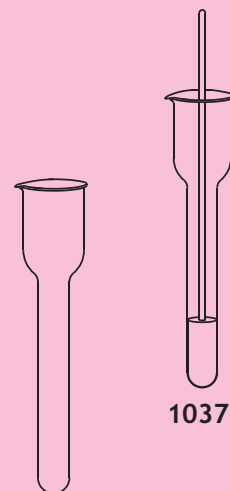

1038

1037

CONWAY DIFFUSION UNIT

1039 Conway Type Diffusion Unit, "LABCO", with cover.

Cat. No.	Outer Dish O.D. x Ht. mm.mm.	Inner Chamber O.D. x Ht.	Price/Piece Rs.
1039/1	50 x 17	25 x 5	410-00
1039/2	80 x 17	35 x 5	430-00
1039/3	100 x 17	40 x 5	640-00



1039

PETRI DISHES

1040 Dishes Culture, Petri, "LABCO", Borosilicate Glass.

Cat. No.	O.D. X HT. (mm)Qty./Pack	Min. Rs.	Price/piece
1040/1	50 x 17	10	118-00
1040/2	80 x 17	10	140-00
1040/3	100 x 17	10	170-00
1040/4	150 x 20	5	575-00
1040/5	200 x 20	5	1300-00



1040

1041 Petri Dishes 100x15mm Imported (Extra Crystlline)

150-00

1042 Amber Colour Petri Dishes, Bore 3.3 expansion Glass

Cat. No.	O.D X Ht. (Aprox.)	Minimum Qty./Pack	Price/Piece Rs.
1042/1	50 x 17	10	260-00
1042/2	80 x 17	10	380-00
1042/3	100 x 17	10	410-00



1042

CULTURE FLASKS

1045 Trypsinising Flasks, "LABCO", for Culture.

Cat. No.	Flask Capacity ml.	Price/Piece Rs.
1045/1	25	170-00
1045/2	50	300-00
1045/3	100	275-00
1045/4	250	415-00
1045/5	500	455-00
1045/6	1000	825-00

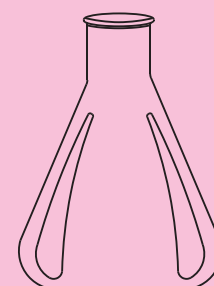

1045

AMPOULES

1048 Ampoules Freeze Drying, "LABCO", Round/Flat Bottom

Cat. No.	Capacity ml.	Neck O.D. mm.	Overall Length mm.	Min. Qty./Pack	Price/piece Rs.
1048/1	1	7	80	50	13-50
1048/2	2	8	140	50	22-00
1048/3	3	8	163	50	23-00
1048/4	5	8	167	50	25-00
1048/5	10	8	180	50	29-00
1048/6	15	8	180	50	35-00
1048/7	20	8	195	50	54-00
1048/8	25	8	200	50	55-00
1048/9	50	8	230	50	88-00
1048/10	100	15	240	50	127-00

1049 Ampoules Freeze Drying, "LABCO", Round Bottom, with firing-off constriction.

Cat. No.	Capacity ml.	Neck O.D. mm.	Overall length mm.	Min. Qty/Pack	Price/Piece Rs.
1049/1	10	8	180	50	40-00
1049/2	20	8	195	50	60-00
1049/3	25	8	200	50	69-00
1049/4	50	8	230	50	110-00
1049/5	100	15	240	50	160-00

1050 Ampoules Freeze Drying, "LABCO", Flat Bottom with firing off Constriction.

Cat. No.	Capacity ml.	Neck O.D. mm.	Overall length mm.	Min. Qty./Pack	Price/Piece Rs.
1050/1	1	7	80	50	30-00
1050/2	2	8	140	50	42-00
1050/3	3	8	163	50	48-00
1050/4	5	8	167	50	62-00
1050/5	10	8	180	50	78-00
1050/6	25	8	200	50	162-00

1051 Ampoules Freeze Drying, "LABCO", Tubular.

Cat.No.	Capacity ml.	Neck O.D. mm.	Overall Length mm.	Min. Qty./Pack	Price/Piece Rs.
1051/1	0.5	6	112	50	7-75
1051/2	1.0	7	127	50	8-90
1051/3	2.0	8	147	50	9-85
1051/4	3.0	10	147	50	12-80
1051/5	4.0	10	170	50	14-75



1048



1049



1050



1051

GAS APPARATUS

1052 Gas Desorber, "LABCO", 6400-00

1053 Impinger, "LABCO", graduated for sampling small gas volumes as per standard specification.

Cat. No.	Capacity ml.	Price/Piece Rs.
1053/1	35	330-00
1053/2	50	365-00
1053/3	80	435-00
1053/4	150	550-00
1053/5	275	740-00

1053M Amber Coloured Impinger, "LABCO", graduated for sampling small gas volumes as per standard specification.

Cat. No.	Capacity ml.	Price/Piece Rs.
1053M/1	35	670-00
1053M/2	50	740-00
1053M/3	80	890-00
1053M/4	150	1175-00
1053M/5	275	1575-00

1054 Large Size Impinger, "LABCO", Used in an Impinger train to Collect gases and particles from air and gases. Cap. 500 ml. graduated at 100 ml, 250 ml. and 500 ml. 1550-00

1055 Impinger Bubbler Type, "LABCO", Graduated in 5 ml interval with standard joint and sintered disc for measurement of air pollutants.

Cat. No.	Capacity ml. microns	Pore size Rs	Price/Piece
1055/1	35	170-200	510-00
1055/2	35	90-150	510-00
1055/3	35	49-90	510-00

1056 Calcium Chloride Tube, "LABCO", Straight or bent.

1056/1	with one bulb	48-00
1056/2	with two bulbs	54-00

1057 Calcium Chloride Tube, "LABCO", U shape.

Cat. No.	Size mm.	Price/piece Rs.
1057/1	100 x 12	90-00
1057/2	125 x 15	99-00
1057/3	150 x 18	124-00

1058 Calcium Chloride Tube, "LABCO", U shape with side tube.

Cat. No.	Size mm.	Price/Piece Rs.
1058/1	100 x 12	135-00
1058/2	125 x 15	148-00
1058/3	150 x 18	164-00

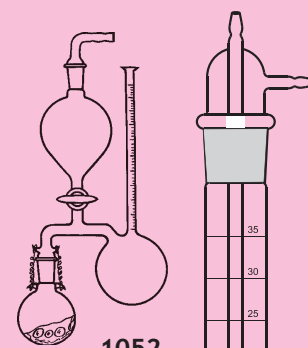

1052

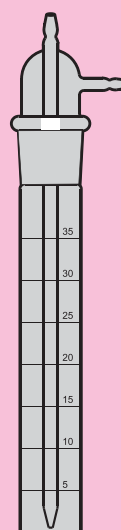

1053

1053a

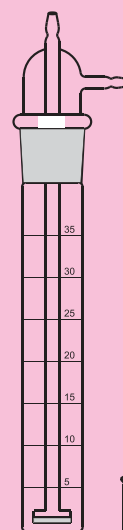

1055

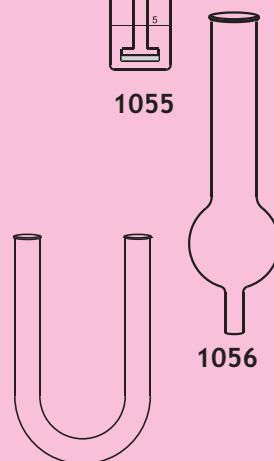

1056

1057

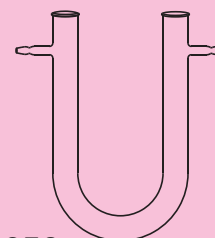

1058

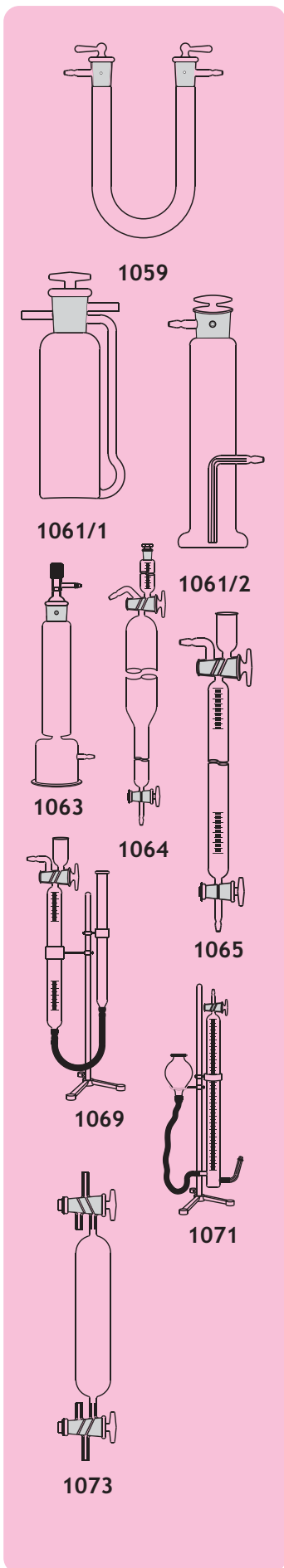

1059 Calcium Chloride Tube, "LABCO", U shape with side tube and interchangeable stopper.

Cat. No.	Size mm.	Price/Piece Rs.
1059/1	100 x 12	380-00
1059/2	125 x 15	390-00
1059/3	150 x 18	425-00

1061 Absorption Bulbs, "LABCO",

Cat. No.	Size mm.	Price/Piece Rs.
1061/1	Nesbitt	575-00
1061/2	Midvale	500-00

1063 Calcium Chloride tower, "LABCO", Tubular at bottom and stopcock at top.

Cat. No.	Size mm.	Price/Piece Rs.
1063/1	38 x 250	780-00
1063/2	50 x 300	950-00
1063/3	60 x 300	1390-00

1064 Tutwiler Gas Burette, "LABCO", for determination of hydrogen sulphide, with stopcock at top and Bottom and only two graduation marks at 100 ml. and 110 ml. Complete with cylindrical reservoir at top, graduation downward from 0 to 9 ml.

3950-00

1065 Bunte Gas Burette, "LABCO", with stopcock 100 x 0.2 ml.

3950-00

1066 Hampl Gas Burette, "LABCO", with two way stopcock at top and three way stopcock at bottom, 100 x 0.2 ml. with levelling tube, without stand.

3950-00

1066/2 - do - with stand

4500-00

1069 Nitrometer Lunge's, "LABCO", 50 ml. x 0.1 ml. graduated tube, with cup graduated 0 to 10 ml. with double oblique bore stopcock, complete with plain levelling bulb.

3600-00

1070 - do - with stand and clamps.

4700-00

1071 Nitrometer Schiff's "LABCO", 100 x 0.2 ml. graduated tube, stopcock and levelling bulb.

1450-00

1072 - do - with stand and clamps.

2600-00

1073 Gas Collecting Tubes, "LABCO", with two three way double oblique bore stopcocks one on each side.

Cat. No.	Capacity ml.	Price/Piece Rs.
1073/1	15	685-00
1073/2	30	695-00
1073/3	70	730-00
1073/4	100	750-00
1073/5	250	810-00
1073/6	500	1175-00

1074 Gas Collecting Tubes, "LABCO", with two three way double oblique bore, PTFE key stopcocks one on each side.

Cat. No	Capacity ml.	Price/Piece Rs.
1074/1	15	1775-00
1074/2	30	1830-00
1074/3	70	1830-00
1074/4	100	1840-00
1074/5	250	1875-00
1074/6	500	1990-00

1075 Gas Collecting Tubes, "LABCO", with two, two way stopcocks one on each side.

Cat. No.	Capacity ml.	Price/Piece Rs.
1075/1	125	480-00
1075/2	250	550-00
1075/3	500	700-00

1076 Gas Collecting Tubes, "LABCO", with two, two way PTFE key stopcocks, one on each side.

Cat. No.	Capacity ml.	Price/Piece Rs.
1076/1	125	975-00
1076/2	250	1050-00
1076/3	500	1150-00

1077 Gas Washing Bottles, "LABCO", Dreshle's type, interchangeable joints.

Cat. No.	Capacity ml.	Price/piece Rs.
1077/1	125	560-00
1077/2	250	700-00
1077/3	500	830-00

1078 Spare Head, for above gas wash bottles. 275-00

1079 Gas Washing Bottles, "LABCO", with sintered disc, interchangeable joints.

Cat. No.	Capacity ml.	Price/Piece Rs.
1079/1	125	730-00
1079/2	250	850-00
1079/3	500	975-00

1080 Spare head, for above gas bottles. 470-00

1081 Gas Jar, "LABCO", with ground glass flat flange.

Cat. No.	Height O.D. mm.	Price/Piece Rs.
1081/1	150	50
1081/2	200	50
1081/3	200	75
1081/4	300	75

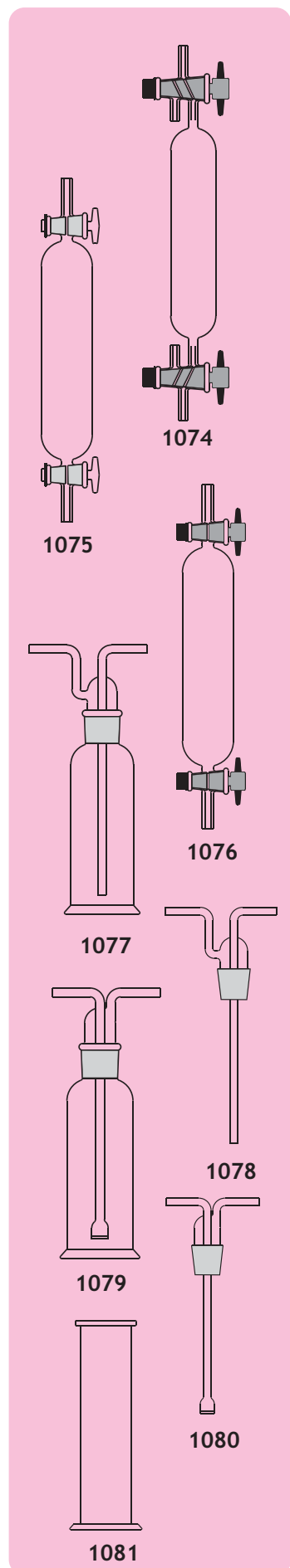

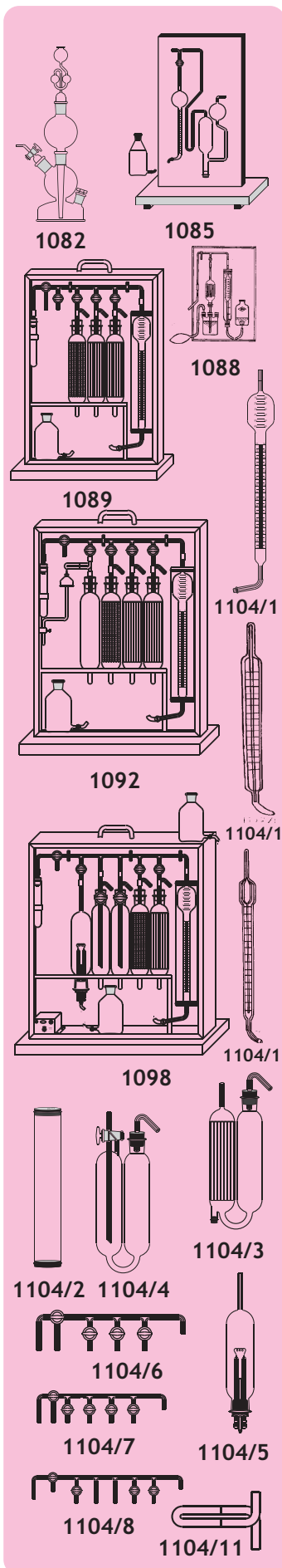

1082 Kipp's Apparatus, "LABCO", with interchangeable joints

Cat.No.	Capacity ml.	Price/piece Rs.
1082/1	100	1050-00
1082/2	250	2350-00
1082/3	500	3150-00
1082/4	1000	4300-00

1085 Assembly of Apparatus, "LABCO", for the determination of Oxygen, as per I.S. specification, fitted on wooden stand. 7400-00

1086 Complete Glass Parts, for App. No. 1085. 4400-00

1087 Gas Burette, Only for App. No.1085 1850-00

1088 Assembly of Apparatus, for the determination of Oxygen and other Active Contaminants as per I.S. specification complete on wooden frame. 14500-00

ORSAT GAS APPARATUS

1089 Orsat Gas Analysis Unit, "LABCO", with 3 three absorption pipettes of two compartment type, 100 ml Gas Burette with outer jacket, manifold with PTFE Stopcocks, and aspirator bottle, for the analysis of Co, O₂, Co₂ particularly in fuel and furnace gases, complete in wooden cabinet with sliding doors. 14950-00

1092 Orsat Gas Analysis Unit "LABCO", with four absorption pipettes of two compartment type, 100ml Gas Burette with outer Jacket, manifold with PTFE stopcocks and aspirator bottle, Palladium, asbestos tube, adjustable spirit lamp for the analysis of Co, O₂, Co₂, H₂ and Nitrogen (by difference) complete in wooden cabinet with sliding doors. 17800-00

1098 Orsat Gas Analysis Apparatus, "LABCO", with five absorption pipettes for determining CO₂, CO, H₂ illuminants methane, ethane and nitrogen (by difference). There are four absorption pipettes, of which two are compartment type filled with glass tubes to increase absorption area and two bubbling type with three way PTFE Stopcocks and one slow combustion pipette with platinum wire coil, and rheostat to operate on 220 volts, complete in wooden cabinet with sliding doors. 22300-00

1104 Spares of Orsat Gas Analysis Apparatus.

Cat.No.	Item	Price/Piece Rs.
1104/1	100 ml. burette only	600-00
1104/2	Water Jacket with Rubber Corks	400-00
1104/3	Absorption pipette filled with tubes	560-00
1104/3a	Absorption tube with copper wire	775-00
1104/4	Bubbler pipette with PTFE 3 way Stopcock	1375-00
1104/5	Slow combustion pipette	2500-00
1104/6	Manifold for Cat. No.1089	2900-00
1104/7	Manifold for Cat. No. 1092	3100-00
1104/8	Manifold for Cat. No. 1098	2900-00
1104/9	U Tube fitted with glass wool	375-00
1104/10	Levelling bottle 250 ml.	395-00
1104/11	Palladium Asbestos Tube	810-00

MANOMETER

- 1117 Manometer, "LABCO", U tube mounted on wooden stand with scale 500-0-500 mm. with out mercury. 2100-00
- 1117a -- do -- with scale 250-0-250 875-00
- 1118 - do - with scale 120-0-120 mm. 775-00
- 1119 Vacustat Gauge, "LABCO", Modified form of McLeod gauges, Range 10 mm to 0.01mm. Hg. Pressure. 6950-00

ELECTRODES APPARATUS

- 1121 Hoffman's Voltmeter, "LABCO", to demonstrate that H₂O consists of two volumes of Hydrogen and one volume of Oxygen with 50 ml. graduated limbs and removable platinum electrodes 1025-00
- 1122 - do - with 25 ml. graduated limbs. 940-00
- 1123 Spare Platinum Electrodes Pair for Hoffman's Voltmeter. 360-00
- 1124 Spare Carbon Electrodes Pair for Hoffman's Voltmeter. 200-00
- 1136 Transport Number, Determination Apparatus, "LABCO", Findly U form with silver electrodes. 1800-00
- 1138 Franz Diffusion Cell, "LABCO", To stuy diffusion of transdermal drug delivery system through membranes. Supplied without membrane cap. 50 ml. 8500-00
- 1138a ---- do ---- Cap. 100 ml. 8800-00
- 1139 Calomel Potential Vessel "LABCO", Ordinary 375-00
- 1140 Calomel Potential Vessel, "LABCO", with stopcock and side tube 495-00
- 1141 Calomel Electrode Vessel, "LABCO", Ordinary Plain with rubber connected side tube. 390-00
- 1142 Calomel Electrodes, "LABCO",

Cat.No.	Description	Price/piece Rs.
1142/1	With Platinum foil of 8 mm square	1250-00
1142/2	With Platinum foil of 4 mm square	1150-00
1142/3	With Silver foil of 8 mm square	590-00
1142/4	With Silver foil of 4 mm square	500-00
1142/5	With Platinum Wire of 10 mm length	675-00
1142/6	With Platinum Wire of 20 mm length	850-00
1142/7	With Silver Wire and Copper Wire connected	850-00

1143a Glass Electrode for pH meter B.N.C. Type

	Temp. Range	Resistance Mohms	Rates
Breakable	0-17° C	200-300	1050-00
Unbreakable	0-17° C	200-300	3025-00

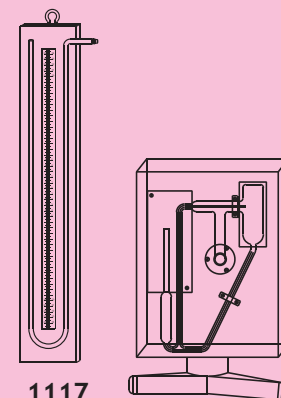

1117

1119

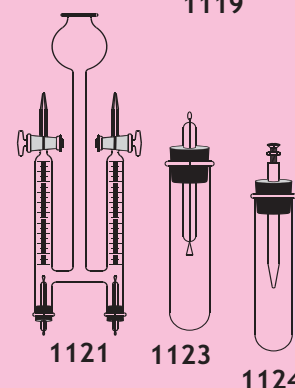

1121

1123

1124

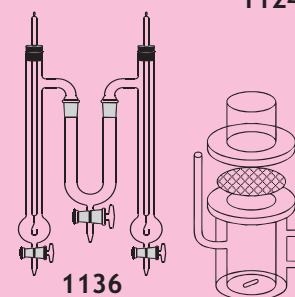

1136

1138

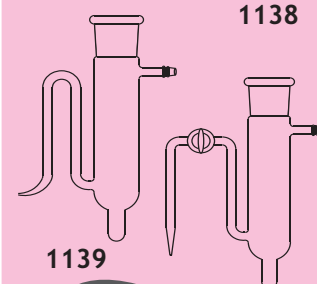

1139

1140

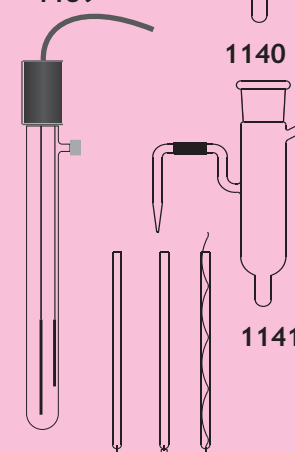

1141

1143a

1142

MOLECULAR WEIGHT APPARATUS

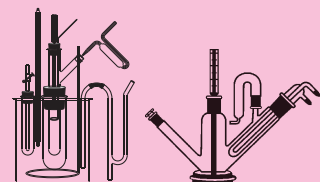

1157

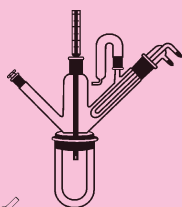

1158

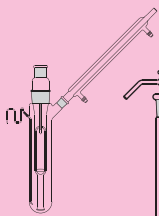

1159

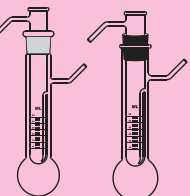

1160

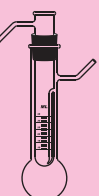

1161

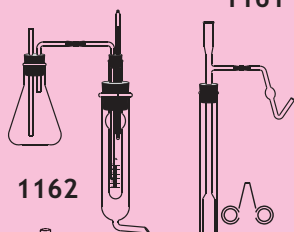

1162

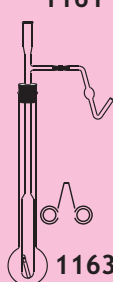

1163

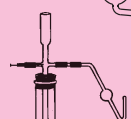

1165

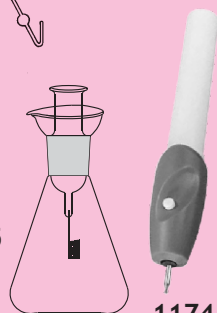

1174

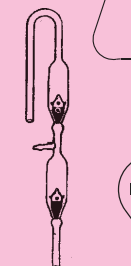

1179

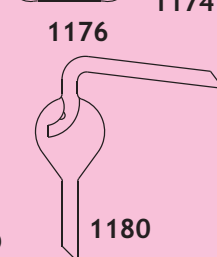

1176

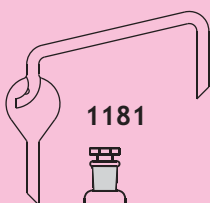

1181

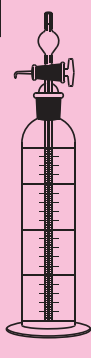

1184

1183

- 1157 Beckmann's Depression of freezing Point Apparatus, "LABCO", Comprising of outer jar with perspex cover & stirrer. Jacketed inner tube with nickel stirrer with Digital Pen type thermometer range from -50 to 300°C with resolution of $\pm 0.1^\circ\text{C}$ 4700-00
- 1158 Beckmann's Molecular Weight, "LABCO", for elevation of boiling point. Comprising of Air Jacket, Boiling Tube, Condenser, Drying Tube, Stopper etc. 6400-00
- 1159 Cottrel Brown, "LABCO", Boiling point apparatus. 2175-00
- 1160 Molecular Weight Determination Apparatus, "LABCO", McCoy's, ground glass fittings. 1175-00
- 1161 - do- with rubber cork fittings. 975-00
- 1162 Molecular Weight Determination Apparatus, "LABCO", (Land Berger's) Boiling Point method, modified by Walker and Lunsden 1075-00
- 1163 Vapour Density Apparatus, Victor Meyer's. 1175-00
- 1164 Spare Inner Tube, "LABCO", only for Victor Meyer's App. 345-00
- 1165 Victor Meyer's Apparatus, "LABCO", with glass jacket and Inner glass tube. 2900-00
- 1165/1 - do - same as above with copper jacket 4150-00

MISCELLANEOUS APPARATUS

- 1172 Silicon Vacuum Grease (Indian) 50gm pack 350-00
- 1173 Diamond point glass marking pencil Indian make. 575-00
- 1174 Engraving Pen. Battery operated, allows to write/etch and engrave either on glass, metal, plastic, wood, gadgets and other accessories, compact and light weight. Powered source : 2AA batteries 850-00
- 1175 Lab Grade Aluminium Foil Extra shining, Thickness 24 microns. Roll of 9 meters. 375-00
- 1176 Schoinger Micro Combustion Flask, "LABCO", (Oxygen Flask) with Platinum wire gauge sample carrier, for determination of Halogens, Sulphur Phosphorous metal etc. 27300-00
- 1180 Kjeldahl bulb, "LABCO", connecting, sloping, single.

Cat. No.	Bulb O.D mm.mm.	Tube O.D. Rs.	Price/Piece
1180/1	50	10	155-00
1180/2	65	10	175-00
1181	Kjeldahl bulb, "LABCO", connecting, Vertical		225-00
1182	- do - with two bulbs, "LABCO".		325-00
1183	Particle Size Determination Apparatus, "LABCO", (Sedimentation Pipette, Anderson) consisting of 500 ml. graduated cylinder, graduation from 0 to 20 cm. and fitted with 10 ml. pipette with three way stopcock, the tip of pipette at the level of 0 mark at the cylinder scale.		2100-00
1184	Dirt Correction Apparatus, "LABCO", 1000 ml with stopcock.		
1184/1	Plain		1780-00
1184/2	Graduated		2050-00

1189 Wash Bottles, "LABCO", with interchangeable joints.

Cat. No.	Capacity ml.	Price/piece Rs.
1189/1	250	475-00
1189/2	500	550-00
1189/3	1000	745-00

1190 Thiele's Melting Point Tubes, "LABCO".

Cat. No.	Size mm.	Price/Piece Rs.
1190/1	150 x 18	84-00
1190/2	150 x 25	102-00

1192 Melting Point Apparatus, "LABCO", (junge's) as per I.S. specification

1000-00

1193 - do - with standard joint fittings.

1250-00

1194 Viscometer, "LABCO", Ostwald, standard size, College Pattern, Centre support.

195-00

1194/1 - do - 80-100 Sec.

245-00

1194/2 - do - 100-120 Sec.

245-00

1195 Viscometer, "LABCO", Falling sphere, standard joint fitting.

Cat. No.	Bore of Tube mm.	Price/piece Rs.
1195/1	25	445-00
1195/2	40	530-00

(Note: For other type of viscometers, rates on request)

1196 Stalganometer, "LABCO", Straight, graduated

125-00

1196a -- do --- Same as above but with Rotaflow Teflon stopcock

255-00

1197 Stalganometer, "LABCO", Bent, graduated

135-00

1198 Stalganometer, "LABCO", Set of Three (One straight, two bent) in velvet lined box.

680-00

1199 Weight Thermometers "LABCO".

Cat. No.	Capacity ml.	Price/Piece Rs.
1199/1	5	58-00
1199/2	10	64-00
1199/3	25	88-00

1200 Pyknometers, "LABCO".

Cat. No.	Capacity ml.	Price/Piece Rs.
1200/1	5	94-00
1200/2	10	102-00
1200/3	25	130-00

1201 Dilatometer, "LABCO", Designed for measuring the expansion of edible oil and fats, over the temperature range during melting. The ratio of solid to liquid present can be obtained.

650-00

1202 Dilatometer, "LABCO", consist of 50 ml. flask with 30cm long graduated capillary of 1 mm bore with standard B 14 joint fitting

425-00

1203 Duma's Bulb, "LABCO",

440-00

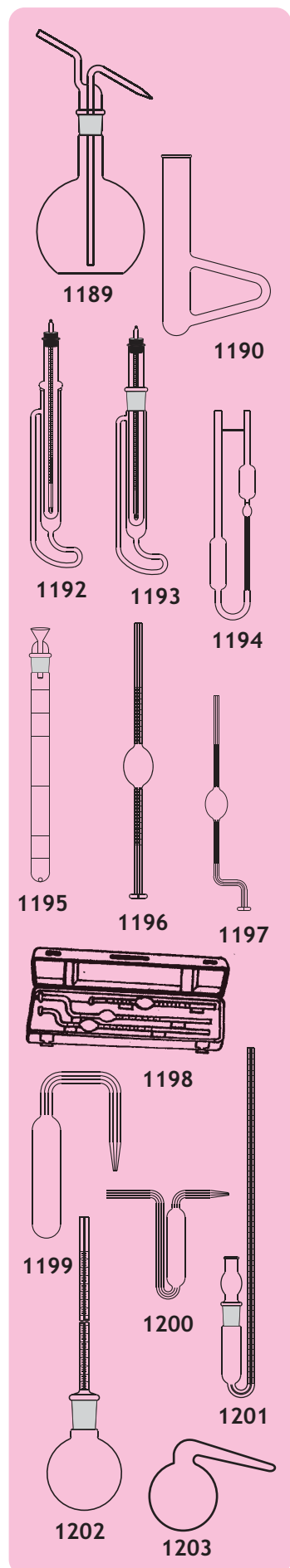

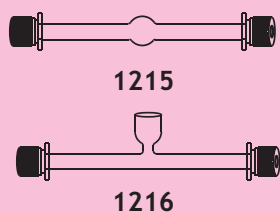
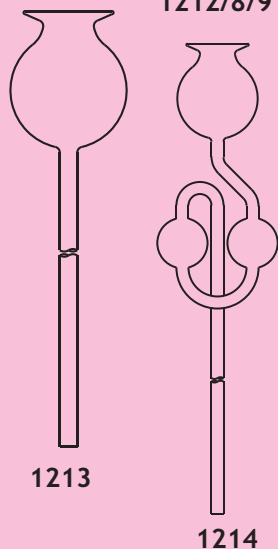
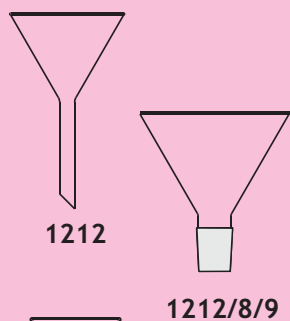
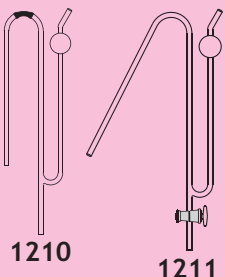
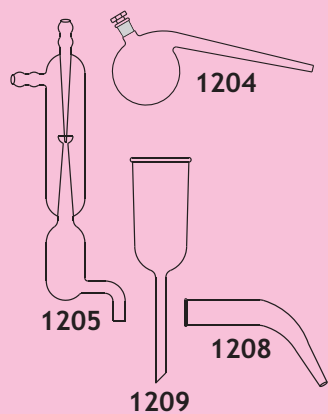

1204 Retorts, "LABCO", with interchangeable stopper.

Cat. No.	Capacity ml. Qty./Pack	Min. Rs.	Price/Piece
1204/1	100	2	330-00
1204/2	150	2	350-00
1204/3	250	2	390-00
1204/4	500	2	530-00
1204/5	1000	2	995-00

1205 Filter Pump, "LABCO", University pattern.

195-00

1206 - do - superior quality

240-00

1207 Filter Pump, "LABCO", Edward's type heavy pattern, Brass.

900-00

1208 Adapter, "LABCO", for Liebig's condenser straight or bent.

57-00

1209 Adapter, "LABCO", for Gooch Crucible.

Cat. No.	Capacity ml.	Price/piece Rs.
1209/1	15	84-00
1209/2	30	88-00
1209/3	50	118-00

1210 Syphon, "LABCO", with suction tube 18" long.

200-00

1211 - do - with suction tube and stopcock 18" long, "LABCO".

420-00

1212 Funnel Filtering, "LABCO", 60° angle with stem.

Cat. No.	Diameter mm. Qty./Pack	Min. Rs.	Price/piece
1212/1	25	10	42-00
1212/2	38	10	48-00
1212/3	50	10	54-00
1212/4	65	10	63-00
1212/5	75	10	78-00
1212/6	100	2	118-00
1212/7	125	2	240-00

Powder Funnel with B/24 cone

1212/8	100	240-00
1212/9	125	380-00
1212/10	150	695-00

1213 Thistle Funnel, "LABCO", 30 cm stem.

108-00

1214 - do - for Kipp's apparatus, "LABCO".

135-00

1215 Polarimeter Tubes, "LABCO", with Centre bulb, screw caps and cover glasses.

Cat. No.	Length mm.	Price/Piece Rs.
1215/1	100	1125-00
1215/2	200	1150-00
1215/3	400	1190-00

1216 Polarimeter Tubes, "LABCO", with Centre Cup, screw caps and cover glasses.

Cat. No.	Length mm.	Price/Piece Rs.
1216/1	100	1150-00
1216/2	200	1175-00
1216/3	400	1200-00

1217 Dewar flask, "LABCO", Double walled, cylindrical, evacuated, unsilvered.

Cat. No.	Inner Tube mm.ml.	Approx. cap. Rs.	Price/piece
1217/1	50 x 200	300	2000-00
1217/2	50 x 250	400	2200-00
1217/3	60 x 200	475	2450-00
1217/4	60 x 250	600	2500-00
1217/5	75 x 200	750	3300-00
1217/6	75 x 250	950	3650-00
1217/7	100 x 300	2000	6000.00

1218 Dewar flask, "LABCO", Double walled, cylindrical, evacuated, silvered.

Cat. No.	Inner Tube mm.ml.	Approx. cap. Rs.	Price/piece
1218/1	50 x 200	300	3750-00
1218/2	50 x 250	400	3950-00
1218/3	60 x 200	475	4200-00
1218/4	60 x 250	600	4400-00
1218/5	75 x 200	750	6500-00
1218/6	75 x 250	950	8200-00
1218/7	100 x 300	2000	14000-00

1219 Connection Tubes, "LABCO", T shape

Cat.No.	Tube dia mm.	Price/Piece Rs.
1219/1	7	54-00
1219/2	10	60-00
1219/3	12	74-00

1220 Connection Tubes, "LABCO", Y shape

Cat.No.	Tube dia mm.	Price/Piece Rs.
1220/1	7	54-00
1220/2	10	60-00
1220/3	12	74-00

1221 Connection Tubes, "LABCO", U shape

Cat.No.	Tube dia mm.	Price/Piece Rs.
1221/1	7	50-00
1221/2	10	55-00
1221/3	12	66-00

1222 Filter tubes, "LABCO", with side tube.

Cat. No.	Tube Size mm.	Price/Piece Rs.
1222/1	100 x 12	34-00
1222/2	125 x 15	39-00
1222/3	150 x 18	52-00
1222/4	150 x 25	63-00

1223 Chromatography Sprayers, "LABCO", with rubber bellow.

Cat. No.	Capacity ml.	Price/Piece Rs.
1223/1	100	485-00
1223/2	150	500-00
1223/3	250	525-00

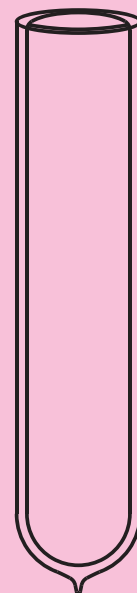

1217/18

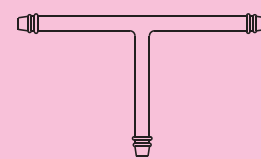

1219

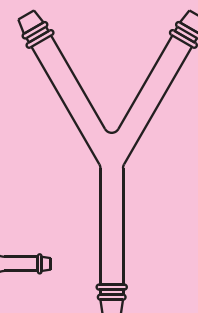

1220

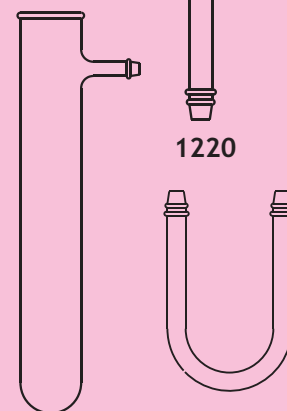

1221

1222

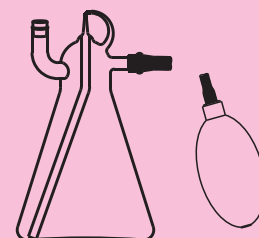

1223

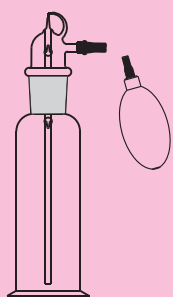

1224

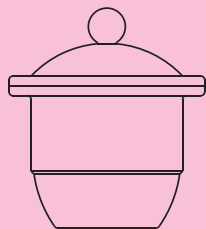

1225

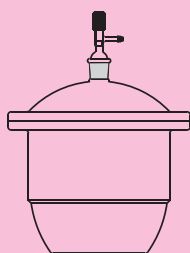

1226

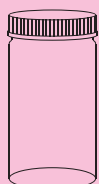

1227



1228



1230

1224 Chromatography Sprayers, "LABCO", Bottle type with interchangeable joints, rubber bellow.

Cat. No.	Capacity ml.	Price/Piece Rs.
1224/1	25	530-00
1224/2	50	560-00
1224/3	100	600-00

1225 Dessicator with Lid, Plain, Die pressed, Borosilicate Neutral Glass with porocelain perforated plate, "LABCO".

Cat. No.	I.D. mm	Price/Piece Rs.
1225/1	120	1325-00
1225/2	160	1825-00
1225/3	210	3100-00
1225/4	240	4700-00
1225/5	300	6800-00

1226 Dessicator with Lid, Vacuum, Die pressed, made of Borosilicate neutral Glass (with porocelain perforated plate and glass sleeve "LABCO")

Cat.No.	I.D. mm.	Price/Piece Rs.
1226/1	160	2200-00
1226/2	210	4350-00
1226/3	240	6800-00
1226/4	300	9400-00

1227 Specimen Jars, "LABCO", with bakelite screw cap, suitable for Culture, Autoclaveable

Cat. No.	SizeApprox. Cap. mm.ml.	Price/piece Rs.	
1227/1	50 x 75	100	235-00
1227/2	60 x 110	250	330-00
1227/3	75 x 130	500	475-00
1227/4	90 x 185	1000	710-00

1228 Weighing Scoops, "LABCO", with open tubular arm, nominal capacity 3 ml., 6 ml. or 10 ml. Suitable for use when small quantity of dyes or powders are to be weighed

200-00

1229 Spatula Ended Spoon, "LABCO", used for ointments and lotions, suitable for the quick dispensation of Phosphorous and Sodium.

60-00

1230 Kjeldahl Digestion Tubes, "LABCO", with constriction on top.

Cat. No.	Tube Size mm.	Price/Piece Rs.
1230/1	24 x 250	185-00
1230/2	26 x 250	190-00
1230/3	26 x 300	240-00
1230/4	40 x 300	285-00
1230/5	42 x 300	350-00

1230a Stand Alluminium to hold & carry Kjeldhal digestion tubes "LABCO", for 15 tubes

2400-00

ARSENIC APPARATUS

1236	Arsenic Apparatus, Gutzeit modified form according to I.S. specification with Indian glass bottle.	395-00
1237	Arsenic Apparatus, "LABCO", According to B.P. Specification	660-00
1238	Arsenic Apparatus, "LABCO", (Silver Diethyldithio carbonate method) according to I.S. specifications.	1190-00
1239	Arsenic Apparatus "LABCO", for the determination of Arsenic and Sb. in brasses, bronze, ferrous and non-ferrous alloys etc. by distillation, without stand, clamp and burner.	2775-00
1240	Arsenic Determination Apparatus, "LABCO", Gutzeit (modified) composing of 100 ml bottle with interchangeable fitting. The arsenic tube is in two parts with ground flange ends, together with 30 ml open top funnel attached in the bottle.	1840-00
1241	Arsenic Apparatus "LABCO", as per USP 211, organic & inorganic materials	1525-00
1242	Apparatus for Limit Test for Arsenic as per IP	1425-00
1243	Arsenic Limit Test Apparatus As per JP	1425-00

COLUMN STORAGE CABINET

1245 Column Storing Cabinet "LABCO", for storing columns upto 100-300 mm length. With locking arrangement & moving wheels. Complete Cabinet made of Stainless Steel grade SS316.

Column Length(mm)	No. of Columns	Each Drawer Cap. Column	No. of Drawers	Price/Piece Rs.
a. 100-300	315	15	22	99900-00
b. 100-300	150	15	11	79000-00

Note :- One last drawer in each above Cabinet will have four equal cushioned Compartments for keeping end fittings, Cartridges, couplings & other spares etc.

CARBON, SULPHUR DETERMINATION APPARATUS GLASS PARTS

1250	Absorption Vessel, "LABCO", with 3 valves, for KOH	2975-00															
1251	Carbon Burettes Double Walled, "LABCO", Inner tube permanently graduated, with one valve at the top.																
<table border="1"> <thead> <tr> <th>Cat. No.</th> <th>Size %</th> <th>Price/piece Rs.</th> </tr> </thead> <tbody> <tr> <td>1251/1</td> <td>0.25</td> <td>2950-00</td> </tr> <tr> <td>1251/2</td> <td>0.50</td> <td>2950-00</td> </tr> <tr> <td>1251/3</td> <td>1.50</td> <td>2950-00</td> </tr> <tr> <td>1251/4</td> <td>4.50</td> <td>3075-00</td> </tr> </tbody> </table>		Cat. No.	Size %	Price/piece Rs.	1251/1	0.25	2950-00	1251/2	0.50	2950-00	1251/3	1.50	2950-00	1251/4	4.50	3075-00	
Cat. No.	Size %	Price/piece Rs.															
1251/1	0.25	2950-00															
1251/2	0.50	2950-00															
1251/3	1.50	2950-00															
1251/4	4.50	3075-00															
1252	Thermometer Enclosure Type, 50°C, Alcohol filled for above Carbon Burettes.	590-00															
1253	Thermometer Stem Type, 50°C, Alcohol filled for Carbon Burettes.	325-00															
1254	Sulphur Burette, "LABCO", 4 ml with automatic Zero, three way double oblique bore stopcock at the bottom.	860-00															

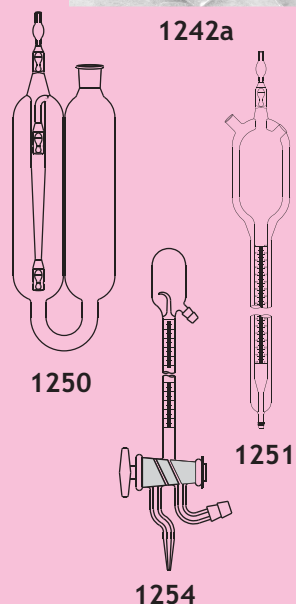
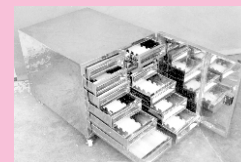
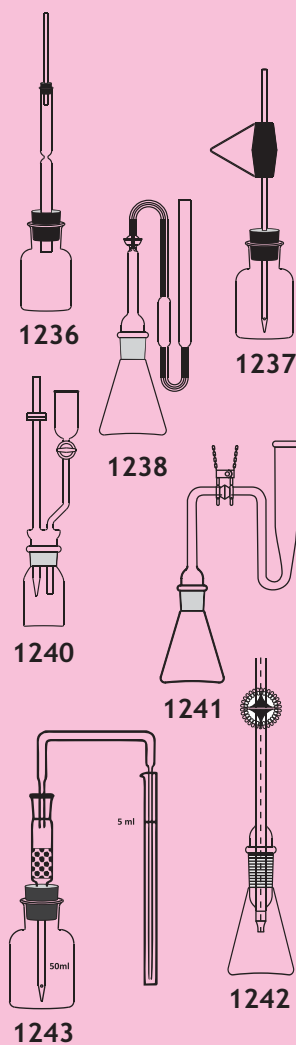

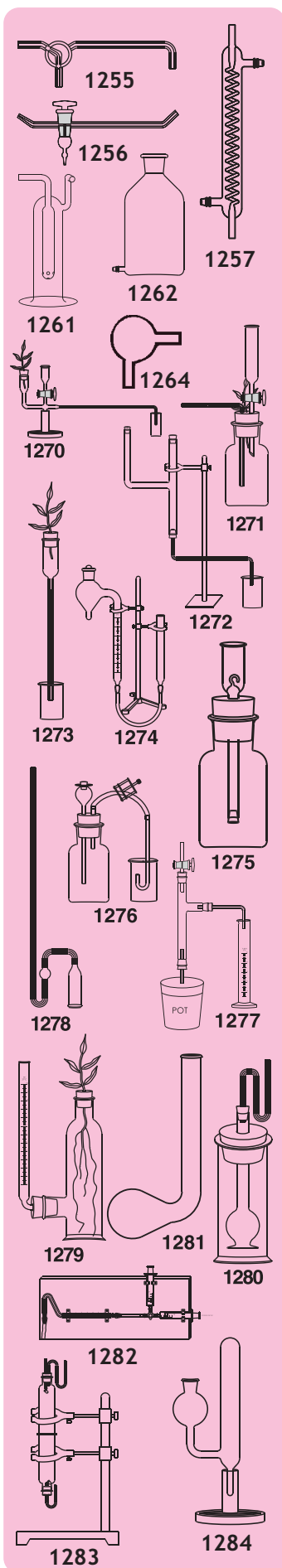

1255	Stopcock, "LABCO", three way, C bore, T shape.	725-00
1256	Stopcock, "LABCO", 'L' Shaped, Long Glass Tube, Twin Bore stopper.	725-00
1257	Spiral Cooling Condenser, "LABCO".	470-00
1258	Automatic Pipette, "LABCO", 15 ml.	475-00
1259	Automatic Pipette, "LABCO", 10 ml.	500-00
1260	Titration Vessel, "LABCO", 100 ml.	940-00
1261	Oxygen Purifying Assembly, "LABCO".	490-00
1262	Aspirator Bottle (Levelling Bottle) for carbon burette, 1000 ml. capacity.	750-00
1263	- do - long form	990-00
1264	View Bulb, "LABCO", for combustion tube.	58-00

PLANT PHYSIOLOGICAL APPARATUS

1270	Potometer, Ganog's Borosilicate glass	680-00
1271	Potometer, Farmer's Soda Glass bottle Borosilicate glass fitting.	1000-00
1272	Potometer for observing the rate of absorption of water by transpiring plants under varying circumstances, complete	1125-00
1273	Apparatus for demonstrate suction due to transpiration. A capillary tube with funnel at top and scale attached	325-00
1274	Respirometer, Complete with graduated and levelling tubes, Rubber tubing and stand.	1375-00
1275	Willmout Bubbler with Soda glass bottle.	675-00
1276	Demonstration Respiroscope, with soda glass bottle.	945-00
1277	Apparatus for experiments, on root pressure, T-tube with stopcock and Soda Glass, Graduated Jar, Without Pot.	770-00
1278	High Pressure Manometer, Ganong's.	375-00
1279	Apparatus for the determination the quality of water absorbed and Given off by transpion plants, Soda Glass bottle, Borsiicate Glass side tubes.	640-00
1280	Apparatus for the demonstration of osmotic pressure, Pfeffer's complete Soda Glass Jar	640-00
1281	Retort Shaped Vessel, for the culture of plants in a space devoid of Oxygen.	330-00
1282	Photosynthesis Apparatus, Comprises two syringes connected to a collecting tube via a 3-way tap. This arrangement enables the gas to be drawn along the capillary tube by on syringe and collected into the second syringe for analysis. The apparatus is mounted on a background 240x100mm Capillary bore 1mm.	1650-00
1283	Apparatus for investigating, transpiration complete on stand.	1540-00
1284	Fermentation Vessel, Kuhn's on stand.	415-00

DAIRY AND MILK TESTING APPARATUS

1291	Butyrometer ISI marked (Pack of 10 Pcs.	730-00
1292	Butyrometer Butter grade 0-70-90% with capacity 5 gm., flat scale, weighing type.	615-00
1292/1	Butyrometer Butter, milk powder, Grade 0 - 35% with cup & stopper, weighing type	615-00
1293	Butyrometer Cream 0-70% weighing type 5 gm flat scale as per ISI specifications.	615-00
1293/1	Butyrometer Ice cream, 0 - 20% volumetric method as per ISI specs	615-00
1293/2	Butyrometer cheese, 0 - 40% volumetric method as per ISI specs	615-00
1293/3	Butyrometer chocolate, 0 - 20% volumetric method as per ISI specs	615-00
1294	Butyrometer Skim milk 0-4% flat scale as per ISI specifications.	615-00
1294a	Lactometer, Sp. Gr. range 0-40	160-00
1294b	--- do --- same as above, range 15-40	160-00
1294c	Lactometer Jar Polypropylene	78-00
1295	Lock Stopper for Butyrometer (Pack of 12 pcs)	155-00
1295a	SS key for Butyrometer stopper	145-00
1296	Mojjonier flask as per ISI specifications.	510-00
1296a	Silicon cork for Majjonier flask	54-00
1296b	Majjonier flask Stand, "LABCO", Made of Imported transparent sheet. Holding Capacity 6 Nos.	4900-00Ea
1297	Rilchert Wollney's Apparatus, "LABCO", for the determination of volatile fatty acids in magarine and butter, with rubber cork fitting without stand and burner.	1000-00
1298	- do - with standard joint fitting.	1290-00
1299	Polenske's Apparatus, (R.M. value Apparatus), "LABCO", for the determination of butter fat and analysis of oil, fats, waxes with rubber cork fitting.	1000-00
1300	- do - with standard joint fitting.	1380-00
1301	Flask flat bottom 300 ml for Cat. No. 1297 & 1299	165-00
1302	- do - with B 24 socket for Cat No. 1298 & 1300	215-00
1303	Condenser for Polenske's Apparatus or Reichert Wollney's Apparatus, "LABCO".	345-00
1304	- do - with B 24 socket.	385-00
1305	Still Head for Cat. no. 1297 or 1299	170-00
1306	- do - with standard joints 1298 & 1300	290-00
1307	Flask standard 100-110 marked, "LABCO".	340-00

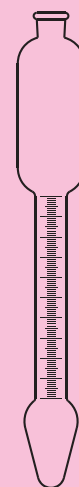

1291

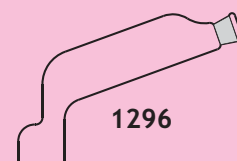

1296

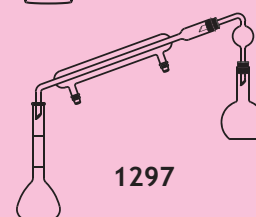

1297

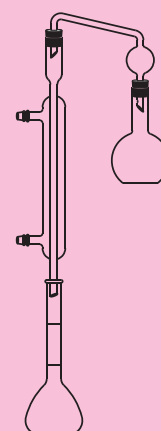

1299

THERMOMETERS

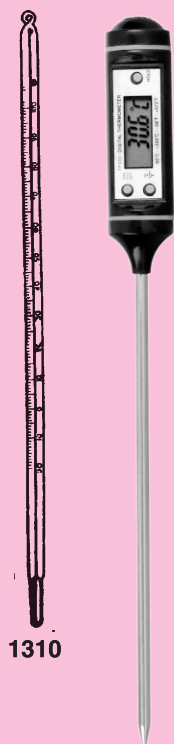

1310



1311



1311a

1312



1312
a & b

1313

1310 Chemical Thermometers, "LABCO", Alcohol/Mercury Filled 30 cm. long, accuracy ± 1 division.

Cat. No.	Range	Division	Superior quality (Indian)	Imported Capillary (Zeal Type)
1310/1	0-50°C	1/1	135-00	265-00
1310/2	0-50°C	1/2	135-00	265-00
1310/3	0-100°C	1/1	120-00	265-00
1310/4	-10-100°C	1/1	120-00	265-00
1310/5	-10-110°C	1/2	120-00	265-00
1310/6	0-150°C	1/1	120-00	265-00
1310/7	0-200°C	1/1	130-00	265-00
1310/8	0-250°C	1/1	130-00	265-00
1310/9	0-300°C	2/1	130-00	265-00
1310/10	0-360°C	2/1	130-00	265-00
1310/11	0-222°F	1/1	130-00	265-00
1310/12	0-80°R	1/1	140-00	265-00

1311 Digital Pen Type Thermometer, "LABCO", easy to use. Touch the object and press the ON button to measure the temp. Range : -50 to 300°C (-58 to 570°F) Resolution ± 0.1 °C/°F

985-00

1311a LCD Portable Digital Multi Thermometer, "LABCO", with external sensing probe. Temp. Range -50°C to 300°C (58°F to 572°F) Resolution ± 0.1 °C/°F Accuracy ± 1 °C upto in the range -50 to 200°C

1550-00

1312 Precision Chemical Thermometers, "LABCO", Accuracy ± 1 division.

Cat. No.	Range	Division	Superior Quality	
1312/1	-10-50°C		1/5	170-00
1312/2	-10-50°C		1/10	255-00
1312/3	-10-110°C		1/5	280-00
1312/4	-10-110°C		1/10	310-00

1312a Precision Digital Thermometers, "LABCO", 3½ LCD portable digital thermometer. Temp. range -50 to +200°C, resolution 0.1°C, accuracy ± 1 digit, Sensor input - PT 100

8900-00

1312b Precision Digital Thermometers, "LABCO", 3½ LCD portable digital thermometer. Temp. range 40 to +1000°C, resolution 1°C, accuracy $\pm 1\%$ Sensor input - K type thermocouple

12500-00

1313 Thermometers, "LABCO", with cone, enclosed type. Accuracy \pm division.

Cat. No.	Range	Cone	Price/Piece Rs.	
1313/1	-10-50°C		B 10	325-00
1313/2	-10-110°C		B 14	465-00
1313/3	0-250°C		B 14	465-00
1313/4	0-360°C		B 14	470-00
1313/5	-10-110°C		B 19	545-00
1313/6	0-250°C		B 19	545-00
1313/7	0-360°C		B 19	550-00

1314 Immersion Thermometers, "LABCO", Mercury in glass, engraved on stem, Accuracy ± 1 division.

Cat. No.	Range	Immersion length cms	Total length cms	Price/Piece Rs.
1314/1	110°C	15	45	255-00
1314/2	250°C	15	45	255-00
1314/3	360°C	15	45	255-00
1314/4	110°C	30	60	325-00
1314/5	250°C	30	60	325-00
1314/6	360°C	30	60	325-00

1315 Low Temperature Thermometers, "LABCO", (Alcohol filled) 30 cms. long. Accuracy ± 1 division.

Cat. No.	Range	Division	Price/Piece Rs.
1315/1	-30 to +50°C	1°C	215-00
1315/2	-50 to +50°C	1°C	235-00
1315/3	-50 to +100°C	1°C	235-00
1315/4	-100 to + 50°C	1°C	300-00

1316 Oven/Incubator Thermometers, "LABCO", L shaped size 200 mm. X 200 mm., mercury in glass. Accuracy ± 1 division.

Cat. no.	Range	Division	Price/Piece
1316/1	110°C	1°C	275-00
1316/2	250°C	2°C	275-00
1316/3	360°C	2°C	275-00

1318 Maximum and Minium Thermometer, "LABCO". 240-00

1319 Maximum and Minium Thermometer, "LABCO", superior Quality Indian 675-00

1319a Maximum and Minium Thermometer, Imported U.K. make 950-00

1320 Wet and Dry thermometer, "LABCO", 240-00

1321 Wet and Dry thermometer, "LABCO", Superior Quality Indian 675-00

1321a Wet and Dry thermometer, Imported U.K. make 950-00

1322 Wall Thermometer, "LABCO", in PVC Groove type, base plate 20 cms 80-00

1323 Wall Thermometer, "LABCO", in PVC Groove type, base plate 40 cms 270-00

1324 Wall Thermometer, "LABCO", wooden base half meter long 520-00

1325 Wall Thermometer, "LABCO", One meter long 845-00

1326 Human Thermometer, Analogue type 140-00

1326a Human Thermometer, Digital 675-00

1327 Digital Humidity and Temperature Clock, "LABCO", Temp. Range : Indoor : -10°C to 50°C (+14°F to +122°F), Humidity Range : Indoor : 20% to 99% RH. Memory of MAX / MIN values of Temp. & Humidity 1250-00

1328 Infra Red Thermometer, "LABCO", Laser targeting, one hand operation, LCD with back light. Range -50 to 550°C 2950-00

1329 Soil Thermometer, with brass cone at bottom, Range 100°C or 180°F, 100 mm long brass cone. 580-00

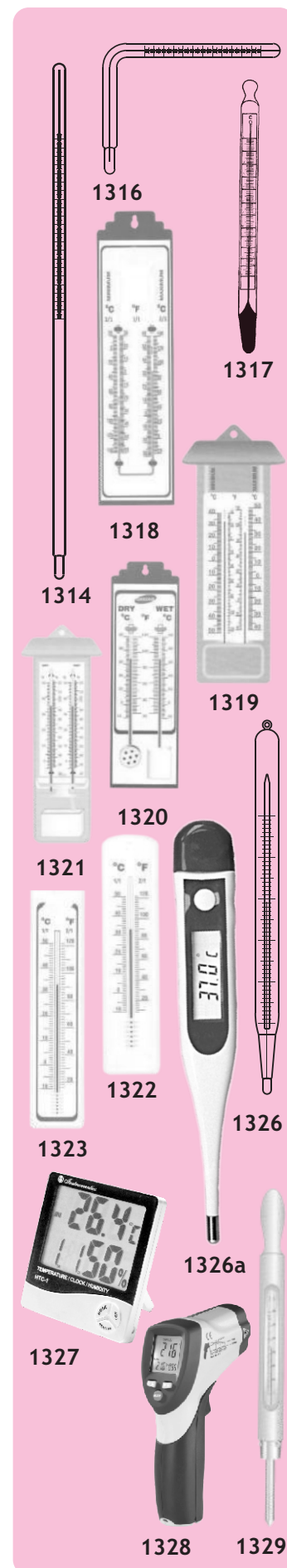

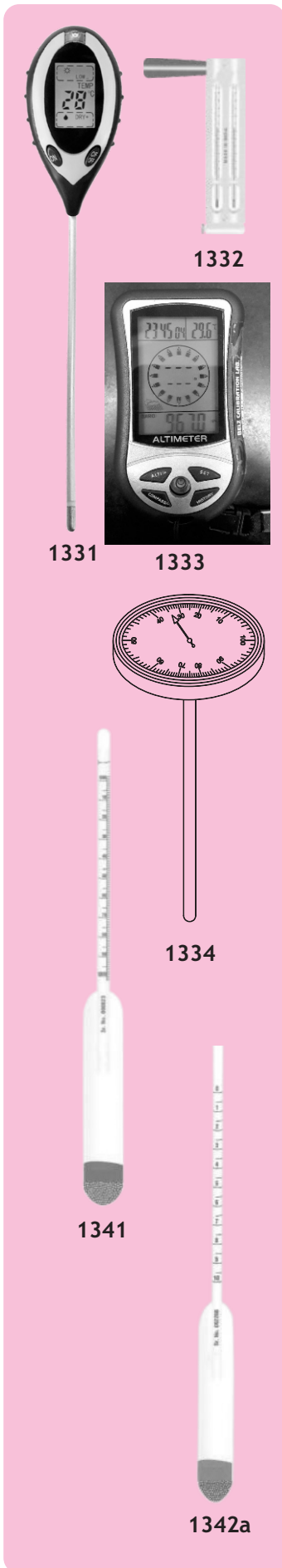

- 1331 Soil Survey Instrument (4 in 1), "LABCO",** It can test moisture of soil, pH value, Temp. & Environment sunlight intensity using a probe with length of 200mm. The unit can easily display various readings with oversize LCD. Unit also has low battery indication and auto power off function. It is saving time, energy of high efficiency. This unit assures quality of flowers and grasses plnting and garden virecence. 6500-00
- 1332 Psychrometer, (Whirling Hygrometer)** in plastic frame, with chart. 690-00
- 1333 Barometer/Altimeter/Timer, Digital, Barometer Range :- 200-1050mbar/hPa, Altimeter Range :- 703-4191 meter, Temp. Range :- 10-60°C. Resolution :- 1 meter/0.1mbar/0.1°C** 9500-00
- 1334 Bi-Metal Dial thermometer, Stem length 30 cm., stem at back, made of brass.**

Cat. No.	RangeDial dia mm.	Price/Piece Rs.	
1334/1	0-100°C	65	990-00
1334/2	0-150°C	65	1000-00
1334/3	0-200°C	65	1000-00
1334/4	0-250°C	65	1000-00
1334/5	0-300°C	65	1000-00
1334/6	0-350°C	65	1000-00
1334/7	0-100°C	100	1175-00
1334/8	0-150°C	100	1175-00
1334/9	0-200°C	100	1175-00
1334/10	0-250°C	100	1200-00
1334/11	0-300°C	100	1200-00
1334/12	0-350°C	100	1200-00

HYDROMETERS

- 1341 Specific gravity Hydrometers, in 100 degree range, shot weighted with paper scale.**

Cat. No.	Range	Price/Piece Rs.
1341/1	600-700	235-00
1341/2	700-800	235-00
1341/3	800-900	235-00
1341/4	900-1000	235-00
1341/5	1000-1100	235-00
1341/6	1100-1200	235-00
1341/7	1200-1300	250-00
1341/8	1300-1400	250-00
1341/9	1400-1500	265-00
1341/10	1500-1600	265-00
1341/11	1600-1700	265-00
1341/12	1700-1800	280-00
1341/13	1800-1900	540-00
1341/14	1900-2000	540-00

- 1342 Universal Hydrometer Range 700-2000 Sp.Gr.** 175-00

- 1342a Density Hydrometers for Analytical laboratories ISI marked. Shot & Wax Poised, Adjusted for use at 15°C M-50 SP.**

Cat. No.	Sp. Gr. Range	For	Length (mm)	Price/Piece Rs.
1342a/1	0.650-0.700	ATF(Sea)	270	365-00
1342a/2	0.700-0.750	Petrol	270	365-00
1342a/3	0.750-0.800	Kerosene	270	365-00
1342a/4	0.800-0.850	Diesel	270	365-00
1342a/5	0.850-0.900	Mobile Oil	270	365-00
1342a/6	0.900-0.950	Oils	270	365-00
1342a/7	0.950-0.1000	Petroleum Ether	270	365-00

1343 Beame Hydrometer, Shot weighted with paper scale.

Cat. No.	Range	Price/Piece Rs.
1343/1	Light Liquid range 10-70 Be, 0.700-1.000 Sp.Gr.	102-00
1343/2	Heavy liquid range 0-70 Be, 1.000-2.000 Sp.Gr.	102-00
1343/3	Beame Hydrometer range 0-50 Be, 1.000-1.500 Sp. Gr.	115-00
1343/4	Beame Hydrometer range 50-70 Be, 1.500-2.000 Sp. Gr.	115-00

1344 Beame Hydrometer , In 20 degree range, shot weighed with paper scale.

Cat.No.	Range	Price/piece Rs.
1344/1	0-10 Be	235-00
1344/2	10-20 Be	235-00
1344/3	20-30 Be	235-00
1344/4	30-40 Be	235-00
1344/5	40-50 Be	235-00
1344/6	50-60 Be	265-00
1344/7	60-70 Be	265-00

1345 Beame Hydrometer, in 20 degree range shot weighed with paper scale.

Cat No.	Range	Price/Piece Rs.
1345/1	0-20 Be	265-00
1345/2	20-40 Be	265-00
1345/3	40-60 Be	265-00

1346 Brix Hydrometer, Shot Weighed with paper scale, without thermometer.

Cat.No.	Range	Price/Piece Rs.
1346/1	0-10 Bx, 10-20 Bx, 20-30 Bx 30-40 Bx, 40-50 Bx, 50-60 Bx 60-70 Bx, 70-80 Bx, 80-90 Bx	410-00
1346/2	0-20 Bx, 20-40 Bx, 40-60 Bx, 60-80 Bx	410-00
1346/3	0-30 Bx, 30-60 Bx, 60-90 Bx	410-00

1347 Brix Hydrometer, Shot weighed with paper scale with built in thermometer.

Cat. No.	Range	Price/Piece Rs.
1347/1	0-10 Bx, 10-20 Bx, 20-30 Bx 30-40 Bx,40-50 Bx, 50-60 Bx	865-00

1348 Sike's Hydrometer, Shot weighed with paper scale.

Cat.No.	Range	Price/Piece Rs.
1348/1	0-20,20-40, 40-60, 60-80, 80-100	415-00

1349 Twaddle Hydrometers.

Cat.No.	SizeRange	Price/Piece Rs.	
1349/1	1	0-24	255-00
1349/2	2	24-48	255-00
1349/3	3	48-72	255-00
1349/4	4	72-102	255-00
1349/5	5	102-138	270-00
1349/6	6	138-170	270-00

1350 Battery Hydrometers, Complete with specific gravity hydrometer range 1.1 to 1.3, glass jar, rubber stopper and rubber bulb. Superior quality.

625-00

1350a ---- do ---- Routine quality

375-00



SEMI MICRO ANALYSIS APPARATUS

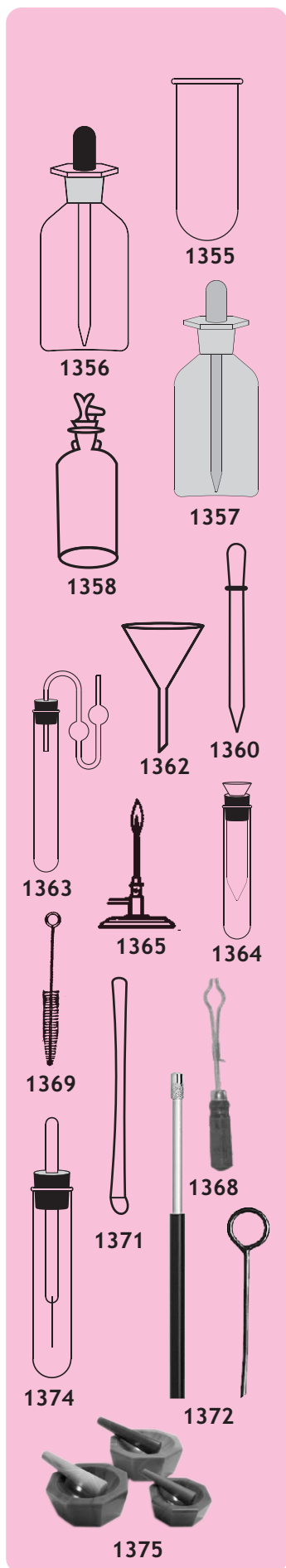

1355. Boiling tubes with rim.

Cat. No.	Size mm.	Price/Piece Rs.
1355/1	75 x 10	6-75
1355/2	75 x 12	6-90
1355/3	100 x 12	8-75
1355/4	60 x 15	17-75
1355/5	60 x 25	24-50

1356 Dropping Bottle, Indian glass with dust proof head, glass dropper and rubber teat.

Cat. No.	Capacity ml. Qty./Pack	Min. Rs.	Price/Piece
1356/1	30	12	86-00
1356/2	60	12	110-00
1356/3	120	12	128-00

1357 Dropping Bottle, Indian glass amber colour with dust proof head, glass dropper and rubber teat.

Cat. No.	Capacity ml. Qty./Pack	Min. Rs.	Price/Piece
1357/1	30	12	148-00
1357/2	60	12	160-00
1357/3	120	12	210-00

1358 Dropping Bottle, T.K.Pattern Indian glass with grooved stopper.

Cat. No.	Capacity ml. Qty./Pack	Min. Rs.	Price/Piece
1358/1	30	12	94-00
1358/2	60	12	108-00
1358/3	120	12	142-00

1360 Dropper, with rubber teat.

Size	4"	6"	8"	
	24-00	25-00	33-00	each

1362 Micro Funnel, 20 mm dia.

44-00

1363 Gas Absorption Pipette, with rubber cork fitted in 75 x 10 mm. test tube.

58-00

1364 Filter Tube, Test Tube 75 x 10 mm with 55 x 7 mm filter tube.

38-00

1368 Semi Micro, Test Tube holder with wooden handles & brass strip. Superior quality (Pack of 12 Pcs)

355-00Pk.

1368a --do-- Same as above with wooden handles. Routine quality (Pack of 12 Pcs)

335-00Pk.

1368b Test tube holder for holding large dia (upto 25mm) Test tube. Superior quality pack of 12 pcs.

390-00Pk.

1369 Semi Micro, Test Tube brush. (Pack.50Pcs.)

790-00Pk.

1369a Test tube brush for large test tubes (upto 25mm dia) Pack of 50 pcs.

900-00Pk.

1370 Semi Micro, Test Tube Stand. (Pack of 12 Pcs.)

1450-00Pk.

1371 Semi Micro, Stainless steel spatula (Pack of 12 Pcs.)

455-00Pk.

1372 Inoculation Loop with holder

250-00Each

1374 Platinum Wire, 35 x 0.2 mm Fused in glass rod and fitted in test tube.

385-00

1375 Agate Motor & Pestle, Black

Cat. No.	Size mm	Minimum Rs.	Price/Piece
1375/1	50	2	800-00
1375/2	75	1	1300-00
1375/3	100	1	2390-00
1375/4	125	1	3650-00
1375/5	150	1	6950-00

- 1376 Wire gauze heavy type superior quality (Pack of 12 pcs) 410-00 Pack
 1377 Filter Paper Circles, Superior quality (Pack of 100 Circles) 160-00 Pack
 1377a ----- do ----- Routine Quality 110-00 Pack
 1378 Filter Paper Sheets Good quality (Pack of 500 Sheets) Sheet Size 18"x22" 2450-00 Pack

- 1379 Water bath Made of Copper, Round type 6" dia with accentric rings, heavy quality 650-00 Ea

- 1381 Watch glass (Pack of 12 pieces)
 Size 50 mm 75 mm 100 mm 150mm
 Rate 200-00pak 285-00pak 380-00pak 860-00pak

- 1382 Nickle Crucible, with lid

Cat. No.	Capacity ml	Price/Piece Rs.
1382/1	25	625-00
1382/2	50	750-00

- 1385 Glass Rod, Hard glass assorted 6 mm-8mm (pack of 5 Kgs.) 1100-00 Per Pack

- 1385a Glass Tube, Hard Glass assorted 6mm - 10mm (pack of 5 kgs) 1100-00 Per Pack

- 1385b Fusion Tubes (Ord. Glass) (1 Gross Pack) 90-00 Per Pack

- 1386 Kipp's Apparatus, 100 ml. 1050-00 Ea

- 1387 Spirit Lamp Make 'LABCO' capacity 100-125ml Glass 170-00 Ea.

- 1387a -do- same as above, Made of Brass 195-00 Ea.

- 1387b -do- same as above, Made of alluminium 120-00 Ea.

- 1388 Gas Delivery tubes Dia 6mm (A, B & C) set of 3 325-00 set

- 1389 Magnifying Glass, Brass Frame with chrome plated handle. With 2.25X Zoom

Cat. No.	Lens Dia In Inches	Price/Piece Rs.
1389/1	2	75-00
1389/2	3	150-00
1389/3	4	225-00

- 1390 Magnifying Glass, Brass Frame with chrome plated handle. Lens Dia 6", with 1.83X Zoom 840-00

- 1391 Multi functional 3 in 1 hand held folding lighted high powered Magnifier glass with 3X Zoom and 2 LED Lights. Lens Dia. 65mm The 3 in 1 magnifier with 3X Zoom can be folded and can be transformed into a hands free stand. It works on 2AA batteries. 1050-00

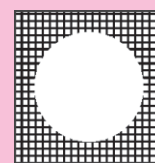

1376



1379

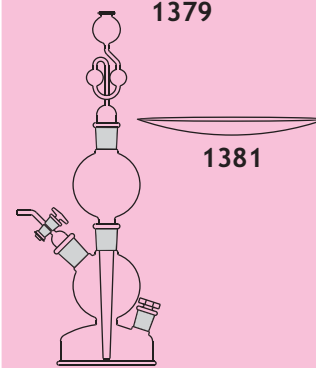

1381



1387

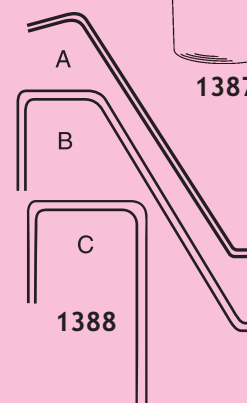

1388



1389



1391

SILICA LABORATORY WARE

1418 Silica Crucibles, "LABCO", with lid, withstands 800°C.

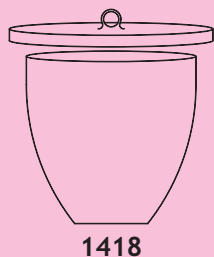

1418

Cat. No.	Capacity	Price/Piece Rs.
1418/1	15	655-00
1418/2	25	715-00
1418/3	50	1325-00
1418/4	100	3175-00
1418/5	150	3340-00

1419 Silica Crucibles, "LABCO", without lid, withstands 800°C.

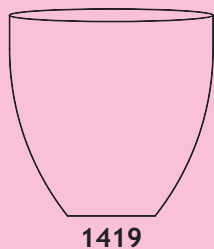

1419

Cat. No.	Capacity	Price/Piece Rs.
1419/1	15	340-00
1419/2	25	360-00
1419/3	50	650-00
1419/4	100	1460-00
1419/5	150	2000-00

1420 Silica Basins, "LABCO", with spout, Round Bottom, translucent, withstands 800°C.

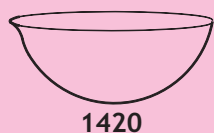

1420

Cat. No.	Capacity ml. mm	Dia x ht. Rs	Price/Piece
1420/1	20	35 x 40	575-00
1420/2	45	75 x 27	870-00
1420/3	70	87 x 33	1175-00
1420/4	100	80 x 85	2175-00
1420/5	200	98 x 103	2600-00

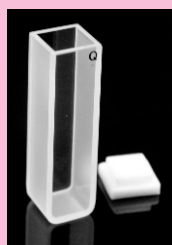

1421

1421 Quartz cell with PTFE cover, "LABCO", 10 mm path, 3.5 ml in pair

3150-00

1421/1 Glass cell with PTFE cover, "LABCO", 10 mm path, 3.5 ml in pair

1050-00

ANAEROBIC CULTURE JAR



1443

1443 Anaerobic Culture Jar, "LABCO", (Anaerobic system without Catalyst) Supplied with transparent unbreakable polycarbonate Jar of 3.5 Ltr. capacity having Sturdy ABS moulded Lid, clamp and sealing rubber "O" ring.

Supplied Complete with :

A) Stainless Steel Petri plate carrier for 10 Petri plates- 1Pc.

B) Stainless Steel test tube carrier

21000-00



1444

1444 Anaerobic Culture Jar, "LABCO", (With Vacuum cum Pressure gauge) Supplied with transparent unbreakable Polycarbonate jar of 3.5 liters capacity having Sturdy Aluminium Casted Lid and with built-in Pressure Valve, Safety Valve & 2 way Pressure cum vacuum Gauge, aluminium clamp and sealing "O" ring.

Supplied Complete with :

A) Stainless Steel Petri plate carrier for 10 Petri plates- 1Pc.

B) Stainless Steel test tube carrier

22000-00

MICROPIPETTE AUTOMATIC

1447 Micropipette, "LABCO", Fixed Volume

Cat. No.	Range (µl)	Price Ea	
		SemiAutoclavable	FullyAutoclavable
1447/1	1	1650-00	3100-00
1447/2	2	1650-00	3100-00
1447/3	5	1650-00	3100-00
1447/4	10	1650-00	3100-00
1447/5	20	1650-00	3100-00
1447/6	25	1650-00	3100-00
1447/7	50	1650-00	3100-00
1447/8	100	1650-00	3100-00
1447/9	200	1650-00	3100-00
1447/10	250	1650-00	3100-00
1447/11	500	1650-00	3100-00
1447/12	1000	1650-00	3100-00
1447/13	2000	1975-00	3100-00
1447/14	5000	1975-00	3100-00
1447/15	10000	1975-00	3100-00

1448 Micropipette, "LABCO", Variable Volume

Cat. No.	Range (µl)	Price Ea	
		SemiAutoclavable	FullyAutoclavable
1448/1	0.2 - 2.0	3000-00	5000-00
1448/2	0.5 - 10	3000-00	5000-00
1448/3	2 - 20	3000-00	5000-00
1448/4	5 - 50	3000-00	5000-00
1448/5	10 - 100	3000-00	5000-00
1448/6	20 - 200	3000-00	5000-00
1448/7	100 - 1000	3000-00	5000-00
1448/8	0.5 - 5ml.	3000-00	5000-00
1448/9	1 - 10ml.	3800-00	5800-00

1449 Micropipette, "LABCO", Multichannel with digital display tip ejector, two step operation, easy adjustment, of volume by turning the plunger.

Cat. No.	Range (µl)	Price Ea
1449/1	5 - 50	19700-00
1449/2	40 - 200	19700-00

1450 Tips for Micropipette, "LABCO".

Cat. No.	Range (µl)	Qty. /Pack	Price/Pack
1450/1	Yellow Tip upto 200	1000	570-00 Pk
1450/2	Blue Tip upto 1000	500	570-00 Pk

1451 Stand for Micropipette

1175-00 Ea

1452 Bottle Top Dispensers : All parts which comes in contact with reagents are made of PTFE, FEP and Borosilicate Glass, so can be used for all Laboratory Reagents dispensing needs. High accuracy and precision is ensured through several stages of strict quality checks during manufacturing. Each Dispenser is calibrated in accordance with ISO 8665 Standard, and supplied with certificate.

Product Information : Description

Piston
Cylinder
Value Housing
Value Assembly
Volume adjustment
Delivery Tube
Inlet Tube
Compatibility

Models

PTFE
Glass
Polypropylene
Glass
Screw Type
FEP
FEP

Excellent with all reagents except HF.





1452

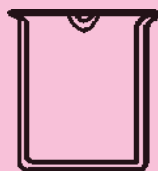

1490



1491

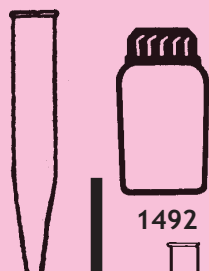

1493

1492

1494

1495

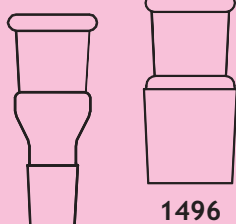

1497

1496



1499

Each dispenser is supplied with 1 standard adapter of 30 mm thread and 5 adapters of 28, 32,36, 40 & 45mm. To fit in most of the reagent bottles in Laboratories.

Note : Instrument is fully autoclavable.

Model	Vol. Range (ml)	Increment ml.	±%	Accu. ±ml.	Price/piece Rs.
LB-a	0.25 - 2.5	0.05	0.6	0.015	24500-00
LB-b	0.5 - 5	0.1	0.6	0.030	24500-00
LB-c	1 - 10	0.2	0.6	0.060	24500-00
LB-d	2.5 - 30	0.5	0.6	0.180	26800-00
LB-e	5 - 60	0.5	0.6	0.360	26800-00
LB-f	10 - 100	2.0	0.6	0.380	32500-00

"LABCO" LABORATORY TEFLON WARES

1490 PTFE (Teflon) Beaker Low form with pour out & reinforced rim. Thickwall.

Cap.	25ml.	50ml.	100ml.	250ml.	500ml.	1000ml.
Rate	650-00	1200-00	2200-00	4000-00	5400-00	8600-00

1491 PTFE (Hexagonal) Stoppers, "LABCO".

Size	B10	B14	B19	B24	B29	B34
Rate	210-00	375-00	515-00	715-00	860-00	1150-00

1492 PTFE bottles with screw cap, Thick wall 'Labco'

Cap.	25ml	50ml	100ml	250ml	500ml	1000ML
Rate	3800-00	3900-00	4900-00	6000-00	11500-00	20550-00

1493 PTFE (Teflon) Centrifuge tubes, "LABCO".

Cap.	15ml	25ml	50ml
Rate	1030-00	1300-00	1550-00

1494 PTFE Plain Stirring rod 250mm long, "LABCO".

Dia	8mm	10mm	12mm
Rate	325-00	375-00	500-00

1495 PTFE (Teflon) Test tubes without rim, "LABCO".

Size	10x75mm	12x75mm
Rate	1450-00	1650-00

1496 PTFE (Teflon)Reduction Adaptors, "LABCO", Socket/Cone

B14/B19	B19/B24	B24/B34	B34/B55
940-00	1180-00	1400-00	3800-00

1497 PTFE (Teflon) Expansion Adaptors, "LABCO", Cone /Socket

B19/B14	B24/B19	B34/B24	B55/B34
940-00	1180-00	1400-00	4800-00

1498 PTFE (Teflon) Double Spatulas, "LABCO".

Length	120mm	150mm
Rate	1750-00	1950-00

1499 Magnetic Beads Teflon coated. (Moulded) Remi.

Size in	15 mm	20-25 mm	35 mm	50 mm
Length	148-00	200-00	260-00	375-00

CHROMATOGRAPHY APPARATUS (T.L.C.)

- 1512 Thin Layer Chromatography Kit, "LABCO",** Comprising of moveable applicator (Spreader) with built in arrangement, 0-2mm, perspex base plate 114 x 23 cm, Aluminium carrier, perspex spotting temp plate, developing chamber with lid, five T.L.C. plate 20 x 20 cm, two T.L.C. plate 20x5cm, scribe for marking lines, micropipette and glass sprayer with rubber bellow.

Cat. No.	Description	Price/Piece Rs.
1512/1	With Crome Plateed Brass Applicator	14000-00
1512/2	with Aluminium Applicator	11900-00

SPARE & ACCESSORIES 'LABCO'

1512/3	Applicator Brass	6500-00
1512/4	Applicator Aluminium	3500-00
1512/5	Spotting Temp. Plate perspex	640-00
1512/6	Aluminium carrier for ten plates of 20 x 20cm	1475-00
1512/7	Plate rack of S.S. for two plates, 20 x 20cm	640-00
1512/8	T.L.C. glass plates 20 x 20cm	80-00
1512/9	-do- 20 x 10 cm	50-00
1512/10	-do- 20 x 5 cm	42-00
1512/11	Chromatography Tank (Developing Chamber, 250 x 250 x 150mm) with cover for T.L.C. Plate of size 20x20cm	3100-00 Ea
1512/12	----- do -----Size 225 x 225 x 125mm	2400-00 Ea
1512/13	----- do -----Size 220 x 140 x 140mm	1600-00 Ea
1512/14	Perpex base size approx. 114 x 23 cm	2050-00
1512/15	Desicator cabinet 30 x 50 x 35cm	10300-00

- 1513 Paper Chromatography Cabinet, "LABCO",** Ascending or Descending, model of teak wood and glass construction. It can accommodate two (Troughs) and six glass rods.

Cat. No.	Description	Price/Piece Rs.
1513/1	Cabinet Size 60 x 30 x 60 cm Approx. for 4 filter papers of 46 x 57 cm Size	19400-00
1513/2	Cabinet Size 80 x 37.5 x 65 cm Approx. for 6 filter papers of 75 x 75 cm Size	21200-00
1513/3	Glass Boat for Cabinet 1513/1	1325-00
1513/4	Glass Boat for Cabinet 1513/2	1525-00

- 1514 Ultra Violet Chromatography Inspection cabinet, "LABCO",** For viewing and detecting separated substances on T.L.C. layers, fitted with long wave (365nm) U.V. lamp for use on 220volts A.C. 8600-00

- 1514/1 Ultra Violet Chromatography Inspection Cabinet, "LABCO",** For viewing and detecting separated substances of T.L.C. layers, fitted with one long wave (365 nm), U.V. tubes for use on 220 volts A.C. 9500-00

- 1514/2 Ultra Violet Chromatography Inspection Cabinet, "LABCO",** Dual Wave, having Filter fitted with separate low pressure mercury vapors tubes for short ultra violet (254 nm) and long UV (365 nm) plus separate lamp for visible light. The low pressure mercury vapour tubes facilitate immediate use. 16200-00

- 1514/3 Spare Ultra Violet Tube, 254 nm** 900-00

- 1514/4 Spare Ultra Violet Tube, 365 nm** 925-00

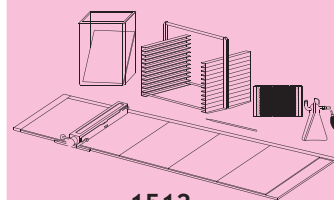

1512



1512/1



1513



1514

ROTARY VACCUM EVAPORATOR



1515



1516

1515 Rotary Vacuum flash Evaporator (Buchhi Type), "LABCO", comprising of AC non-sparking geared drive unit, support stand fitted with jack arrangement on S.S. rod, continuously variable speed regulator, **with Microprocessor based PID Digital Temperature Indicator cum controlled** water bath, double coil glass condenser, pear shaped evaporating flask cap. 800 ml, 1000ml. Receiving Flask with ball joints, feeding tube, rubber tube & vapour path tube, with Teflon & rubber seals for maintaining complete vacuum. 69000-00

1516do.... Same as above, but with LCD Display Micro Controller Based Digital Temperature Indicator Cum Controller 74000-00

Spare Parts of Rotary Flash Evaporator, Buchhi Type, "LABCO",

1516/1	Condenser double coil with S-35 ball joint & feed tube	7400-00
1516/2	Receiving flask, Cap. 1000 ml with S-35 cup joint	1075-00
1516/3	Boiling flask 800 ml with 24/29 socket. For other capacities Refer Cat. No. 694A	925-00
1516/4	Feed tube for condenser, with cone & Teflon tube	1100-00
1516/5	Vapour Path tube	875-00
1516/6	Silicon Washer for Condenser	225-00
1516/7	Oil seal rubber	160-00
1516/8	Tension spring for holding condenser	110-00
1516/9	Vacuum Pump for Rotary Flask Evaporator Oil Free	25300-00

KJELDHAL DIGESTION UNIT



1517

1517 Kjeldhal Digestion Unit, "LABCO", Complete with heating box and fume duct. The 500 watts heaters are 6 inches apart having individual On/OFF switches and energy regulators. The height of the side clamps provided, is adjustable to accommodate Kjeldhal Flasks of 300ml. 500ml or 800ml. Without glass parts but with fume duct.

1517/1S	Unit with individual energy Regulators for 3 Tests with 3 x 500ml flasks	13700-00
1517/2	Unit with individual energy Regulators for 3 Tests without flasks	10500-00
1517/3S	Unit with individual energy Regulators for 6 Tests with 6 x 500ml flasks	21000-00
1517/4	Unit with individual energy Regulators for 3 Tests without flasks	18300-00
1517/5	Fume Duct for 3 Tests	2875-00
1517/6	Fume Duct for 6 Tests	3550-00
1517/7	Flask Kjeldhal plain neck 300ml	270-00
1517/8	Flask Kjeldhal plain neck 500ml	460-00
1517/9	Flask Kjeldhal plain neck 800ml	580-00

1518 Kjeldhal Digestion Unit, "LABCO", complete with heating box fume duct. 500 watts heaters are 6 inches apart having individual ON/OFF switches & energy regulators. The height of the side clamps provided, is adjustable to accommodate Kjeldhal flasks of 300/500 or 800ml with specially designed fume duct to totally avoid leakage of fumes with 24/29 cone adapters for opening suitable to fit Kjeldhal Flasks having 24/29 sockets.

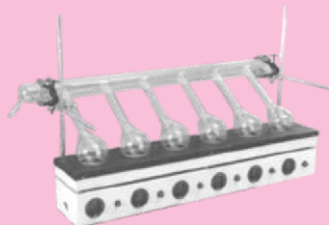

1518/1S	Unit with individual energy Regulator for 3 Tests with 3 x 500ml Kjeldhal flasks	14700-00
1518/2	Unit with individual energy Regulator for 3 Tests without flasks	12500-00
1518/3S	Unit with individual energy Regulator for 6 Tests with 6 x 500ml Kjeldhal flasks	24000-00
1518/4	Unit with individual energy Regulator for 6 Tests without flasks	21500-00
1518/5	Specially designed Fume Duct with adapters, for 3 Test of Cat. No. 1518/1S and 1518/2	3900-00
1518/6	Specially designed Fume Duct with adapters, for 6 Test of Cat. No. 1518/3S and 1518/4	6400-00
1518/7	Kjeldhal Flasks suitable for above unit 300ml capacity with 24/29 socket	340-00
1518/8	-- Do -- 500ml with 24/29 socket	590-00
1518/9	-- Do -- 800ml with 24/29 socket	690-00

KJELDHAL DISTILLATION UNIT

1519 Kjeldhal Distillation Unit, "LABCO", Complete with mild steel tubular stand provided with one heating Box, Brass Condenser rack with water circulation system, condenser clamps. Heater box is provided with top to receive the Kjeldhal flask, with electric heating elements of 500 watts each connected through ON/OFF switches and energy regulators, supplied with or without glass parts.

1519/1	Unit with individual energy Regulator for 3 Tests w/o glass parts	13250-00
1519/2S	-- do -- Same as above with glass parts	20500-00
1519/3	Unit with individual energy Regulator for 6 Tests w/o glass parts	18750-00
1519/4S	-- do -- Same as above with glass parts	33000-00
1519/5	Kjeldhal Distillation Unit Glass Parts, consisting of Kjeldhal Flask 500ml, multiple adapter, dropping funnel, splash head, Liebig Condenser, receiving adapter & receiving flask 250ml. Complete with standard joint fittings. (set for 3 tests)	7050-00
1519/6	-- do -- Same as above but Set for 6 tests	14100-00

KJELDHAL DISTILLATION AND DIGESTION COMBINED

1520 Universal combined Kjeldhal distillation & Digestion unit, "LABCO", Electrically heated comprising of one single mild steel tubular stand provided with two shelves one above the other. As specially designed glass fume duct with B24 cone openings (suitable for flasks having 24/29 socket) having such provision so that no leakage of fumes takes place. One heater box having individual energy regulators for 500 watts heaters are supplied in digestion part at lower side. One heater box of above design is supplied in distillation part as the upper side. Distillation part is also provided with brass condenser rack with water circulation systems and clamps. the whole unit is operated on 220 volts AC mains.

1520/1S	Complete unit with glass parts for 6 tests	54000-00
1520/2	--do-- without glass parts for 6 tests	31500-00
1520/3S	Complete unit with glass parts for 3 tests	33600-00
1520/4	-- do -- without glass parts for 3 tests	21000-00

Note : If above apparatus required with individual energy regulators then add extra. 2400-00

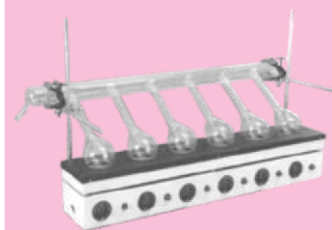

1518

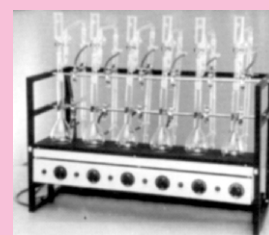

1519

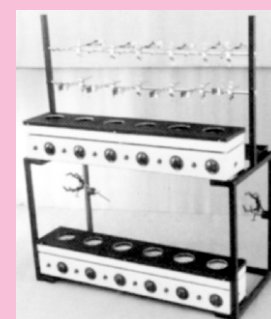

1520

SOXHLET'S EXTRACTION HEATING UNIT

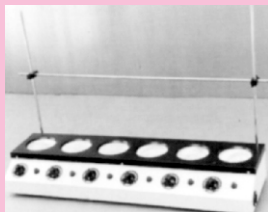

1521



1521a

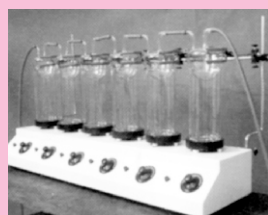

1521c



1522



1522



1523

1521 Soxhlet's extraction heating unit, "LABCO", suitable for flasks of 100ml, 150ml, 250ml, or 500ml Capacity. Unit is supplied with Heating Box fitted with Heaters (Hot Plates or Heating Mantles) individual energy regulators, neon lights, etc. adjustable rod, clamps & boss heads, but without glass parts.

1521/1	Unit with 3 Hot Plate Type Heaters	10500-00
1521/2	Unit with 6 Hot Plate Type Heaters	15500-00
1521/3	Unit with 3 Mantle Type Heaters	9200-00
1521/4	Unit with 6 Mantle Type Heaters	14000-00

1521a Colony Counter Digital 9200-00

CRUDE FIBER ESTIMATION APPARATUS

1521c Crude Fibre Estimation Apparatus, "LABCO", Hot Plate Type for 6 tests, complete with 6 x 1000ml tall form beakers, 6 bulb shape condensers, clamps and connecting rubber tube. 26000-00

HEATING MANTLES

1522 Heating Mantles, "LABCO", made of Knitted Glass yarn, heaters are fitted beneath it, which provides uniform heating of flasks upto 400°C. The mantles are fitted in a nicely painted sheet metal case, fitted with Glass Wool insulations, provided with an energy regulator, indicator and a cord.

Cat.No.	Capacity ml (W)	Watt. Rs.	Price/Piece
1522/1	50	60	2100-00
1522/2	100	60	2150-00
1522/3	250	150	2275-00
1522/4	500	200	2475-00
1522/5	1000	300	2750-00
1522/6	2000	450	3450-00
1522/7	3000	450	4275-00
1522/8	5000	600	4700-00
1522/9	10000	2x600	7300-00
1522/10	20 Litres	3x600	9600-00
1522/11	50 Litres	6x600	21800-00

SPARE MANTLES WITH HEATERS FOR REPLACEMENT

1522/12	50	60	500-00
1522/13	100	60	500-00
1522/14	250	150	510-00
1522/15	500	200	575-00
1522/16	1000	300	710-00
1522/17	2000	450	940-00
1522/18	3000	450	1025-00
1522/19	5000	600	1425-00
1522/20	10000	2x600	2175-00
1522/21	20 Litres	3x600	3800-00
1522/22	50 Litres	6x600	7900-00

TISSUE HOMOGENISER

1523 Fitted with standard high quality speed Controlled motor of 1/20 H.P. with teflon Rotor and heavy Glass Grinder well ground
 Cap. 25 ml 14500-00
 Cap. 50 ml 15200-00

HOT PLATES

1524 Hot Plates, "LABCO", Mounted on thick M.S. Sheet body a Smooth surface cast iron top, heated with an electric element of Oxidised Kanthal Wire laid under the plate **fitted with Energy Regulator** . A three stem Rotary Switch works on 220/230 AC controls Heating. The top is finished with Heat Resistant black and the body is finished scratch proof powder coating.

Cat. No.	Top Type	Dimensions Inches	Power Rating	Price/Piece Rs.
1524/1	Round (Single)	8"	1 KW	5000-00
1524/2	Round (Double)	8"	1 Kw	9500-00
1524/3	Coil Type	8"	1.5 Kw	5200-00
1524/4	Rectangular	12 x 10 x 6"	1 Kw	6700-00
1524/5	Rectangular	16 x 10 x 6"	1.5 Kw	7800-00
1524/6	Rectangular	18 x 12 x 6"	2 Kw	8400-00
1524/7	Rectangular	24 x 18 x 6"	3 Kw	14250-00

1524A Hot Plates, "LABCO", Mounted on thick M.S. Sheet body a Smooth surface of **Stainless Steel Plate** fitted with an electrically operated element laid under the plate. A three stem Rotary Switch works on 220/230 AC controls Heating.

Cat. No.	Top Type	Dimensions Inches	Power Rating	Price/Piece Rs.
1524A/1	Round	8"	1 Kw	7450-00
1524A/2	Rectangular	12 x 10 x 6"	1 Kw	9950-00
1524A/3	Rectangular	16 x 10 x 6"	1.5 Kw	11000-00
1524A/4	Rectangular	18 x 12 x 6"	2 Kw	17900-00
1524A/5	Rectangular	24 x 18 x 6"	3 Kw	39700-00

Fitted with Digital Controller (PID)

Cat. No.	Top Type	Dimensions Inches	Power Rating	Price/Piece Rs.
1524A/6	Round	8"	1 Kw	17000-00
1524A/7	Rectangular	12 x 10 x 6"	1 Kw	19700-00
1524A/8	Rectangular	16 x 10 x 6"	1.5 Kw	20900-00
1524A/9	Rectangular	18 x 12 x 6"	2 Kw	28900-00
1524A/10	Rectangular	24 x 18 x 6"	3 Kw	46700-00

PIPETTE WASHERS

1526/1 Automatic Pipette Washer, "LABCO", 63cm high, 15cm dia approx. Stainless Steel. Cylindrical Jar with syphon system, water inlet and outlet and a pipettes holding device. 8400-00

CENTRIFUGAL MACHINES

1527/1 Medico Swing out Head 4x15 ml with heavy Motor (Dome Type) 4400-00
 1527/2 -- do -- 8x15 ml 4650-00
 1527/3 Centrifugal Machine (Doctor Model) Superior Quality, 3500 RPM 4400-00
 1527/4 Centrifugal Machine Hand Driven, two tube, with ball bearings 1550-00
 1527/5 -- do -- with four tubes 1700-00



1524/1



1524/2



1524/3



1524/5



1526/1



1527/1

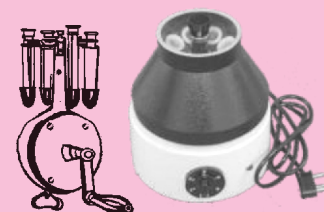

1527/4

1527/3

MELTING POINT APPARATUS



1528/1



1528/2



1530



1530/2

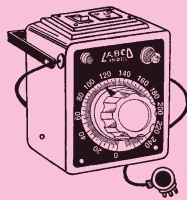

1530/3



1530/4d

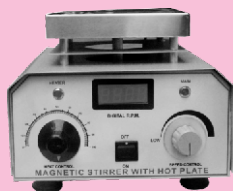

1530/4e

1528/1 Melting Point Apparatus, "LABCO", A metallic heating block heated with superior quality element. A focusable lens, shadowless lamp, regulator to control the heat. Unit is housed in a cast metal, panel fitted with neon light, ON/OFF switch & regulator, knob & a thermometer holding rod.

4100-00

1528/2 Digital Melting point Apparatus, "LABCO", Designed for Accurate determination of melting points of solid samples. Apparatus comprises of Cylindrical Silicon oil bath, built in magnetic stirrer with speed controller, electronic heat controller, Digital Temp. display with PT 100 sensor, Glass free background light with adjustable light intensity, provision for holding the melting point display.

Cat. No.	Description	Price/Piece Rs.
1528/2	Temp. range 2°C above Room Temp. to 250°C ±1.0°C, 3½ Digit LED	26000-00
1528/2A	Temp. range 2°C above Room Temp. to 250°C ±0.1°C, 4½ Digit LED	32750-00

STIRRERS AND MAGNETIC STIRRERS

1530 Laboratory Stirrer, "LABCO", Equipped with noiseless universal motor fitted with chuk, stainless steel stirring shaft fitted with three bladed propeller and retort stand having cast iron base, S.S. vertical and horizontal rods and a mount, continuous speed control for varying speed upto 4000 RPM

13250-00

1530/1 -- do -- with Digital RPM Display

17500-00

1530/2 Laboratory Stirrer Make, "LABCO", with AC/DC PMDC Motor with an arrangement to affix glass stirring rod through rubber tube. All fitted on a heavy and stable base with Thick rod at Centre, having the provision for up & down & to & fro adjustment, with speed controller (Potentiometer) to control upto minimum speed. Maximum 475 RPM

19500-00

1530/2a ---- do --- Same as above but supplied with Digital speed indicator for display of stirring speed

22500-00

1530/3 Auto Variac (Dimmerstat 2-3 Amp.)

6950-00

-- do -- 6/8, Amp

9500-00

--do -- 10/12 Amp

17500-00

1530/4 Magnetic Stirrer Heavy Duty, with Hot Plate, Extra Heavy body of Mild Steel white stoving paint, with electronic speed controller, on heavy casted base.

Cat. No.	Pan Size mm	Beaker Cap. Ltr.	Price/Piece Rs.
1530/4a	150 x 150, without Hot plate	2	6800-00
1530/4b	150 x 150, with Hot Plate & Energy Regulator	2	7850-00
1530/4c	200 x 200, without Hot Plate	5	8750-00
1530/4d	200 x 200, with Hot Plate & Energy Regulator	5	9000-00
1530/4e	With hotplate & Digital Controller & RPM Indicator	2	19700-00
1530/4f	With hotplate, Digital Temperature controller & RPM Indicator	5	20500-00
1530/4g	Rotamantle with Magnetic Stirrer	2	9500-00

SHAKING MACHINES

1531/1 Wrist Action, the machine is mounted on heavy cast iron, with the motor and speed control inside, and side wings to hold the flasks. The Shaking speed action is a variable and is controlled by regulator. **Equipped with Digital Timer**. Workable on 220 Volts AC. To hold 4 Flasks. 29000-00

1531/2 --do-- To hold 8 flasks. 30000-00

1532 Rotary Shaker, "LABCO", Base assembly made from heavy mild steel section, compact counter which helps balanced drive mechanism ensures high stability, Universal platform to accommodate interchangeable clamps of assorted sizes for holding different capacity of Glass Vessel. Speed range upto 300 RPM, time option with DC drive supplied with cord and plug to work on 220V single phase A/C.

Cat.No.	Platform Size (cms)	Holding Cap.	Price/Piece Rs.
1532/1	45 x 45	25 Flask of 100ml	32000-00
1532/2	55 x 55	25 Flask of 250ml	42000-00
1532/3	65 x 65	36 Flask of 250ml	48500-00
1532/4	105 x 105	81 Flask of 250ml	72500-00
1532/1D	45 x 45 with Digital RPM Timer)	25 Flask of 100ml	40500-00
1532/2D	55 x 55 (with Digital RPM Timer)	25 Flask of 250ml	50500-00
1532/3D	65 x 65 (with Digital RPM Timer)	36 Flask of 250ml	55600-00
1532/4D	105 x 105 (with Digital RPM Timer)	81 Flask of 250ml	79600-00

1532a V.D.R.L. Rotator, "LABCO", For V.D.R.L. and other agglutination tests, blood grouping test and for mixing of solutions in small flasks, beakers and bottles. Platform Size 300 x 300mm 7850-00

1532a/1 -- do -- With Digital RPM Metre 15900-00

1532a/2 Vortex Shaker (Test Tube Shaker) Vibration type, variable speed, Neoprene cup impart vigorous agitation to tubes, with touch ON/OFF switch 5900-00

1532b Dry bath Incubator, "LABCO", Digital Dry bath Incubator 24 holes for 12mm tubes +5°C above ambient to 100°C, Temperature sensor PT 100, maximum heating power 125w, Temperature controller PID, timer 1min. to 99 minutes, LCD display for time & temperature, Anodized Aluminum block, 220 volts A.C., Available with Buzzer alarm & Over Heat protection. 19500-00

GLASSWARE DRYER

1533 Glassware Dryer "LABCO", A powerful and heavy-duty electrically driven blower is fitted at the base. Air is forced through stainless steel pipes. Heating coils controlled through a energy regulator are provided above the blower to heat the blown air through the tubes. To work on 220 volts A.C. Supply. 48500-00



1531/1

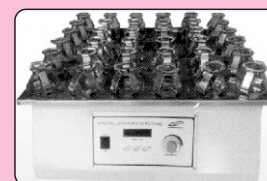

1532



1532a



1532a/2

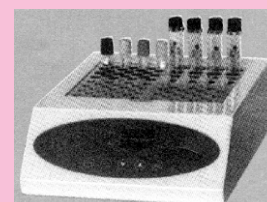

1532b



1533

WATER BATHS



1536

- 1536 Precision Water Bath High, "LABCO",** Double walled, outer mild steel sheet, Powder coated, Inner chamber of Stainless Steel, Fitted with immersion heater, stirrer with speed regulator, Glass Window, Indicators and PID temperature Controller. Temperature range 5°C above ambient to 100°C ±0.1°C. Supplied with cord.

Cat. No.	Inner Chamber Size in Inches	Price/Piece Rs.
1536/1	17 x 10.5 x 9"	41500-00
1536/2	18 x 15 x 15"	46500-00
1536/3	24 x 18 x 18"	55500-00



1537

- 1537 Water Bath Serological, "LABCO",** Double walled, outer mild steel sheet, Powder Coated, Inner Chamber of Stainless Steel with immersion heater, indicators, temperature upto 65°C ±1.0°C, is **thermostatically controlled** supplied with Pyramidal lid and cord, but without racks.

Cat. No.	Inner Chamber Size in inches	Capacity Ltr.	Price/Piece Rs.
1537/1	12 x 7 x 7"	12	7700-00
1537/2	12 x 10 x 7"	14	8450-00
1537/3	15 x 12 x 7"	18	12000-00
1537/4	18 x 12 x 7"	25	15000-00
1537/5	24 x 12 x 7"	32	17000-00



1537D

- 1537D Water Bath Serological, "LABCO",** Double walled, outer mild steel sheet, Powder Coated, Inner Chamber of Stainless Steel with immersion heater, indicators, temperature upto 65°C ±1.0°C, is controlled by **PID Digital temperature controller cum indicator** supplied with Pyramidal lid and cord, but without racks.

Cat. No.	Inner Chamber Size in Inches	Capacity Ltr.	Price/Piece Rs.
1537/1	12 x 7 x 7"	12	17900-00
1537/2	12 x 10 x 7"	14	18500-00
1537/3	15 x 12 x 7"	18	24000-00
1537/4	18 x 12 x 7"	25	25000-00
1537/5	24 x 12 x 7"	32	27000-00



1538/1

- 1538 Water Bath, "LABCO",** Thermostatically Controlled. Double walled temperature upto 95°C ±1°C, outer mild steel sheet and inner Stainless steel, with concentric rings.

Cat. No.	Description	Price/Piece Rs.
1538/1	6 Holes, Cap. 8 Ltrs.	8800-00
1538/2	12 Holes, Cap. 15 Ltrs.	12000-00
1538/3	Single wall 6 Holes w/o thermostat	4900-00
1538/4	Single wall 12 Holes w/o thermostat	6800-00



1538/3

- 1538D Water Bath, "LABCO",** Temp. is viewed & Controlled by **Digital Temperature indicator cum Controller (Microprocessor Based)**, Double walled temperature upto 95°C ±1°C, Outer Mild steel sheet and inner Stainless steel, with concentric rings.

Cat. No.	Description	Price/Piece Rs.
1538D/1	6 Holes, Cap. 8 Ltrs.	21000-00
1538D/2	12 Holes, Cap. 15 Ltrs.	23700-00



1538D

1539 Water Bath Universal, "LABCO", Temp. is controlled by **Hydraulic Thermostat**, Double walled, stainless steel chamber, one pyramidal lid and other rectangular with holes covered with cocentric rings, provided with water over flow arrangement, immersion heater pilot lamp and ON/OFF switch.

Cat. No.	Inner Chamber Size in Inches	Capacity Ltr.	Price/Piece Rs.
1539/1	12 x 9 x 7"	14	10500-00
1539/2	18 x 12 x 7"	25	14700-00

1539D Water Bath Universal, "LABCO", Temp. is viewed & Controlled by **Digital Temperature Indicator cum Controller (Microprocessor Based)** Double walled, stainless steel chamber, one pyramidal lid and other rectangular with holes covered with concentric rings, provided with water over flow arrangement, immersion heater pilot lamp and ON/OFF switch.

Cat. No.	Inner Chamber Size in Inches	Capacity Ltr.	Price/Piece Rs.
1539D/1	12 x 9 x 7"	14	21700-00
1539D/2	18 x 12 x 7"	25	25250-00

1540 Cylindrical Oil Bath, Double walled, inner chamber of stainless steel, duly Powder coated. The gap between two walls is fitted with high grade glass wool to minimize thermal loss. Temp. range 50° to 300° C, **temperature controlled by thermostat.** Supplied complete with plug and cord to work on 220/230 volts AC supply.

Cat. No.	Capacity Litre W	Watts Rs.	Price/Piece
1540/1	1	500	10500-00
1540/2	2	1000	10800-00
1540/3	3	1500	14700-00
1540/4	5	1500	15000-00
1540/5	10	2000	18400-00

1540D Cylindrical Oil Bath, Double walled, inner chamber of stainless steel, duly Powder coated. The gap between two walls is fitted with high grade glass wool to minimize thermal loss. Temp. range 50° to 300° C, **Digital Temp. Controller.** Supplied complete with plug and cord to work on 220/230 volts AC supply.

Cat. No.	Capacity Litre W	Watts Rs.	Price/Piece
1540D/1	1	500	21400-00
1540D/2	2	1000	21700-00
1540D/3	3	1500	25700-00
1540D/4	5	1500	26000-00
1540D/5	10	2000	29300-00



1539



1539D



15340

MUFFLE FURNACES

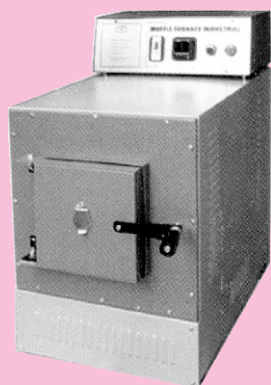

1541

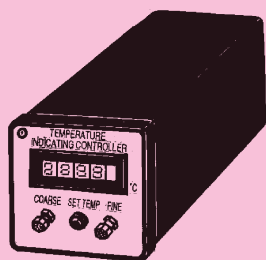

1541A



1542



1542d



1542g



1544

- 1541 **"LABCO", Laboratory Muffle Furnaces** (Light weight) Controlled, with special pressed insulation blanket, to resist the high temperature upto 1000°c (Workable temperature 900°c) Outer casing made of thick PCRC sheet, duly powder coated. Heaters made of KANTHAL A-1 wire wounded on the ceramic Muffle. Temp. is controlled by Digital Temp. Indicator cum Controller (Microprocessor Based).

Cat. No.	Inner Muffle Size in Inches	Price/Piece Rs.
1541/1	9 x 4 x 4"	32000-00
1541/2	10 x 5 x 5"	39500-00
1541/3	12 x 6 x 6"	41500-00
1541/4	12 x 8 x 8"	56000-00

- 1541A **PID Microprocessor based Digital indicator controller, "LABCO",** A unit most appropriate for temperature study & Control consisting of housing containing the PID Controller (It gives an accuracy of plus/minus 1DC), with off/on switches, lights, power indication. Range 0-100DC, 0-350DC, 0-1200DC 18500-00

DIGITAL PH / CONDUCTIVITY / TDS METER

- 1542 **Digital pH meter, "LABCO",** Auto Digital pH meter with manual temperature compensation, combination pH electrode, 3½ digit LED display. Useful for pH and Redox Potential measurements, Range 0.00 to 14.00, Touch bottom calibration (Table Model) 12500-00
- 1542a **Microprocessor based Digital pH meter, "LABCO".** 21000-00
- 1542b **Spare pH electrode either BNC type or Jack plug type, temp range 0-17DC, Resistance Mohms 200-300** 1400-00
- 1542c **Unbreakable pH electrode Gel filled BNC type of Jack plug type, temp range 0-17DC.** 3025-00
- 1542d **Digital Conductivity cum TDS meter, "LABCO",** 3½ digit LED display with facility for temp. compensation & digital cell constant adjustment along with conductivity cell (Table Model) 14500-00
- 1542e **Microprocessor based Digital conductivity /TDS/Salinity meter** 24500-00
- 1542f **Conductivity cell (Cell Constant 1)** 2450-00
- 1542g **Portable TDS Meter, "LABCO",** 3½ digit LCD display Battery operated, ABS Plastic body 7950-00

WATER STILLS (S.S.)

- 1544 **Water Stills, Manesty type, "LABCO",** Complete S.S. heavy gauge body made of SS 304, electrically operated, easily replaceable immersion type heaters and wall mounting arrangement. Output 3-4 Ltr./hr. 14500-00
- 1544A **Spare Heater for above water still** 875-00

HOT AIR OVENS

- 1546 Oven Universal, "LABCO",** temperature upto 250°C Double walled, outer body M.S. sheet duly powder coated paint, with glass wool insulation, inner chamber made of Stainless Steel Sheet, elements on three sides fitted with **imported thermostat to control temp.** +5°C ambient to 250°C ±2°C, 'L' type thermometer at the top of front, perforated adjustable shelves, two indicators, and on/off switch to work on 220/230 volts AC supplied wwith cord.

Cat. No.	Inner Chamber Size in mm	Inner Cavity Cap. in Litre	Price/Piece Rs.
1546/1	300 x 300 x 300	28	14200-00
1546/2	350 x 350 x 350	45	15000-00
1546/3	450 x 450 x 450	95	22000-00
1546/4	600 x 450 x 450	125	32200-00
1546/5	600 x 600 x 600	224	38200-00
1546/6	900 x 600 x 450	252	55500-00
1546/7	900 x 600 x 600	336	67500-00
1546/8	900 x 900 x 900	720	112500-00

Optional : Air Circulating Fan can be fitted in any of above sizes, if required at extra cost of Rs. 4700/- . Oven if required of 300°C 20% will be charged extra

- 1546D Oven Universal, "LABCO",** temperature upto 250°C Double walled, outer body M.S. sheet duly powder coated paint, with glass wool insulation, inner chamber made of Stainless Steel Sheet, elements on three sides fitted with **Microprocessor based Digital Temp. Indicator cum controller** +5°C ambient to 250°C ±1°C, perforated adjustable shelves, two indicators, fitted with Air Circulating Fan for maintaining uniform temp. throughout chamber. With on/off switch to work on 220/230 volts AC supplied with cord.

Cat. No.	Inner Chamber Size in mm	Inner Cavity Cap. in Litre	Price/Piece Rs.
1546D/1	300 x 300 x 300	28	29500-00
1546D/2	350 x 350 x 350	45	30500-00
1546D/3	450 x 450 x 450	95	37000-00
1546D/4	600 x 450 x 450	125	48000-00
1546D/5	600 x 600 x 600	224	54250-00
1546D/6	900 x 600 x 450	252	71250-00
1546D/7	900 x 600 x 600	336	82800-00
1546D/8	900 x 900 x 900	720	123500-00

Optional : Oven if required of 300°C 20% will be charged extra

VACUUM OVEN (TEMPERATURE RANGE : 50°C TO 130°C)

- 1555 Vaccum Oven, "LABCO",** Inner Chamber made of SS sheet, Front Door SS Lined outside of Mild steel duly powder coated, having small glass window with bakelite brackets. Temp. Range 50°C to 130°C with accuracy of ±1°C fitted with **Microprocessor based Digital Temp. Indicator Cum controller**, Capable of withstanding high vaccum. Provided with vaccum gauze, single shelf, Indicator lamp & on/off switch to work on 220 volts AC. (Supplied without vacuum pump)

Cat. No.	Size mm Dia. x Depth	Price/piece Rs.
1555/1	250 x 250	50000-00
1555/2	300 x 300	55000-00



1546



1546D

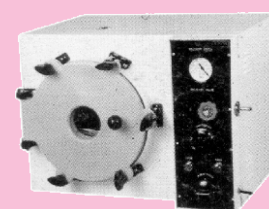

1555

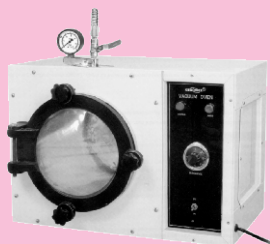

1555A

1555A Vaccum Oven, "LABCO", Hi-tech Vacuum Oven double walled. **Complete front Door made of SS 304**, Inside cylinder is made of thick stainless steel 304. Outer made of MS Sheet duly powder coated. High Grade glass wool insulation. Temperature range from 50°C to 150°C with $\pm 1^\circ\text{C}$ fitted with **Microprocessor based Digital Temp. Indicator Cum Controller**. Vacuum chamber is wrapped with a set of high quality heaters. Door has a thick tempered toughened glass window, perfectly sealed with neoprene rubber gasket, Proper door alignment to ensure excellent vacuum performance. Brackets to tighten the lid to obtain perfect seal.

Cat. No.	Size mm	Price
1555A/1	300 x 300mm	83500-00
1555A/2	300 x 500mm	90500-00

INCUBATOR BACTERIOLOGICAL



1556

1556 Incubator Universal (Mettmert Type), "LABCO", Outer body made of thick M.S. Sheet duly scratch proof powder coated paint. Double walled construction with glass wool insulation. inner Chamber made of Stainless Steel. Elements on three sides fitted with imported **Hydraulic Thermostat**. Temp. range from +5° ambient to 80°C $\pm 2^\circ\text{C}$. Fitted with main switch, pilot lamp, perforated shelves Workable on 220 volts 50Hz AC mains.

Cat. No.	Inner Chamber Size in mm	Inner Capacity in Litres	Price/Piece Rs.
1556/1	300 x 300 x 300	28	14000-00
1556/2	350 x 350 x 350	45	15000-00
1556/3	450 x 450 x 450	95	22200-00
1556/4	600 x 450 x 450	125	32500-00
1556/5	600 x 600 x 600	224	38500-00
1556/6	900 x 600 x 450	252	55500-00
1556/7	900 x 600 x 600	336	68500-00

Optional : Air Circulating Fan can be fitted in any of above sizes, if required on extra cost of Rs. 4700/-



1556D

1556D Incubator Universal (Mettmert Type), "LABCO", Outer body made of thick M.S. Sheet duly scratch proof powder coated paint. Double walled construction with glass wool insulation. Inner Chamber made of Stainless Steel. Elements on three sides fitted with **Microprocessor Based PID electronic Digital Temp. Indicator Cum Controller**. Temp. range from +5° ambient to 80°C $\pm 1^\circ\text{C}$. Fitted with Air Circulating Fan for maintaining uniform temp. throughout chamber. Fitted with main switch, pilot lamp, perforated shelves Workable on 220 volts 50Hz AC mains.

Cat. No.	Inner Chamber Size in mm	Inner Capacity Cap. in Litre	Price/Piece Rs.
1556D/1	300 x 300 x 300	28	28500-00
1556D/2	350 x 350 x 350	45	28800-00
1556D/3	450 x 450 x 450	95	36200-00
1556D/4	600 x 450 x 450	125	46500-00
1556D/5	600 x 600 x 600	224	51250-00
1556D/6	900 x 600 x 450	252	76500-00
1556D/7	900 x 600 x 600	336	92500-00



1557

1557 C.O.D. Digestion Apparatus, "LABCO", Aluminium Dry heating Block with 15 nos. cavities to accommodate 40mm dia. of tubes, heaters are placed below the block, ensures uniform heating, in a sheet metal housing, epoxy coated, temperature upto 200°C is controlled by **digital temperature indicator cum controller**, unit is fitted with timer, supplied with fifteen sets of glass reaction vessels and air condensers with standard joint fitting. 52000-00

1557A Kjeldhal Reaction Vessel, "LABCO", Cap. 100ml Centre Strong rib with B-24, Socket & Suitable Air Condensor with B-24 Cone. Size Tube O.D. x Rib O.D. x Length. 34mm x 38mm x 200mm 575-00

1557b Spare : Glass Part for C.O.D. Digestion Apparatus, per each 1set 540-00

1558 Ultrasonic Cleaner (Sonicator) "LABCO", Micro Controller based Digital Timer. With latest MOSFET base technology. Automatic frequency tuning for maximum output. Low transducer losses permit maximum cleaning action. Rugged and easy to clean stainless steel housing. Extensively protected electronics circuits for longer and safe operation. Frequency 40KHz, Input voltage range of 170AC-270AC. 50 Hz with inbuilt Digital Timer, auto degassing, SS tank fitted with drain valve, supplied with basket, with water heater and Digital Temperature controller.

Cat. No.	Tank Size, In Inches L x W x H	Capacity in Litre Approx.	Price/Piece Rs.
1558/1	6 x 5.5 x 4.5"	1.5	21800-00
1558/2	9 x 5.5 x 4"	2.5	27000-00
1558/3	12 x 6 x 4"	4	42000-00
1558/4	12 x 6 x 6"	6	59500-00
1558/5	12 x 9.5 x 6"	10	69000-00

LABORATORY AUTOCLAVE VERTICAL

1561 Laboratory Autoclave Vertical, "LABCO", Used for sterility under saturated steam pressure at any selected point between 5-15 psi. Electrically operated double walled with inner and outer body made of Stainless Steel, having radial locking arrangement. Complete with water level indicator, safety valve, water inlet and outlet system with vacuum breaker control box. Fitted with Automatic Pressure control switch, pressure gauge, steam release cock, low water auto cut off system, pilot lamp, on/off switch for operation on 220 volts AC main. Complete with stainless steel basket.

Cat. No.	Capacity Litremm	Dia x height Rs.	Price/Piece
1561/1	22	250 x 450	68500-00
1561/2	40	300 x 500	76000-00
1561/3	50	350 X 550	85000-00
1561/4	98	450 x 600	100000-00
1561/5	152	550 x 750	147000-00

VACUUM PUMPS

1565 Vacuum Pump, "LABCO", Oil sealed, air cooled, V-belt driven and mounted on base plate with belt guard etc. **DOUBLE STAGE**

Cat. No.	Displacement in Lit./Min	Motor H.P. A.C. Single Phase	Price/Piece Rs.
1565/1	32	0.25	24500-00
1565/2	50	0.25	27200-00
1565/3	75	0.50	30500-00
1565/4	100	0.50	36900-00

1565a Optional parts for above (If Required) : Moisture trap with non return valve and vacuum gauge with regulator 13500-00

1566 Vacuum Pump, "LABCO", Light weight, portable single stage 50 Lir/Min displacement, ultimate vacuum 0.05mm bar, motor 0.25 HP 16000-00

1566/1 -- do -- Double stage, ultimate vacuum 0.003m bar 22000-00

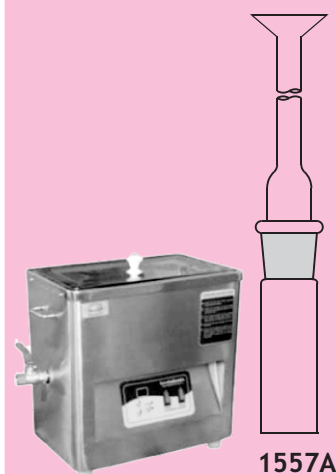

1558

1557A



1561

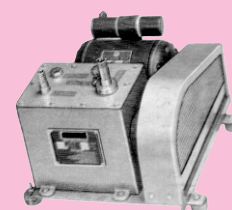

1565



1566

TEST TUBES STAND (ALLUMINIUM)



1573a

1573a Test Tube stands Alluminium, "LABCO", made from thick hardened Gauge sheet three tier highly anodized.

Cat. No.	Dia. of Hole mm	No. of Holes	Minimum Qty./Pack	Price/Piece Rs.
1573a/1	12	12	2	250-00
1573a/2	18	12	2	275-00
1573a/3	25	12	2	375-00
1573a/4	12	24	2	290-00
1573a/5	18	24	2	390-00
1573a/6	25	24	2	600-00
1573a/7	12	36	2	380-00
1573a/8	18	36	2	510-00
1573a/9	25	36	2	750-00
1573a/10	38	12	2	650-00

1573b Nessler Tube Stand for 50 ml 625-00

1573c --- do --- for 100 ml 875-00

TEST TUBES STAND (PLEXI GLASS)

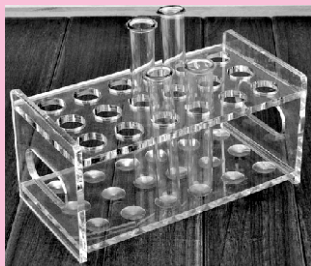

1573d

1573d "Test tubes stand" Plexi Glass, "LABCO", Made from thick Imported acrylic sheet

Cat. No.	Dia. of Hole mm	No. of Holes	Minimum Qty./Pack	Price/Piece Rs.
1573d/1	12	12	2	550-00
1573d/2	18	12	2	800-00
1573d/3	25	12	2	990-00
1573d/4	12	24	2	785-00
1573d/5	18	24	2	1425-00
1573d/6	25	24	2	1490-00
1573d/7	12	36	2	1175-00
1573d/8	18	36	2	2125-00
1573d/9	25	36	2	2235-00
1573d/10	38	12	2	1850-00

1573e Pipette Can Stainless Steel "LABCO".



1573e

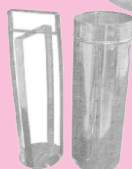

1573f

Cat No.	Dia. Height in Inches	Price/Piece Rs.	in
1573e/1	3	18	1150-00
1573e/2	4	18	1450-00

1573f Petri dish Box, S.S., to hold 10 Nos of 100mm dia dishes, with rack 1860-00

LABORATORY CLAMPS & STANDS



1574

1574 Universal Clamps, "LABCO", Sheet metal, Die-pressed, Cork lined jaws, can hold upto 12 to 50mm dia, all Brass Chrome Plated 190-00



1575

1575 Universal Clamps, "LABCO", (Condenser clamp), Made of casted alloy, cork lined jaws can hold 70mm dia, long mild steel rod for holding in the boss head. Brass Chrome Plated 490-00

1576 Burette Clamps, "LABCO", Made of thick Mild Steel Sheet, all die pressed, symmetrical, non-breakable. One holds the burette rests and other presses it due to spring force. Boss head can accommodate upto 18mm dia. rod.

Cat. No.	Description	Price/Piece Rs.
1576/1	Single-For one Burette	110-00
1576/2	Double-For two Burettes	200-00

1577 Finger Clamps (Condenser), "LABCO", Made of casted alloy, prongs cross over one another, with chrome plated 8mm dia., 175mm long mild steel rod for holding in the boss head.

Cat. No.	Description	Price/Piece Rs.
1577/1	3 Finger clamps-Hold upto 75mm dia., Alluminium Powder coated.	215-00
1577/1A	--do-- Brass, Chrome Plated	410-00
1577/2	4 Finger Clamps-Hold upto 75mm dia., Alluminium Powder coated.	215-00
1577/2A	--do-- Brass, Chrome Plated	475-00

Condenser Clamps, "JUMBO"

1577/3	4 Fingers covered with Silicon Sleeves, Jaws do not cross over, can hold upto 125mm dia. with 300 x 10mm C.P. rod. Brass casted, Chrome Plated	1475-00
1577/4	-- do -- Aluminium casted, Powder coated	625-00

1578 Condenser Clamps, "LABCO", 3 Fingers covered with Silicon Sleeves, two keys independently operated, chrome plated mild Steel Rod 300 x 10mm

Cat. No.	Description	Price/Piece Rs.
1578/1	Aluminium alloy, Powder coated	520-00
1578/2	Brass casted, Chrome plated	830-00

1579 Condenser Clamp, "LABCO", Co-axial, 3 Fingers covered with silicon sleeves, can hold from 18mm to 75mm dia. with 300 x 10mm C.P. Rod.

Cat. No.	Description	Price/Piece Rs.
1579/1	Brass casted, Chrome plated	650-00
1579/2	M.S. Sheet, Powder coated	515-00

1580 Retort Clamps, "LABCO", Cork lined cylindrical jaws, can hold upto 50mm, with 175 x 8mm Chrome plate M.S. Rod.

Cat. No.	Description	Price/Piece Rs.
1580/1	Aluminium casted, Powder coated	185-00
1580/2	Brass casted, Chrome plated	410-00

1581 Boss Head, "LABCO", Cast Iron Black Painted, with C.P. Screws

Cat. No.	Description	Price/Piece Rs.
1581/1	To hold upto 12 mm dia. rod	98-00
1581/2	To hold upto 16 mm dia. rod	150-00
1581/3	To hold upto 25 mm dia. rod	195-00
1581/4	Die Pressed	63-00

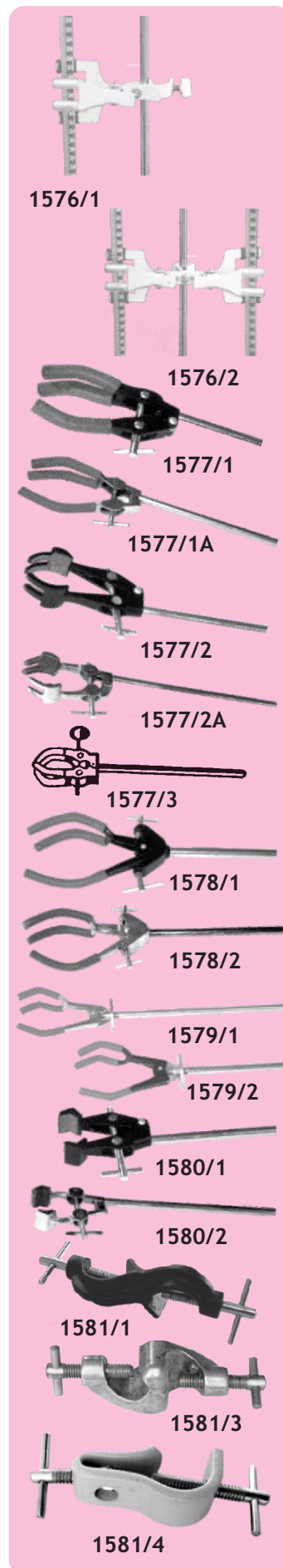



1582/6



1582



1582/7



1583



1584

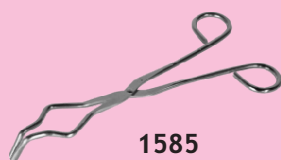

1585



1586

1582 Stands, "LABCO", Made of cast iron base with vertical rod

Cat. No.	Base size	Rod size Length x Dia.	Base Powder Coated and Rod of Stainless Steel	Base Powder Coated and Rod of Mild Steel
1582/1	6" x 4"	18" x 3/8"	550-00	440-00
1582/2	7" x 5"	24" x 1/2"	700-00	600-00
1582/3	8" x 5"	44" x 1/2"	725-00	625-00
1582/4	9" x 6"	30" x 1/2"	975-00	850-00
1582/5	12" x 7"	36" x 1/2"	1585-00	1300-00

Triangular Hammerton painted base, with mild steel chrome plated rod

Cat. No.	Base Size in Inches	Rod Size Length x Dia.	Price/Piece Rs.
1582/6	9"	24" x 1/2"	775-00
1582/7	15"	36" x 3/4"	2875-00
1582/8	6.5" Side (A Base)	24" x 1/2"	820-00

1583 Tripod Stand, "LABCO", Made of Heavy Cast Iron top triangular three balanced screwed legs.

Cat. No	Size	Superior Quality
1583/1	6" x 4"	118-00
1583/2	8" x 4"	130-00
1583/3	8" x 5"	175-00

1584 Retort Rings, "LABCO", Made of cast iron with fixed boss head to take up 12 mm dia rod

Cat. No.	Size In Inches	Price/Piece Rs.
1584/1	2"	115-00
1584/2	3"	120-00
1584/3	4"	130-00
1584/4	5"	150-00
1584/5	6"	170-00

1585 Crucible Tongs Die pressed, "LABCO" Stainless Steel

Cat.No.	Length In Inches	Price/Piece Rs.
1585/1	6"	88-00
1585/2	8"	110-00
1585/3	12"	285-00
1585/4	18"	410-00
1585/5	24"	920-00

1586 Spatula Stainless Steel, "LABCO", one end flat, one end spoon.

Cat. No.	Size Inches	Minimum Qty./Pack	Price/Piece Rs.	in
1586/1	4"		10	25-00
1586/2	6"		10	28-00
1586/3	8"		10	38-00
1586/4	10"		10	54-00
1586/5	12"		10	88-00

1586A Spatula S.S wire type, "LABCO",

Cat. No. Inches	SizeMinimum Qty./Pack	Price/Piece Rs.	in
1586A/1	6"	10	40-00
1586A/2	8"	10	68-00

1586b Sampling Spoon, "LABCO", All stainless steel 1975-00

1587 Tongs for holding Flasks, "LABCO", 12" long S.S 285-00

1588 Tongs for holding Beakers, "LABCO", 12" long S.S 285-00

1588A Scissor, "LABCO", Superior quality, Sharp ends, all S.S.

Cat. No. Inches	SizeMinimum Qty./Pack	Price/Piece Rs.	in
1588A/1	4"	10	170-00
1588A/2	5"	10	220-00
1588A/3	6"	10	300-00

1588B Forceps, "LABCO", Pointed S.S.

Cat. No. Qty./Pack	SizeMinimum Rs.	Price/Piece	mm
1588B/1	100	10	125-00
1588B/2	150	10	145-00

1589 Bunsen Burner, "LABCO", Made of thick Brass pipe 12mm dia., chrome plated, Screw type air Regulator. Painted heavy base, 150mm height approx. 260-00

1589A -- do-- with stopcock 355-00

1589B Electric Bunsen Burner 12250-00

1590 Mecker Burner, "LABCO", Made of chrome plated brass tube, Painted cast iron base, Height 180mm Approx, top dia 25mm with mesh, without stopcock 725-00

1590A ---- do --- with stopcock 825-00

1591 Teclu Burner, "LABCO", Made of Chrome plated brass tube with regulating cone, gives a powerful flame and higher temp., Painted cast iron base, height 160mm approx., with stopcock 995-00

(Please mention the gas to be used, while placing order for Burner against Cat. No. 1589 to 1591)

1592 Cork Boring Machine, "LABCO", Casted Body, hand operated with screw type shaft. With cork borer set of 12 and an ejector 8400-00

1593 Cork Borers, "LABCO", All Brass Chrome plated

Cat. No.	Set ofPattern Rs.	Price/Piece	
1593/1	3	Heavy	675-00
1593/2	6	Heavy	1325-00
1593/3	12	Heavy	2650-00

1593A Swan Neck Tap, "LABCO", Brass Chrome plated

Cat. No	Type	Superior Quality
1593A/1	One Way	1375-00
1593A/2	Two Way	2450-00
1593A/3	Three Way	3000-00



1586A

1587



1588



1588a

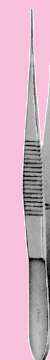

1588b



1589



1590



1591



1592



1593



1593A

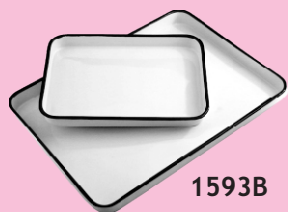

1593B

1593B Enameled Tray, "LABCO", heavy type with tapered border ends.

Cat. No. Inches	SizeMinimum Qty./Pack	Price/Piece Rs.	in
1593B/1	6" x 8"	6	315-00
1593B/2	8" x 10"	6	430-00
1593B/3	10" x 12"	6	470-00
1593B/4	12" x 14"	6	620-00
1593B/5	12" x 18"	3	900-00
1593B/6	15" x 18"	3	940-00
1593B/7	18" x 24"	3	1790-00



1593C

1593C Tray with Lid Stainless Steel

Cat. No. Inches	SizeMinimum Qty./Pack	Price/Piece Rs.	in
1593C/1	9" x 6"	6	510-00
1593C/2	10" x 8"	6	598-00
1593C/3	10" x 12"	3	870-00
1593C/4	15" x 12"	3	1230-00

WEIGHT BOXES



1594

1594 Analytical Weight Boxes, "LABCO", All Brass Chromium plated Weights with ivory tipped forceps, fitted in beautifully polished box with fractional weights set.

Cat. No.	GradeRange Rs.	Price/Piece	
1594/1	Class A	1 mg to 50 gm	2000-00
1594/2	Class A	1 mg to 100 gm	2275-00
1594/3	Class A	1 mg to 200 gm	2600-00
1594/4	Class B	1 mg to 50 gm	1550-00
1594/5	Class B	1 mg to 100 gm	1800-00
1594/6	Class B	1 mg to 200 gm	2000-00
1594/7	Class A	With NABL Certificate S.S. 100 gm	10900-00
1594/8	Class A	With NABL Certificate S.S. 200 gm	13400-00



1596

1596 Physical Weight Boxes, "LABCO", All Weights Chromium Plated brass, supplied with forceps and fractional weight set fitted in polished Box.

Cat.No.	Grade	Price/Piece Rs.
1596/1	1mg to 100gm	1550-00
1596/2	1mg to 200gm	1900-00
1596/3	1mg to 500gm	3900-00
1596/4	1mg to 1000gm	7000-00
1596/5	1mg to 2000gm	12500-00

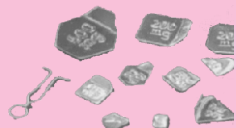

1598

1598 Analytical Fractional Weights, "LABCO", All weights rust proof nickel alloy, aluminium metal in box. Capacity 1mg to 500mg

Cat. No.	Grade	Price/Piece Rs.
1598/1	B	175-00
1598/2	A	925-00

LABORATORY RUBBERWARE

1599 Laboratory Rubber Tubing, "LABCO", Extra soft quality, Coil of 10 Meters.

Cat.No.	Approx. Bore (mm)	Wall Thickness (mm)	Price/Coil Rs.
1599/1	4.0	1.0	270-00
1599/2	5.0	1.5	330-00
1599/3	6.0	1.5	425-00
1599/4	7.0	1.5	510-00
1599/5	8.0	1.5	580-00
1599/6	9.0	2.0	680-00
1599/7	10.0	2.0	810-00
1599/8	12.0	2.5	930-00



1599

1600 High Pressure Rubber Tubing, "LABCO", Superior quality, Coil of 10 Meters

Cat.No.	ApproxWall Bore (mm)	Price/Coil Thickness (mm)	Rs.
1600/1	3.0	4.5	770-00
1600/2	4.5	4.5	910-00
1600/3	6.0	4.5	1050-00
1600/4	8.0	4.5	1325-00
1600/5	9.0	4.5	1470-00
1600/6	12.5	6.5	2250-00



1600

1600A Tube Vacuum, "LABCO", Made of pure Natural Rubber. Used for high pressure application. Wall does not collapse at high pressure application. (Available in 1mtr. Length only)

Cat. No.	I.D. mm	O.D. mm	Minimum Qty./Pack	Price/Meter/Pc Rs.
1600A/1	6	19	2	970-00
1600A/2	8	22	2	1025-00

1601 Silicon Rubber Tubing

Cat No.	O.D. mm	I.D. mm	Wall Thickness mm	Price/Coil of 5 Mtr.
1601/1	4	2	1.0	315-00
1601/2	5	3	1.0	515-00
1601/3	6	4	1.0	715-00
1601/4	7	5	1.0	865-00
1601/5	7	4	1.5	865-00
1601/6	8	6	1.0	1190-00
1601/7	8	5	1.5	1190-00
1601/8	9	6	1.5	1390-00
1601/9	10	7	1.5	1640-00
1601/10	10	6	2.0	1640-00
1601/11	11	8	1.5	1890-00
1601/12	11	7	2.0	1890-00
1601/13	12	8	2.0	1945-00
1601/14	14	10	2.0	3700-00
1601/15	14	8	3.0	4025-00
1601/16	16	12	2	4075-00
1601/17	16	10	3	4675-00
1601/18	19	12	3.5	6425-00
1601/19	23	15	4	8950-00



1601



1601a

1601A P.V.C. Tube for general Laboratory use, Petroplast, Chemical resistant Extra Soft, Roll of 30 meters.

Cat. No.	Inner Dia (mm)	Price/Roll Rs.
1601A/1	6	450-00
1601A/2	7	550-00
1601A/3	8	825-00
1601A/4	10	1385-00
1601A/5	12	1900-00
1601A/6	16	2200-00
1601A/7	19	2500-00



1602

1602 Silicon Rubber Cork

Cat. No.	Bottom Dia mm.	Top Dia mm.	Height mm.	Price/Piece Rs.
1602/1	9	11.5	20.0	16-50
1602/2	11	14.0	24.0	25-75
1602/3	13	16.0	24.0	27-75
1602/4	15	18.0	24.0	38-00
1602/5	17	20.0	26.0	46-00
1602/6	18	21.0	26.0	53-00
1602/7	19	22.5	28.0	61-00
1602/8	23	25.5	28.0	84-00
1602/9	25	28.5	28.0	102-00
1602/10	27	31.0	32.0	132-00
1602/11	29	33.0	32.0	164-00
1602/12	31	36.0	35.0	215-00
1602/13	33	38.5	38.5	292-00



1603/1-4

1603 Turnover flange Septa : These Septa ideal for moisture or air sensitive applications. When pierced with a needle, they have excellent re-sealing capability. For Test Tube **Non - Serrated**

Cat. No.	Rubber Type	For Test Tube Size (mm)	Minumum Qty./Pack	Price/Pack Rs.
1603/1	Natural	12	100	2500-00
1603/2	Natural	15	100	2950-00
1603/3	Natural	18	100	4100-00
1603/4	Natural	25	100	5000-00
1603/5	Silicon	12	10	390-00
1603/6	Silicon	15	10	490-00
1603/7	Silicon	18	10	700-00
1603/8	Silicon	25	10	840-00



1603/5-8

1603A Turnover flange Septa : These Septa ideal for moisture or air sensitive applications. When pierced with a needle, they have excellent re-sealing capability. For Socket **Non - Serrated**

Cat. No.	Rubber Type	For Socket Size (mm)	Minumum Qty./Pack	Price/Pack Rs.
1603A/1	Natural	B14	100	3950-00
1603A/2	Natural	B19	100	5400-00
1603A/3	Natural	B24	100	6450-00
1603A/4	Natural	B29	100	8150-00
1603A/5	Silicon	B14	10	640-00
1603A/6	Silicon	B19	10	1000-00
1603A/7	Silicon	B24	10	1175-00
1603A/8	Silicon	B29	10	1800-00

1604 Turnover flange Septa : These Septa ideal for moisture or air sensitive applications. When pierced with a needle, they have excellent re-sealing capability. For Test Tube **Serrated**

Cat. No.	Rubber Type	For Test Tube Size (mm)	Minumum Qty./Pack	Price/Pack Rs.
1604/1	Natural	12	100	2500-00
1604/2	Natural	15	100	2950-00
1604/3	Natural	18	100	4100-00
1604/4	Natural	25	100	5000-00
1604/5	Silicon	12	10	390-00
1604/6	Silicon	15	10	490-00
1604/7	Silicon	18	10	700-00
1604/8	Silicon	25	10	840-00

1604A Turnover flange Septa : These Septa ideal for moisture or air sensitive applications. When pierced with a needle, they have excellent re-sealing capability. For Socket **Serrated**

Cat. No.	Rubber Type	For Socket Size (mm)	Minumum Qty./Pack	Price/Pack Rs.
1604A/1	Natural	B14	100	3950-00
1604A/2	Natural	B19	100	5400-00
1604A/3	Natural	B24	100	6450-00
1604A/4	Natural	B29	100	8150-00
1604A/5	Silicon	B14	10	640-00
1604A/6	Silicon	B19	10	1000-00
1604A/7	Silicon	B24	10	1175-00
1604A/8	Silicon	B29	10	1800-00

1605 Rubber Cone for filtration flask with Collar Neck.

Cat. No.	For Suitable Filter Flask (ml)	Price/Piece Rs.
1605/1	250	85-00
1605/2	500	85-00
1605/3	1000	145-00
1605/4	2000	145-00
1605/5	5000	200-00
1605/6	10000	380-00

1605A Crucible Sleeves for Glass Filtering Flask (Set of 7Pcs) 365-00

1605B Police Man Silicon Rubber 5mm hole for insert 80-00

1605C Pipette Bulb, Natural Rubber

Cat. No.	Size	Price/Piece Rs.
1605C/1	Small	22-00
1605C/2	Medium	25-00
1605C/3	Large	32-00
1605C/4	Extra Large	34-00

1605E Automizer Bulb 130-00

1605F Rubber Teat for Dropper 5.75

1605G Propiptor (Pipette Filler) 130-00

1605H Silicon Propiptor (Auto Pipette Filler) 360-00



1604/1-4



1605



1605B



1605A



1605C



1605E



1605F



1605H



1605I

1605I Rubber Sheets, used to avoid direct surface contact of Glassware product on the solid surface.

Cat. No.	Size in Inches	Rubber Type	Minimum Qty./Pack	Price/Piece Rs.
1605I/1	9.5" x 9.5" x 2.7mm	Silicon	4	1275-00
1605I/2	9.5" x 9.5" x 2.7mm	Natural	4	175-00



1606

1606 Rubber Cork extra soft quality. (Pack Of 100 pcs)

Cat. No.	Top Dia mm	Bottom Dia. mm	Height mm.	No.	Price/pack Rs.
1606/1	13.0	9.0	15.5	0	275-00
1606/2	14.0	11.0	18.5	1	335-00
1606/3	16.5	13.0	20.0	2	410-00
1606/4	19.0	14.0	21.0	3	500-00
1606/5	21.0	15.0	22.0	4	555-00
1606/6	22.5	17.5	23.0	5	635-00
1606/7	24.5	20.0	24.0	6	880-00
1606/8	26.0	20.0	27.5	7	1000-00
1606/9	26.5	21.0	27.5	8	1150-00
1606/10	28.0	21.5	31.0	9	1475-00
1606/11	30.0	26.0	32.0	10	1835-00
1606/12	33.0	29.0	32.0	11	2000-00
1606/13	34.5	30.0	34.5	12	2300-00
1606/14	38.5	31.0	37.0	13	3250-00
1606/15	41.5	32.0	42.5	14	3600-00
1606/16	43.5	34.0	40.5	15	4680-00
1606/17	45.0	35.5	36.5	16	4870-00
1606/18	49.5	40.0	40.5	17	5650-00
1606/19	53.5	48.0	33.5	18	6250-00
1606/20	58.0	44.0	45.0	19	7450-00
1606/21	60.0	51.0	56.6	20	11000-00

LABORATORY JACKS

1607 Laboratory Jacks Box Type

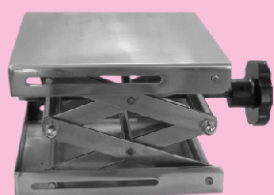

1607

Cat. No.	Height In Inches	Plate Size In Inches	MS Price/Piece	S.S. Top Price/Piece
1607/1	8"	6" x 6"	2150-00	5000-00
1607/2	14"	8" x 8"	2500-00	6900-00
1607/3	17"	10" X 10"	3650-00	9300-00
1607/4	21"	12" X 12"	4775-00	10250-00

HOFFMAN SCREW CLIPS

1608 Hoffman Screw clip, Brass Chrome plated

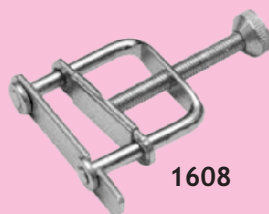

1608

Cat. No.	Size	Price/Piece	mm
1608/1	12	10	115-00
1608/2	18	10	130-00
1608/3	25	10	140-00

1608A GAS TAPS, "LABCO", Brass moulded, Copper Oxidised/Chrome Plated



1608A

Cat. No.	Type	Price/ Piece Rs.
1608a/1	One Way	740-00
1608a/2	Two Way	940-00
1608a/3	Three Way	1175-00
1608a/4	Four Way	1325-00

PORCELAIN WARE (SUPERIOR QUALITY)

1628 Porcelain Evaporating Basin (China Dishes)

Cat. No. ml	Dia.Capacity Rs.	Price/Piece	mm
1628/1	50	30	39-00
1628/2	75	100	48-00
1628/3	100	175	72-00
1628/4	125	450	185-00
1628/5	150	850	210-00



1628

1629 Porcelain Crucibles with lid

Cat. No.	Capacity ml	Price/Piece Rs.
1629/1	15	48-00
1629/2	30	58-00
1629/3	50	82-00



1629

1630 Gooch Crucibles. Tall form fixed perforated bottom, all glazed except outer bottom, without lids.

Cat. No.	Capacity ml	Price/Piece Rs.
1630/1	30	75-00
1630/2	50	96-00



1630

1631 Pestle and Mortars (Outside Glazed)

Cat. No.	Size In Inches	Price/Piece Rs.
1631/1	3"	125-00
1631/2	4"	155-00
1631/3	5"	175-00
1631/4	6"	280-00
1631/5	8"	620-00



1631

1632 Porcelain Buchner Funnels With fixed perforated plates, all glazed.

Cat. No.	Size In Inches	Price/Piece Rs.
1632/1	3"	175-00
1632/2	4"	250-00
1632/3	5"	350-00
1632/4	6"	610-00
1632/5	8"	1700-00
1632/6	12"	5200-00
1632/7	16"	12500-00



1632

1633 Spot Plate

Cat. no.	No. of cavities	Price/Piece Rs.
1633/1	6	145-00
1633/2	12	150-00



1633

GENERAL LABORATORY PLASTICWARE AND RUBBERWARE



1650



1651



1652



1653



1654

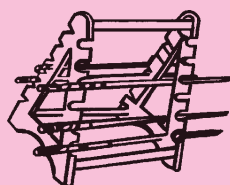

1655

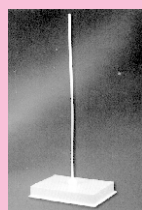

1656

1650 Beakers (Plastic) Superior quality.

Cat. No.	Capacity mlQty./Pack	Minimum Rs.	Price/Piece
1650/1	50	12	18-00
1650/2	100	12	21-00
1650/3	250	12	36-00
1650/4	500	12	54-00
1650/5	1000	6	88-00
1650/6	2000	6	178-00
1650/7	5000	6	600-00

1651 Wash Bottles (Plastic).

Cat. No.	Capacity mlQty./Pack	Minimum Rs.	Price/Piece
1651/1	250	12	54-00
1651/2	500	6	72-00
1651/3	1000	6	125-00

1652 Reagent Bottle Narrow Mouth.

Cat. No.	Capacity mlQty./Pack	Minimum Rs.	Price/Piece
1652/1	60	12	25-00
1652/2	125	12	33-00
1652/3	250	12	52-00
1652/4	500	12	65-00
1652/5	1000	6	125-00

1653 Reagent Bottles wide mouth

Cat. No.	Capacity mlQty./Pack	Minimum Rs.	Price/Piece
1653/1	60	12	26-00
1653/2	125	12	36-00
1653/3	250	12	60-00
1653/4	500	12	77-00
1653/5	1000	6	136-00

1654 Dropping Bottles

Cat. No.	Capacity mlQty./Pack	Minimum Rs.	Price/Piece
1654/1	60	12	30-00
1654/2	120	12	39-00

1655 Pipette Stand

Cat. No. Qty./Pack	Type	Minimum Rs.	Price/Piece
1655/1	Horizontal	6	215-00
1655/2	Vertical	1	660-00

1656 Retort Stand Polypropylene, Non Corrosive, moulded Rod measuring – 12.5mm x 750mm

Cat. No.	Base Size (mm)	Minimum Qty./Pack	Price/Piece Rs.
1656/1	225mm x 150mm with side hole	1	660-00
1656/2	300mm x 200mm with Central hole	1	1120-00

1657 Fisher Clamp, Polypropylene to hold the burette vertically, Non-Corrosive

Cat. No. Qty./Pack	For Minimum Rs.	Price/Piece	
1657/1	Single Burette	1	90-00
1657/2	Double Burette	1	185-00

1658 Flask Stand, Polypropylene, provides excellent support to the round bottom flask upto 10 litre Cap. 200-00Ea**1659 Pipette Box, Polypropylene, it can hold pipettes of different lengths. 325-00Ea****1660 Funnel Filtering 60° angle**

Cat. No. Inches	Size Minimum Qty./Pack	Price/Piece Rs.	In
1660/1	2"	6	11-00
1660/2	3"	6	16-00
1660/3	4"	6	34-00

1663 Measuring Cylinder (S.Plastic)

Cat. No. Qty./Pack	Size Minimum Rs.	Price/Piece	ml
1663/1	10	12	23-00
1663/2	25	12	39-00
1663/3	50	12	48-00
1663/4	100	12	55-00
1663/5	250	6	115-00
1663/6	500	4	170-00
1663/7	1000	3	340-00
1663/8	2000	2	885-00

1664 Dessicators Plain (S.Plastic)

Cat. No.	Inner Dia. mm Qty./Pack	Minimum Rs.	Price/Piece
1664/1	150	1	1675-00
1664/2	200	1	2850-00
1664/3	250	1	3700-00
1664/4	300	1	6300-00

1665 Dessicators Vaccum (S.Plastic)

Cat. No.	Inner Dia. mm Qty./Pack	Minimum Rs.	Price/Piece
1665/1	150	1	2650-00
1665/2	200	1	4000-00
1665/3	250	1	5200-00
1665/4	300	1	7800-00

1666 Kipp's Apparatus (S.Plastic)

Cat. No.	Capacity ml Qty./Pack	Minimum Rs.	Price/Piece
1666/1	250	1	1250-00
1666/2	500	1	1500-00
1666/3	1000	1	1800-00



1657



1658

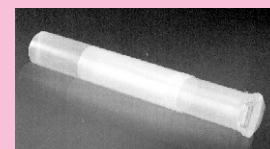

1659

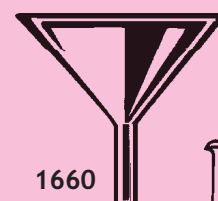

1660

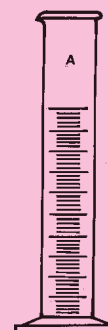

1663

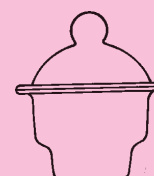

1664



1665



1666



1668

1667



1669



1670

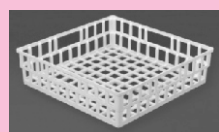

1671



1672



1673



1674



1675

1667 Pipette pump, Plastic

Cat. No.	Capacity mlQty./Pack	Minimum Rs.	Price/Piece
1667/1	2	2	460-00
1667/2	10	2	460-00
1667/3	25	2	525-00

1668 Aspirator bottle with stopcock, Good quality Plastic.

Cat. No.	Capacity LitresQty./Pack	Minimum Rs.	Price/Piece
1668/1	2	1	935-00
1668/2	5	1	1250-00
1668/3	10	1	2200-00
1668/4	20	1	3200-00

1669 Centrifuge Tube conical bottom, Polypropylene, autoclavable tubes

Cat. No.	Capacity mlQty./Pack	Minimum Rs.	Price/Piece
1669/1	15	100	18-50
1669/2	50	100	20-50

1670 Test Tube baskets, Made of polypropylene, autoclavable, unbreakable & non corrosive baskets

Cat. No. Qty./Pack	Size Rs.	Minimum Rs.	Price/Piece	mm
1670/1	140 x 120 x 110mm	6	132-00	
1670/2	160 x 160 x 160mm	6	180-00	

1671 Draining Basket, Made of polypropylene

Cat. No.	Particulars Qty./Pack	Minimum Rs.	Price/Piece
1671/1	400 x 400 x 100mm	6	660-00

1672 Measuring Jugs, with handle, moulded in polypropylene, autoclavable

Cat. No.	Capacity ml	Least Count ml	Minimum Qty./Pack	Price/Piece Rs.
1672/1	250	10	12	45-00
1672/2	500	10	12	55-00
1672/3	1000	10	6	98-00
1672/4	2000	20	6	175-00

1673 Laboratory Tray, Polypropylene

Cat. No. Qty./Piece	Size Rs.	Minimum Rs.	Price/Piece	mm
1673/1	450 x 350 x 75mm	10	460-00	
1673/2	375 x 300 x 75mm	10	330-00	

1674 Carrier Tray, Autoclavable polypropylene tray

Cat. No. Qty./Piece	Size Rs.	Minimum Rs.	Price/Piece	mm
1674/1	380 x 240 x 115mm	6	725-00	

1675 Storage Boxes, Polypropylene

Cat. No.	Capacity mlQty./Piece	Minimum Rs.	Price/Piece
1675/1	250	12	56-00
1675/2	500	12	72-00
1675/3	1000	12	92-00

1676 Coplin Jar, Material Polypropylene can hold 10 slides of size 1" x 3" back to back 50-00

1677 Cryo Box (Polycarbonate),

Cat. No.	Particulars Qty./Pack	Minimum Rs.	Price/Piece
1677/1	50 places for 1 ml or 1.8 ml Cryo Vials	8	300-00
1677/2	80 places for 1 ml or 1.8 ml Cryo Vials	4	460-00
1677/3	81 places for 4.5 ml Cryo Vials	4	625-00
1677/4	100 places for 1 ml or 1.8 ml Cryo Vials	4	530-00

PLASTICWARES AS BELOW ARE ONLY AVAILABLE WITH MIN. PACK AS MENTIONED

1700 Petri Dish, Polypropylene clear unbreakable & autoclavable

Cat. No. Qty./Pack	SizeMinimum Rs.	Price/Pack	mm
1700/1	50	36	560-00
1700/2	75	36	750-00
1700/3	100	36	900-00

1701 RIA Vial, material Polystyrene

Cat. No. Qty./Pack	SizeMinimum Rs.	Price/Pack	mm
1701/1	12 x 75mm/PS	500	1150-00
1701/2	Cap for 12mm RIA tube	100	100-00

1702 Storage Vial Leak proof, Economical options for storage material : Polypropylene

Cat. No.	Capacity mlQty./Pack	Minimum Rs.	Price/Pack
1702/1	2	500	2150-00
1702/2	5	500	3600-00

1703 'L' Shaped Spreader, Sterile smooth spreader, made of polypropylene (Pack of 100pcs) 1550-00

1704 Micro Centrifuge Tube, PP

Cat. No.	Capacity mlQty./Pack	Minimum Rs.	Price/Pack
1704/1	0.5	1000	1200-00
1704/2	1.5	500	925-00
1704/3	2.0	500	975-00

1705 CRYO Vial, "LABCO", Graduated leak proof Cap. 1.8ml PP

Cat. No.	Capacity mlQty./Pack	Minimum Rs.	Price/Pack
1705/1	1.8	1000	6900-00
1705/2	4.5	500	5000-00

1706 Dropper Pasteur Pipette "LABCO", Disposable, used to avoid cross contamination

Cat. No.	Capacity mlQty./Pack	Minimum Rs.	Price/Pack
1706	3	500	1650-00



1676

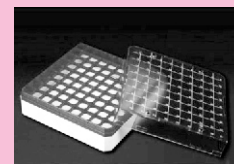

1677



1700



1701

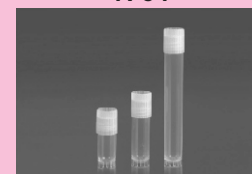

1702

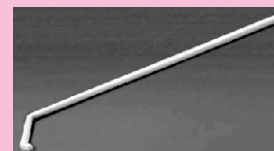

1703

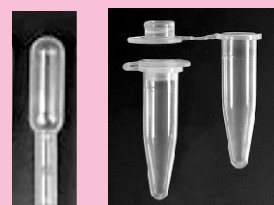

1704



1706



1705

LABORATORY SAFETY PRODUCTS DISPOSABLE WARE



1725



1726



1727



1728

1729



1730

1731



1734



1733



1735



1737

1736



1738



1739



1740



1741



1742



1743



1744

- | | | |
|------|--|--------|
| 1725 | Disposable Face Mask, "LABCO", High tearing strength, skin friendly and comfortable to wear (pack of 100pcs) | 750-00 |
| 1726 | Disposable Frill cap, "LABCO", Superior finish & water proof. Alluring look (Pack of 100pcs) | 500-00 |
| 1727 | Disposable Shoe Cover, "LABCO", Highly strong and durable (Pack of 50 Pairs) | 575-00 |
| 1728 | Disposable PVC Gloves, "LABCO", Durable & strong (pack of 100 pcs) | 165-00 |
| 1729 | Disposable Apron, "LABCO", Durable & Strong (Pack of 10pcs) | 400-00 |
| 1730 | Disposable Lab Coat, "LABCO", Durable & Strong | 115-00 |

HAND GLOVES

- | | | |
|------|---|---------|
| 1731 | Rubber Hand Gloves, "LABCO", Chemical & acid resistant Colour - Orange, Size 12" per pair | 190-00 |
| 1732 | -- do -- same as above size 14" per pair | 200-00 |
| 1733 | House Hold Rubber Hand Gloves, "LABCO", Superior quality per pair | 105-00 |
| 1734 | Nitrile Industrial Gloves, "LABCO", Durable against solvents, oil, fats and bleaching chemical agents, flocklined for easy on-off | 170-00 |
| 1735 | Heat Resistant Asbestos Gloves, "LABCO", size 12", Per pair | 1500-00 |
| 1736 | Latex Examination Disposable Gloves, "LABCO", Size -small, large or medium (box of 100 Nos) | 850-00 |
| 1737 | Nitrile Examination Hand Gloves, "LABCO", (box of 100 Nos) Size- Small, large, medium | 1400-00 |
| 1738 | Safety Hand Gloves, "LABCO", Heavy duty, cotton hosiery hand gloves. per pair | 135-00 |

SAFETY GOGGLES

- | | | |
|------|---|----------|
| 1739 | Safety Goggles, "LABCO", Routine quality | 104-00 |
| 1740 | Safety Goggles, "LABCO", Superior quality. Color white/black | 180-00 |
| 1741 | Safety Goggles, "LABCO", Chemical splash Goggles | 285-00 |
| 1742 | Safety Goggles for Glass blowing, "LABCO", This is most appropriate tool for glass blower, it saves eyes and keep cool from the dazzling sodium golden light. It is fitted with Neopham lenses | 12500-00 |
| 1743 | Safety Eye Wash Wall Mounted, "LABCO", with "C" Class heavy duty pipes of 4.05mm, Unicare Push-plate operated Eye/Face wash, fountain with twin cushion flow atomizers with pop-off covers. Automatic flow compensators. Along with set of 4 foundation Nuts & bolts | 9950-00 |
| 1744 | Eye Wash Bottle, "LABCO", Immediate flushing capability for crucial first few seconds of an eye injury by flushing the eyes in the event of an accident involving acids, caustic or other water soluble irritant. Portable light weight. available at any work place. | 550-00 |

LAB. COATS

- 1745 Cotton Lab Coat, "LABCO", Available in medium, large & XLR size. (Superior Quality) 1200-00
- 1747 PVC apron, "LABCO", Yellow PVC chemical resistant apron with eyelettes and straps to tie. Size 24" x 48" 240-00
- 1748 Chemical PVC Suit, "LABCO", Heavy duty PVC chemical splash suit 1400-00
- 1749 Superior quality 'Overall' Combination (Dangri), "LABCO", Cotton coveralls, Blue in colour, made from cotton cloth. Two chest pockets and stitched with best fabrics 1575-00



GENERAL LAB. SAFETY PRODUCTS

- 1750 Face Mask, "LABCO", Comfort fold flat style, light weight and large surface area. Use for solid particles & non oil based liquid particles from sprays. Colour - Yellow/Green (DRDO Certified N-95) 325-00
- 1751 Face Mask, "LABCO", Strong & durable. Colour -Blue (DRDO Certified N-95) 235-00
- 1752 Ear Plug, "LABCO", Soft, corded foam ear plug that conforms to the unique shape of each ear for excellent hearing protection and comfort. (pack of 10 Nos) 315-00
- 1753 Ear Muff, "LABCO". 830-00
- 1754 First Aid Box, "LABCO", Kit Casing is made of robust high grade ABS Plastic with Wall Mounting Bracket; with CE Approved Contents.
 - Complies with ANSI Z308.1-2009 Type I Standards.
 - Designed for mobile and stationary use
 2250-00



STANDARD HEATING ELEMENTS METALLIC

- 1755 Element for Water Still immersion Depth 112 MM

Cat. No.	Power KW	Price/Piece Rs.
1755/1	1	870-00
1755/2	1.5	935-00
1755/3	2	990-00

- 1756 Elements for Water Bath, for Sterlisers Nipple type

Cat. No.	Power Wattage	Price/Piece Rs.
1756/1	1000	825-00
1756/2	1500	905-00
1756/3	2000	990-00
Wattage	1000	1500
Depth	225	250
Price (Rs.)	750-00	825-00
		900-00



TERMS OF BUSINESS

- PRICES** : All the prices in the list are Ex-works Ambala and subject to market fluctuation and alteration without notice.
- PACKING & FORWARDING** : Packing, Forwarding, Freight, Insurance and other Incidental Charges extra.
- BREAKAGE** : Every possible care is taken in packing. The company is not liable for any breakage, shortage and damage in transit. All the goods are supplied at purchaser's risk.
- INSURANCE** : Since goods are fragile in nature, transit insurance may be made at an extra cost.
- GST** : **GST** will be charged extra as applicable.
- PAYMENTS** : R.R./G.R./Docket and our bill will be sent through any scheduled bank or on DOD basis. New customers are requested to send draft for 25% amount of the estimated value of order as an advance.
- ORDERS** : All orders must accompany with full instructions for dispatch, viz. the name and address of the Bank/Cargo through which the documents are to be sent. Please always mention our catalogue, number with brief description while placing your value order.
- DELIVERY** : Whereever possible we shall effect immediate delivery, otherwise 4-6 weeks time will be required to execute the order. In case of unavoidable circumstances, company is not bound to execute the order.
- DISPUTES** : All disputes are subject to Ambala Jurisdiction.

THIS CANCELS OUR ALL PREVIOUS PRICE LISTS.

Exploring the Laboratory Glassware



THE LABORATORY GLASSWARE CO.

3612, Timber Market, Ambala Cantt-133 001 (INDIA)

Factory: 73, Industrial Estate, Ambala Cantt.

PH. : (0171) 4000378

Mob: 9896000455, 9896200275

e-mail : labco_co@yahoo.in, maillabco@gmail.com

Web : www.labco.biz